

About this Manual

We've added this manual to the Agilent website in an effort to help you support your product. This manual is the best copy we could find; it may be incomplete or contain dated information. If we find a more recent copy in the future, we will add it to the Agilent website.

Support for Your Product

Agilent no longer sells or supports this product. Our service centers may be able to perform calibration if no repair parts are needed, but no other support from Agilent is available. You will find any other available product information on the Agilent Test & Measurement website, www.tm.agilent.com.

HP References in this Manual

This manual may contain references to HP or Hewlett-Packard. Please note that Hewlett-Packard's former test and measurement, semiconductor products and chemical analysis businesses are now part of Agilent Technologies. We have made no changes to this manual copy. In other documentation, to reduce potential confusion, the only change to product numbers and names has been in the company name prefix: where a product number/name was HP XXXX the current name/number is now Agilent XXXX. For example, model number HP8648A is now model number Agilent 8648A.

Performance Tests and Adjustments Manual

HP 8566B Spectrum Analyzer



**HP Part No. 08566-90168
Printed in USA September 1993**

Notice.

The information contained in this document is subject to change without notice.

Hewlett-Packard makes no warranty of any kind with regard to this material, including but not limited to, the implied warranties of merchantability and fitness for a particular purpose. Hewlett-Packard shall not be liable for errors contained herein or for incidental or consequential damages in connection with the furnishing, performance, or use of this material.

Certification

Hewlett-Packard Company certifies that this product met its published specifications at the time of shipment from the factory. Hewlett-Packard further certifies that its calibration measurements are traceable to the United States National Institute of Standards and Technology, to the extent allowed by the Institute's calibration facility, and to the calibration facilities of other International Standards Organization members.

Warranty

This Hewlett-Packard instrument product is warranted against defects in material and workmanship for a period of one year from date of shipment. During the warranty period, Hewlett-Packard Company will, at its option, either repair or replace products which prove to be defective.

For warranty service or repair, this product must be returned to a service facility designated by Hewlett-Packard. Buyer shall prepay shipping charges to Hewlett-Packard and Hewlett-Packard shall pay shipping charges to return the product to Buyer. However, Buyer shall pay all shipping charges, duties, and taxes for products returned to Hewlett-Packard from another country.

Hewlett-Packard warrants that its software and firmware designated by Hewlett-Packard for use with an instrument will execute its programming instructions when properly installed on that instrument. Hewlett-Packard does not warrant that the operation of the instrument, or software, or firmware will be uninterrupted or error-free.

LIMITATION OF WARRANTY

The foregoing warranty shall not apply to defects resulting from improper or inadequate maintenance by Buyer, Buyer-supplied software or interfacing, unauthorized modification or misuse, operation outside of the environmental specifications for the product, or improper site preparation or maintenance.

NO OTHER WARRANTY IS EXPRESSED OR IMPLIED.
HEWLETT-PACKARD SPECIFICALLY DISCLAIMS THE IMPLIED WARRANTIES OF MERCHANTABILITY AND FITNESS FOR A PARTICULAR PURPOSE.

EXCLUSIVE REMEDIES

THE REMEDIES PROVIDED HEREIN ARE BUYER'S SOLE AND EXCLUSIVE REMEDIES. HEWLETT-PACKARD SHALL NOT BE LIABLE FOR ANY DIRECT, INDIRECT, SPECIAL, INCIDENTAL, OR CONSEQUENTIAL DAMAGES, WHETHER BASED ON CONTRACT, TORT, OR ANY OTHER LEGAL THEORY.

Assistance

Product maintenance agreements and other customer assistance agreements are available for Hewlett-Packard products.

For any assistance, contact your nearest Hewlett-Packard Sales and Service Office.

Safety Notes

The following safety notes are used throughout this manual. Familiarize yourself with each of the notes and its meaning before operating this instrument.

Caution

Caution denotes a hazard. It calls attention to a procedure that, if not correctly performed or adhered to, could result in damage to or destruction of the instrument. Do not proceed beyond a *caution* sign until the indicated conditions are fully understood and met.

Warning

Warning denotes a hazard. It calls attention to a procedure which, if not correctly performed or adhered to, could result in injury or loss of life. Do not proceed beyond a warning note until the indicated conditions are fully understood and met.

Instruction Manual



The **instruction manual** symbol. The product is marked with this symbol when it is necessary for the user to refer to the instructions in the manual.

General Safety Considerations

Warning

Before this instrument is switched on, make sure it has been properly grounded through the protective conductor of the ac power cable to a socket outlet provided with protective earth contact.

Any interruption of the protective (grounding) conductor, inside or outside the instrument, or disconnection of the protective earth terminal can result in personal injury.

Warning

There are many points in the instrument which can, if contacted, cause personal injury. Be extremely careful.

Any adjustments or service procedures that require operation of the instrument with protective covers removed should be performed only by trained service personnel.

Caution

Before this instrument is switched on, make sure its primary power circuitry has been adapted to the voltage of the ac power source.

Failure to set the ac power input to the correct voltage could cause damage to the instrument when the ac power cable is plugged in.

How to Use This Manual

This manual uses the following conventions:

Front-Panel Key

This represents a key physically located on the instrument.

Screen Text

This indicates text displayed on the instrument's screen.

HP 8566B Documentation Description

Included with the HP Model 8566B spectrum analyzer are manuals: The Installation and Verification Manual, the Operating and Programming Manual, and the Performance Tests and Adjustments Manual.

HP 8566B Installation and Verification Manual

HP part number 08566-90169

Contents: General information, installation, specifications, characteristics, and operation verification.

HP 8566B Operating and Programming Manual

HP part number 08566-90040

Contents: Manual and remote operation, including complete syntax and command description. **Accopanying** this manual is the seperate, pocket-sized Quick Reference Guide, HP part number 5955-8970.

HP 8566B Performance Tests and Adjustments Manual

HP part number 08566-90168

Contents: Electrical performance tests and adjustment procedures.

HP 8566B RF Section Troubleshooting and Repair Manual

HP part number 08566-90210

Contents: RF section service information.

HP 8566B IF-Display Section Troubleshooting and Repair Manual

HP part number 08566-90085

Contents: IF-Display section service information.

Contents

1. General Information	
Introduction	1-1
Instruments Covered by this Manual	1-2
Operation Verification	1-2
Option 462 Instruments	1-2
Option 857 Instruments	1-2
2. Performance Tests	
Introduction	2-1
Verification of Specifications	2-1
Calibration Cycle	2-2
Equipment Required	2-3
Performance Test Record	2-3
1. Center Frequency Readout Accuracy Test	2-4
2. Frequency Span Accuracy Test	2-8
3. Resolution Bandwidth Accuracy Test	2-12
4. Resolution Bandwidth Selectivity Test	2-14
5. Resolution Bandwidth Switching Uncertainty Test	2-17
6. Log Scale Switching Uncertainty Test	2-19
7. IF Gain Uncertainty Test	2-21
8. Amplitude Fidelity Test	2-27
9. Calibrator Amplitude Accuracy Test	2-31
10. Frequency Response Test	2-32
11. Sweep Time Accuracy Test	2-46
12. Noise Sidebands Test	2-49
13. Line-Related Sidebands Test	2-53
14. Average Noise Level Test	2-58
15. Residual Responses Test	2-61
16. Harmonic and Intermodulation Distortion Test	2-65
17. Image, Multiple, and Out of Band Responses Test	2-73
18. Gain Compression Test	2-77
19. 1st LO Output Amplitude Test	2-81
20. Sweep + Tune Out Accuracy Test	2-82
21. Fast Sweep Time Accuracy Test (<20 ms)	2-84
22. Frequency Reference Error Test	2-87
Table 2-24. Performance Test Record	2-89
Test 1. Center Frequency Readout Accuracy	2-90
Test 2. Frequency Span Accuracy Test	2-91
Test 3. Resolution Bandwidth Accuracy Test	2-92
Test 4. Resolution Bandwidth Selectivity	2-93
Test 5. Resolution Bandwidth Switching Uncertainty	2-94
Test 6. Log Scale Switching Uncertainty Test	2-95
Test 7. IF Gain Uncertainty	2-96
Test 8. Amplitude Fidelity	2-99
Test 9. Calibrator Amplitude Accuracy	2-100
Test 10. Frequency Response Test	2-101

Test 11. Sweep Time Accuracy	2-103
Test 12. Noise Sidebands Test	2-104
Test 13. Line-Related Sidebands	2-105
Test 14. Average Noise Level	2-106
Test 15. Residual Responses	2-107
Test 16. Harmonic And Intermodulation Distortion	2-108
Test 17. Image, Multiple, and Out-of-Band Responses	2-109
Test 18. Gain Compression	2-111
Test 19. 1st LO Output Amplitude	2-112
Test 20. Sweep + Tune Out Accuracy	2-113
Test 21. Fast Sweep Time Accuracy (< 20 ms)	2-114
Test 22. Frequency Reference Error Test	2-115

3. Adjustments

Introduction	3-1
Safety Considerations	3-2
Equipment Required	3-2
Adjustment Tools	3-2
Factory-Selected Components	3-3
Related Adjustments	3-3
Location of Test Points and Adjustments	3-3
1. Low-Voltage Power Supply Adjustments	3-25
2. High-Voltage Adjustment (SN 3001A and Below)	3-31
2. High-Voltage Adjustment (SN 3004A and Above)	3-41
3. Preliminary Display Adjustments (SN 3001A and Below)	3-48
3. Preliminary Display Adjustments (SN 3004A and Above)	3-56
4. Final Display Adjustments (SN 3001A and Below)	3-63
4. Final Display Adjustments (SN 3004A and Above)	3-65
5. Log Amplifier Adjustments	3-69
6. Video Processor Adjustments	3-73
7. 3 MHz Bandwidth Filter Adjustments	3-76
8. 21.4 MHz Bandwidth Filter Adjustments	3-82
9. 3 dB Bandwidth Adjustments	3-89
10. Step Gain and 18.4 MHz Local Oscillator Adjustments	3-94
11. Down/Up Converter Adjustments	3-100
12. 10 MHz Standard Adjustment (SN 2637A and Below)	3-104
12. 10 MHz Standard Adjustment (SN 2728A and Above)	3-108
13. Sweep, DAC, and Main Coil Driver Adjustments	3-113
14. 100 MHz VCXO Adjustments	3-126
15. M/N Loop Adjustments	3-132
16. YTO Loop Adjustments	3-135
17. 20/30 Loop Phase Lock Adjustments	3-146
18. RF Module Phase Lock Adjustments	3-160
19. CAL Output Adjustment	3-166
20. Last Converter Adjustments	3-169
21. Frequency Response Adjustments	3-174
22. Analog-To-Digital Converter Adjustments	3-206
23. Track and Hold Adjustments	3-209
24. Digital Storage Display Adjustments	3-212
Low-Noise DC Supply	3-218

	Crystal Filter Bypass Network Configuration	3-219
4.	Option 462	
	Introduction	4-1
	3. 6 dB Resolution Bandwidth Accuracy Test	4-2
	3. Impulse and Resolution Bandwidth Accuracy Test	4-4
	4. 6 dB Resolution Bandwidth Selectivity Test	4-10
	4. Impulse and Resolution Bandwidth Selectivity Test	4-13
	5. Impulse and Resolution Bandwidth Switching Uncertainty Test	4-16
	Test 3. 6 dB Resolution Bandwidth Accuracy Test (p/o Table 2-24, Performance Test Record)	4-18
	Test 3. Impulse and Resolution Bandwidth Accuracy Test (p/o Table 2-24, Performance Test Record)	4-19
	Test 4. 6 dB Resolution Bandwidth Selectivity (p/o Table 2-24, Performance Test Record)	4-21
	Test 4. Impulse and Resolution Bandwidth Selectivity (p/o Table 2-24, Performance Test Record)	4-22
	Test 5. Impulse and Resolution Bandwidth Switching Uncertainty (p/o Table 2-24, Performance Test Record)	4-23
	9. 6 dB Resolution Bandwidth Adjustments	4-24
	9. Impulse Bandwidth Adjustments	4-27
5.	Option 857	
	Introduction	5-1
	8. Option 857 Amplitude Fidelity Performance Test	5-2
	Performance Test Record	5-6
	Test 8. Option 857 Amplitude Fidelity	5-7
6.	Major Assembly and Component Locations	
	IF-Display Section Figure Index	6-1
	RF Section Figure Index	6-2

Figures

1-1. Service Accessories, HP Part Number 08566-60001 . . .	1-9
2-1. Center Frequency Test Setup	2-4
2-2. Center Frequency Accuracy Measurement	2-6
2-3. Narrow Span Test Setup	2-8
2-4. Wide Span Test Setup	2-10
2-5. Resolution Bandwidth Measurement	2-13
2-6. 60 dB Bandwidth Measurement	2-15
2-7. Bandwidth Switching Uncertainty Measurement	2-18
2-8. Log Scale Switching Uncertainty Measurement	2-20
2-9. IF Gain Uncertainty Test Setup	2-21
2-10. IF Gain Uncertainty Measurement	2-23
2-11. Amplitude Fidelity Test Setup	2-27
2-12. Amplitude Fidelity Measurement	2-29
2-13. Calibrator Amplitude Accuracy Test Setup	2-31
2-14. Frequency Response Test Setup (100 Hz to 100 kHz)	2-33
2-15. Frequency Response Measurement (1 kHz to 100 kHz)	2-35
2-16. Frequency Response Test Setup (100 kHz to 60 MHz)	2-36
2-17. Frequency Response Measurement (100 kHz to 4 MHz)	2-37
2-18. Frequency Response Measurement (4 MHz to 60 MHz)	2-38
2-19. Frequency Response Test Setup (60 MHz to 2.5 GHz, 2 to 22 GHz)	2-39
2-20. Frequency Response Measurement (60 MHz to 2.5 GHz)	2-41
2-21. Sweep Time Accuracy Test Setup	2-46
2-22. Noise Sidebands Test Setup	2-50
2-23. Noise Sidebands Measurement	2-51
2-24. Line Related Sidebands Test Setup	2-53
2-25. Line-Related Sidebands Measurement	2-55
2-26. Average Noise Level Measurement	2-59
2-27. Residual Responses Measurement	2-62
2-28. Harmonic Distortion Test Setup	2-66
2-29. Intermodulation Distortion Test Setup	2-69
2-30. Third Order Intermodulation Products	2-71
2-31. Image, Multiple, and Out-of-Band Responses Test Setup	2-73
2-32. Gain Compression Test Setup	2-77
2-33. 1st LO Output Amplitude Test Setup	2-81
2-34. Sweep + Tune Out Accuracy Test Setup	2-82
2-35. Fast Sweep Time Accuracy (<20 ms) Test Setup	2-84
2-36. Fast Sweep Time Measurement (<20 ms)	2-85
2-37. Frequency Reference Test Setup	2-88
3-1. Low-Voltage Power Supply Adjustments Setup	3-25
3-2. IF-Display Section Adjustments (SN 3001A and Below)	3-26
3-3. IF-Display Section Adjustments (SN 3004A and Above)	3-27
3-4. Location of RF Section Low-Voltage Adjustments	3-29
3-5. High Voltage Adjustment Setup	3-32
3-6. Location of High Voltage Adjustments	3-33
3-7. Location of Label and Test Point	3-34

3-8. Location of A1A2 Components	3-36
3-9. CRT Cut-Off Voltage	3-37
3-10. Waveform at A1A3TP5	3-38
3-11. Discharging the CRT Post-Accelerator Cable	3-40
3-12. High Voltage Adjustment Setup	3-42
3-13. Location of High Voltage Adjustments	3-43
3-14. Location of A1A3 Label and Test Point	3-44
3-15. Discharging the CRT Post-Accelerator Cable	3-47
3-16. Preliminary Display Adjustments Setup	3-49
3-17. Location of A1A2, A1A4, A1A5, and A3A2	3-50
3-18. A1A2, A1A4, and A1A5 Adjustment Locations	3-50
3-19. X+ and X- Waveforms	3-51
3-20. Composite X Deflection Waveform	3-52
3-21. Rise and Fall Times and Overshoot Adjustment Waveform	3-53
3-22. 50V _{p-p} Signal	3-54
3-23. Preliminary Display Adjustments Setup	3-57
3-24. Location of A1A2 and A3A2	3-58
3-25. A1A2 Adjustment Locations	3-58
3-26. X+ and X- Waveforms	3-59
3-27. Composite X Deflection Waveform	3-60
3-28. Rise and Fall Times and Overshoot Adjustment Waveform	3-60
3-29. 50V _{p-p} Signal	3-62
3-30. Location of Final Display Adjustments on A1A2, A1A4, and A1A5	3-64
3-31. Final Display Adjustments Setup	3-65
3-32. Location of Final Display Adjustments on A1A2	3-66
3-33. Log Amplifier Adjustments Setup	3-69
3-34. Location of Log Amplifier Adjustments	3-70
3-35. Video Processor Adjustments Setup	3-73
3-36. Location of Video Processor Adjustments	3-74
3-37. 3 MHz Bandwidth Filter Adjustments Setup	3-76
3-38. Location of Center, Symmetry, and 10 Hz Amplitude Adjustments	3-78
3-39. Location of 3 MHz Peak Adjustments	3-80
3-40. 21.4 MHz Bandwidth Filter Adjustments Setup	3-82
3-41. Location of A4A4 21.4 MHz LC Filter Adjustments	3-83
3-42. Location of A4A4 21.4 MHz Crystal Filter Adjustments	3-84
3-43. Location of A4A8 21.4 MHz LC Filter and Attenuation Adjustments	3-85
3-44. Location of A4A8 21.4 MHz Crystal Filter Adjustments	3-86
3-45. Location of 3 dB Bandwidth Adjustments	3-90
3-46. Step Gain and 18.4 MHz Local Oscillator Adjustments Setup	3-94
3-47. Location of IF Gain Adjustment	3-96
3-48. Location of 10 dB Gain Step Adjustments	3-97
3-49. Location of .1 dB Gain Step, 18.4 MHz LO, and +10V Adjustments	3-98
3-50. Down/Up Converter Adjustments Setup	3-100
3-51. Location of Down/Up Converter Adjustments	3-101
3-52. 10 MHz Frequency Standard Adjustments Setup	3-105
3-53. Location of 10 MHz Standard Adjustments	3-107
3-54. 10 MHz Frequency Standard Adjustments Setup	3-109
3-55. Location of 10 MHz Standard Adjustments	3-112

3-56. Sweep and DAC Adjustments Setup	3-114
3-57. 0V to +10V Sweep Ramp at A16TP3	3-115
3-58. Location of Sweep and DAC Adjustments	3-116
3-59. Properly Adjusted DC Levels Between Sweep Ramps .	3-117
3-60. Improperly Adjusted DC Levels Between Sweep Ramps	3-117
3-61. YTO Main Coil Driver Adjustments Setup	3-120
3-62. Location of YTO Main Coil Driver Adjustments	3-121
3-63. YTO Main Coil Driver Adjustments Setup (Alternate Procedure)	3-122
3-64. 100 MHz VCXO Adjustment Setup	3-126
3-65. Location of 100 MHz VCXO Adjustments	3-127
3-66. Typical Tuning Range of A7A2 100 MHz VCXO	3-128
3-67. M/N Loop Adjustment Setup	3-132
3-68. Location of PLL Adjustments	3-133
3-69. YTO Loop Adjustment Setup	3-136
3-70. Location of Assemblies, Cables, and Test Points	3-136
3-71. All YTO Loop Service Position	3-137
3-72. Typical YTO Loop Swept Frequency Response at A11A1	3-139
3-73. A11A5 Adjustment Locations	3-140
3-74. Sampler Waveform at A11A5TP1	3-142
3-75. 30 MHz YTO Loop Sampler Response at AllJ5 IF OUT	3-143
3-76. Tuning the IF OUT Fundamental	3-144
3-77. 20/30 PLL Adjustment Setup	3-147
3-78. Location of PLL1 Adjustments	3-149
3-79. Location of PLL2 Adjustments	3-154
3-80. Location of PLL3 Adjustments	3-156
3-81. RF Module Phase Lock Adjustments Setup	3-161
3-82. Location of RF Module Phase Lock Adjustments	3-161
3-83. A Sampler Balance Adjustment Waveform	3-164
3-84. Cal Output Adjustment Setup	3-166
3-85. Location of CAL OUTPUT Adjustment	3-167
3-86. CAL OUTPUT Harmonics	3-168
3-87. Last Converter Adjustments Setup	3-170
3-88. Location of Last Converter Adjustments	3-171
3-89. Frequency Response Preliminary Adjustments Setup .	3-176
3-90. Location of Frequency Response Adjustments	3-177
3-91. Frequency Response Adjustments Setup (10 MHz to 2.5 GHz)	3-179
3-92. Typical Coarse Frequency Response (10 MHz – 2.5 GHz)	3-181
3-93. Typical Frequency Response (10 MHz – 2.5 GHz)	3-182
3-94. Frequency Response Adjustments Setup (2.0 GHz to 22.0 GHz)	3-185
3-95. Typical Coarse Frequency Response (2 GHz – 5.8 GHz)	3-187
3-96. Typical Frequency Response (2.0 GHz – 5.8 GHz)	3-188
3-97. Typical Coarse Frequency Response (5.8 GHz – 12.5 GHz)	3-191
3-98. Typical Frequency Response (5.8 GHz – 12.5 GHz) . . .	3-193
3-99. Frequency Response Adjustments Setup (18.6 to 325 GHz)	3-204
3-100. Analog-To-Digital Converter Adjustments Setup	3-206
3-101. Location of Analog-To-Digital Converter Adjustments .	3-208
3-102. Track and Hold Adjustments Setup	3-209
3-103. Location of Track and Hold Adjustments	3-210
3-104. Digital Storage Display Adjustments Setup	3-212
3-105. Location of Digital Storage Display Adjustments	3-213

3-106. Sample and Hold Balance Adjustment Waveforms . . .	3-215
3-107. Waveform Before Adjustment	3-215
3-108. Low-Noise DC Supply	3-218
3-109. Crystal Filter Bypass Network Configurations	3-219
4-1. Resolution Bandwidth Measurement	4-3
4-2. Impulse Bandwidth Test Setup	4-4
4-3. 6 dB Resolution Bandwidth Measurement	4-8
4-4. 60 dB Bandwidth Measurement	4-11
4-5. 60 dB Bandwidth Measurement	4-14
4-6. Bandwidth Switching Uncertainty Measurement	4-17
4-7. Location of Bandwidth Adjustments	4-25
4-8. Location of Bandwidth Adjustments	4-28
5-1. Option 857 Amplitude Fidelity Test Setup	5-2
6-1. RF Section, Top View	6-3
6-2. RF Section, Front View	6-4
6-3. RF Section, Bottom View	6-5
6-4. IF Section, Top View (SN 3001A and Below)	6-6
6-5. IF Section, Top View (SN 3004A and Above)	6-7
6-6. IF Section, Front View	6-8
6-7. IF Section, Bottom View	6-9

Tables

2-1. Performance Test Cross-Reference	2-2
2-2. Center Frequency Readout Accuracy	2-7
2-3. Narrow Span Accuracy	2-9
2-4. Wide Span Accuracy	2-11
2-5. Bandwidth Accuracy	2-13
2-6. Resolution Bandwidth Selectivity	2-16
2-7. Bandwidth Switching Uncertainty	2-18
2-8. Log Scale Switching Uncertainty	2-20
2-9. IF Gain Uncertainty, 10 dB Steps	2-23
2-10. IF Gain Uncertainty, 2 dB Steps	2-24
2-11. IF Gain Uncertainty, 0.1 dB Steps	2-25
2-12. Log Scale Fidelity	2-29
2-13. Linear Amplitude Fidelity	2-30
2-14. 100 Hz to 2.5 GHz Frequency Band	2-37
2-15. Frequency Response (Flatness)	2-45
2-16. Sweep Time Accuracy, Sweep Times ≥ 20 ms	2-48
2-17. Sweep Time Accuracy	2-48
2-18. Average Noise Level	2-60
2-19. TO1 Measurement Settings	2-72
2-20. Image and Out-of-Band Response	2-75
2-21. Multiple Responses	2-76
2-22. Sweep + Tune Out Accuracy	2-83
2-23. Fast Sweep Time Accuracy (< 20 ms)	2-86
2-24. Frequency Response (Flatness)	2-102
3-1. Adjustment Cross Reference	3-4
3-2. Adjustable Components	3-5
3-3. Factory-Selected Components	3-13
3-4. Standard Value Replacement Capacitors	3-20
3-5. Standard Value Replacement 0.125 Resistors	3-21
3-6. Standard Value Replacement 0.5 Resistors	3-23
3-5. Initial Adjustment Positions	3-63
3-6. Initial Adjustment Positions	3-66
3-7. Standard Values for A7A2L4	3-128
3-8. Limits for 100 MHz Harmonics	3-130
3-9. Selection Chart for Attenuator Resistors	3-130
3-10. Resistor Values	3-131
3-11. Power Level of Fundamental Signal	3-144
3-12. Standard Values for A10A4C49	3-157
3-13. Standard Values for A10A4R29 and A10A4R33	3-158
3-14. Frequency Bands	3-174
3-15. Preselector Delay Compensation DAC Values	3-202
3-16. A6A12 YTX Driver Assembly Factory-Select Capacitor Values	3-203
3-17. Parts for Low-Noise DC Supply	3-218
3-18. Crystal Filter Bypass Network Configuration for A4A4 and A4A8 (21.4 MHz)	3-219

3-19. Crystal Filter Bypass Network Configuration for A4A7 (3MHz)	3-219
4-1. 6 dB Resolution Bandwidth Accuracy	4-3
4-2. Impulse Bandwidth Accuracy	4-9
4-3. 6 dB Resolution Bandwidth Accuracy	4-9
4-4. 6 dB Resolution Bandwidth Selectivity	4-12
4-5. Impulse and Resolution Bandwidth Selectivity	4-15
4-6. Bandwidth Switching Uncertainty	4-17
5-1. Log Amplitude Fidelity (10 Hz RBW; Option 857)	5-4
5-2. Log Amplitude Fidelity (10 kHz RBW; Option 857)	5-5
5-3. Linear Amplitude Fidelity	5-5

General Information

Introduction

This HP 8566B Tests and Adjustments Manual contains two main sections: Performance Tests and Adjustments Procedures. This chapter lists the required test equipment for both sections. The performance tests provided should be performed for the following reasons:

- If the test equipment for the Operation Verification Program is not available.
- If the instrument does not pass all of the Operation Verification tests.
- For complete verification of specifications not covered by the Operation Verification program.

The adjustment procedures should be performed for the following reasons:

- If the results of a performance test are not within the specifications.
- After the replacement of a part or component that affects electrical performance.

Warning

The adjustment procedures require access to the interior of the instrument and therefore should only be performed by qualified service personnel. There are voltages at many points in the instrument which can, if contacted, cause personal injury. Be extremely careful. Adjustments should be performed only by trained service personnel.

Power is still applied to this instrument with the LINE switch in STANDBY. There is no OFF position on the LINE switch. Before removing or installing any assembly or printed circuit board, remove the power cord from the rear of both instruments and wait for the MAINS indicators (red LEDs) to go completely out.

Capacitors inside the instrument may still be charged even if the instrument has been disconnected from its source of power. Use a non-metallic tuning tool whenever possible.

Instruments Covered by this Manual

This manual contains procedures for testing and adjusting HP 8566B spectrum analyzers, including those with Option 400 (400 Hz operation), Option 462 (impulse bandwidths and 6 dB bandwidths), and Option 857 installed. The procedures in this manual can also be used to adjust HP 8566A spectrum analyzers that have been converted into HP 8566B spectrum analyzers through the installation of an HP 8566AB Retrofit Kit (formerly HP 8566A+01K Retrofit Kit).

Operation Verification

A high confidence level in the instrument's operation can be achieved by running only the Operation Verification Program, since it tests most of the instrument's specifications. It is recommended that the Operation Verification Program be used for incoming inspection and after repairs, since it requires much less time and test equipment. A description of the program can be found in the Installation and Verification manual.

Option 462 Instruments

Option 462 instruments require that the performance tests and adjustment procedures listed below be performed instead of their standard versions included in chapters two and three. Information on Option 462 versions is located in Chapter 4, Option 462.

6 dB Bandwidths:

- Test 3, 6 dB Resolution Bandwidth Accuracy Test
- Test 4, 6 dB Resolution Selectivity Test
- Adjustment 9, 6 dB Bandwidth Adjustment Procedure

Impulse Bandwidths:

- Test 3, Impulse Resolution Bandwidth Accuracy Test
- Test 4, Impulse and Resolution Selectivity Test
- Test 5, Impulse and Resolution Bandwidth Switching Uncertainty Test
- Adjustment 9, Impulse Bandwidth Adjustment Procedure

Option 857 Instruments

Option 857 instruments are used in EMC receiver applications. Information on Option 857 is located in Chapter 5, Option 857.

Table 1-1. Recommended Test Equipment (1 of 6)

Instrument	Critical Specifications for Equipment Substitution	Recommended Model	Perf. Test	Adj.
SIGNAL SOURCES Synthesized Sweeper	Frequency: 10 MHz to 22 GHz Output Power: + 10 dBm maximum (leveled) Aging Rate: $<1 \times 10^{-9}/\text{day}$ Spurious Signals: $\leq 35 \text{ dBc}$ ($<7 \text{ GHz}$) $\leq 25 \text{ dBc}$ ($<20 \text{ GHz}$) Amplitude Modulation: dc to 100 kHz Leveling: Internal, External Power Meter	HP 8340A/B	X	X
Synthesized Signal Generator	Frequency: 2 – 18 GHz Stability: $<5 \times 10^{-10}$	HP 8672A	X	X
Frequency Synthesizer	Frequency: 200 Hz to 80 MHz Stability: $\pm 1 \times 10^{-8}/\text{day}$ Amplitude Range: + 13 to -86 dBm with 0.01 dB resolution Attenuator Accuracy: $< \pm 0.07 \text{ dB}$ (+ 13 to -47 dBm)	HP 3335A	X	X
Pulse Generator	Pulse Width: 10 nsec to 250 nsec Rise and Fall Times: $<6 \text{ ns}$ Output Level: +2.5V	HP 8116A		X
Function Generator	Output: Sine Wave and Triangle Wave, 2Vp-p Range: 100 Hz to 500 kHz (Sweep Function Available) (2 required)	HP 3312A	X	X
Frequency Standard	Output: 1, 2, 5, or 10 MHz Accuracy: $< \pm 1 \times 10^{-10}$ Aging Rate: $< 1 \times 10^{-10}/\text{day}$	HP 5061B	X	X

Table 1-1. Recommended Test Equipment (2 of 6)

Instrument	Critical Specifications for Equipment Substitution	Recommended Model	Perf Test	Adj
ANALYZERS				
Spectrum Analyzer	Frequency: 100 Hz to 2.5 GHz 2 to 22 GHz Preselected	HP 8566A/B	X	X
Active Probe	Resistive Divider for measuring fast transition signals	HP 10020A		X
Probe Power Supply	For use with HP 10020A	HP 1122A		X
High Frequency Active Probe	Bandwidth: 5 Hz to 500 MHz Input R: 100 k Ω Input C: 3 pF	HP 41800A		X
COUNTERS				
Frequency Counter	Frequency: 20 MHz to 400 MHz Sensitivity: -30 dBm HP-IB Compatible	HP 5343A		X
Electronic Counter	Range: >10 MHz Resolution: 2×10^{-9} gate time Ext. Time Base: 1, 2, 5, or 10 MHz	HP 5345A	X	
Universal Counter	Frequency: dc to 100 MHz Time Interval A \rightarrow B: 100 ns to 200s sensitivity: 50 mV rms Range: 30 mV to 5V p-p	HP 5316B HP 5334A/B	X	
OSCILLOSCOPE				
Digitizing Oscilloscope	1 Channel Frequency: 100 MHz sensitivity: .005V/Division	HP 54501A		X
Oscilloscope Probe	10:1 Divider, compatible with oscilloscope (2 required)	HP 10432A		X

Table I-1. Recommended Test Equipment (3 of 6)

Instrument	Critical Specifications for Equipment Substitution	Recommended Model	Perf. Test	Adj
METERS				
Digital Voltmeter	Resolution: f0.1 mV Range: 0 Vdc to 100 Vdc Input Impedance 100 V Range: 10 MΩ HP-IB Compatible	HP 3456A or HP 3455A	X	X
DC High Voltage Probe	1000: 1 Divider Impedance: 10MΩ	HP 34111A		X
Power Meter	Range: -20 dBm to + 10 dBm Accuracy: ±0.02dB	HP436A	X	X
Power Sensor	Frequency: .01 to 18 GHz Compatible with HP 436A Power Meter	HP 8481A		X
Power Sensor	Frequency: 50 MHz to 26.5 GHz Compatible with HP 436A Power Meter	HP8485A	X	
Digital Photometer		Tektronix J-16 Option 02		X
Photometer Probe	for Tektronix J-16 range: 1 to 100 NITS (cd/m ^s) acceptance angle: 8° spectral response: CIE Photopic curve	Tektronix 56503		X
Interconnect Cable	for Tektronix J-16	Tektronix 012-0414-02		X
Photometer Light Occluder	Por Tektronix J-16	Tektronix 016-0305-00		X
ATTENUATORS				
10 dB Step Attenuator	Steps: 10 dB from 0 to 120 dB Frequency: 20 MHz to 1500 MHz Calibrated to uncertainty error of ±(0.02 dB + 0.01 dB/10 dB step) at 20 MHz from 0 dB to 120 dB	HP 355D-H89		X

Table 1-1. Recommended Test Equipment (4 of 6)

Instrument	Critical Specifications for Equipment Substitution	Recommended Model	Perf. Test	Adj.
1 dB Step Attenuator	Steps: 1 dB from 0 to 12 dB Frequency: 20 MHz to 1500 MHz Calibrated to uncertainty error of f(0.02 dB + 0.01 dB/10 dB step) at 20 MHz from 0 dB to 12 dB	HP 355C-H25		X
3 dB Attenuator	Frequency: 200 Hz to 18 GHz SMA Connectors	HP 8493B, Option 003	X	
20 dB Attenuator	Frequency: 200 Hz to 18 GHz SMA Connectors (<i>2 required</i>)	HP 8493B, Option 020	X	
TERMINATIONS				
Termination	Impedance: 50Ω; BNC	HP 11593A		X
Termination	Impedance: 50Ω; SMA (m)	HP 1810-0118		X
Termination	Type N Male Connector Frequency: dc to 18 GHz Impedance: 50Ω	HP 909A, Option 012	X	
FILTERS				
Low-Pass Filter	Cut-off Frequency: 250 MHz Rejection at 460 MHz: >60 dB	K&L 5L380- 250-B/B	X	
Low-Pass Filter	Cut-off Frequency: 8 GHz Rejection at 14 GHz: >80 dB	K&L 6L250- 8000-NP/N	X	
Low-Pass Filter	Cut-off Frequency: 1200 MHz Rejection at 1500 MHz: >50 dB	HP 360B	X	
MISCELLANEOUS DEVICES				
Precision Power Supply	0-20 volts, 0-2 amperes	HP 6114A		X

Table 1-1. Recommended Test Equipment (5 of 6)

Instrument	Critical Specifications for Equipment Substitution	Recommended Model	Perf. Test	Adj.
AC Line-Power Source (For Option 400)	Frequency: 400 Hz Voltage :100, 120, 220, or 240 V _{ac} Power: >600VA	California Instruments Model 153T Opt. 400	X	
Power Splitter	Frequency: 1 MHz to 22 GHz Tracking: <0.2 dB	HP 11667B		X
Planar-doped Barrier Diode Detector	10 MHz to 33 GHz	HP 8473D/ HP 8474C		X
Reactive Power Divider	Range: 2 to 22 GHz Isolation: ≥20 dB	Omni-Spectra 2090-6202-00	X	
SPECIAL DEVICES				
Display Adjustment PC Board*	Required for preliminary display adjustment!	IP 85662-60088		X
Low-Noise DC Supply	(Optional) Refer to Figure 3-108.			X
Crystal Filter Bypass Network	Refer to Figure 3-109. (4 required)			X
CABLES				
Low-Loss Microwave Cable	APC 3.5 (m)	HP 8120-4921		X
Cable	BNC, 122 cm (48 in.) (3 required)	10503A		X
Cable	SMA (m) to SMA (m)	5061-1086	X	
Test Cable*	BNC (m) to SMB Snap-On (f)	IP 85680-60093		X

Table 1-1. Recommended Test Equipment (6 of 6)

Instrument	Critical Specifications for Equipment Substitution	Recommended Model	Perf. Test	Adj.
ADAPTERS				
Adapter	Type N (f) to BNC (m)	1250-0077	X	
Adapter	SMB snap on (m) (m)	1250-0672		X
Adapter	SMB (m) to SMA (f)	1250-0674		X
Adapter	SMB (m) bulkhead	1250-0691		X
Adapter	Type N (f) to N (f)	1250-1477	X	
Adapter	Type N (m) to N (m)	1250-0778	X	
Adapter	Type N (m) to BNC (f) (2 <i>required</i> ,	1250-0780	X	
Adapter	BNC Tee (m)(f)(f) (2 <i>required</i>)	1250-0781	X	X
Adapter	SMA (f) to SMA (f)	1250-1 158	X	
Adapter	SMA (m) to SMA (m)	1250-1159	X	
Adapter	BNC (f) to SMA (m)	1250-1200		X
Adapter	BNC (f) to SMB (f)	1250-1236		X
Adapter	Type N (m) to SMA (f)	1250-1250	X	
Adapter	BNC to aligator clip	1250-1292		X
Adapter	Type N (f) to BNC (m)	1250-1477		X
Adapter	APC-3.5 (m) to Type N (m)	1250-1743		X
Adapter	Type N (m) to APC-3.5 (f)	1250-1744		X
Adapter	APC-3.5 (f) TO N (f) (2 <i>required</i>)	1250-1745		X
Adapter	APC-3.5 (f) to APC-3.5 (f)	1250-1749		X
Adapter	APC-3.5 (m) to Type N (f)	1250-1750		X
Adapter	BNC (f) to dual bannana plug	1251-2277		X
Adapter	Type N (f) to SMA (f)	HP 86290-60005	X	
BOARD EXTENDERS				
	See Figure 1-1.			
?C Board Extractor	PC Board extracting tool	HP 03950-4001		X
* Part of Service Accessories				

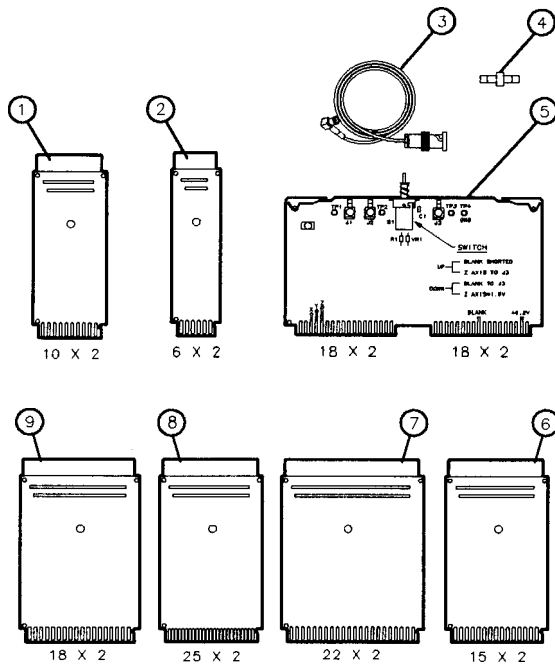

Item	Qty	Description	HP Part Number
1	1	Extender Board: 20 contacts, 2 rows of 10	85680-60028
2	2	Extender Board: 12 contacts, 2 rows of 6	08505-60109
3	2	Cable: 4-foot long; BNC to SMB snap-on	85680-60093
4	1	Adapter: SMB snap-on male to SMB snap-on male	1250-0669
5	1	PC Board: Display Adjustment Test	85662-60088
6	3	Extender Board: 30 contacts; 2 rows of 15	08505-60041
7	1	Extender Board: 44 contacts; 2 rows of 22	08505-60107
8	1	Extender Board: 50 contacts; 2 rows of 25	85680-60034
9	2	Extender Board: 36 contacts; 2 rows of 18	08505-60042

Figure I-1. Service Accessories, HP Part Number 08566-60001

Performance Tests

Introduction

The procedures in this section test the instrument's electrical performance using the Specifications in the Installation and Verification Manual as the performance standards. None of the tests require access to the interior of the instrument. The manual Performance Tests provided in this section should be performed only if semi-automatic test equipment (for Operation Verification) is not available or the Performance Test is not in the Operation Verification Program. (Refer to the Installation and Verification Manual for information on Operation Verification.)

Verification of Specifications

When a complete verification of specifications is required, proceed as follows:

1. Run the Operation Verification Program.
2. The Operation Verification Program verifies compliance with specifications of all tests it performs. The tests not performed by the Operation Verification Program must be done manually and are as follows:
 - Sweep Time Accuracy (including Fast Sweep Time Accuracy)
 - Noise Sidebands
 - Harmonic and Intermodulation Distortion
 - Image, Multiple, and Out-of-Band Responses
 - Frequency Reference Error
 - Center Frequency Readout Accuracy

If the results of a performance test are marginally within specification, go to the Adjustments section of this manual and perform the related adjustments procedures. When an adjustment is directly related to a performance test, the adjustment procedure is referenced under RELATED ADJUSTMENT in the performance test.

Table 2-1. Performance Test Cross-Reference

Function or Characteristic Tested	Test No.	Performance Test
Center Frequency Readout	1	Center Frequency Readout Accuracy Test
Frequency Spans	2	Frequency Span Accuracy Test
3-dB Bandwidths*	3	Resolution Bandwidth Accuracy Test
Bandwidth Shape*	4	Resolution Bandwidth Selectivity Test
Bandwidth Amplitudes*	5	Resolution Bandwidth Switching Uncertainty Test
Log Scales	6	Log Scale Switching Uncertainty Test
IF Gains	7	IF Gain Uncertainty Test
Log and Linear Amplifier Fidelity†	8	Scale Fidelity Test
CAL OUTPUT Level	9	Calibrator Amplitude Accuracy Test
Frequency Response	10	Frequency Response Test
Sweep Times	11	Sweep Time Accuracy Test
Noise Sidebands	12	Noise Sidebands Test
Line-Related Sidebands	13	Line-Related Sidebands Test
Noise Floor	14	Average Noise Level Test
Residual Responses	15	Residual Responses Test
Harmonic and Intermodulation Distortion	16	Harmonic and Intermodulation Distortion Test
Image, Multiple, and Out-of-Band Responses	17	Image, Multiple, and Out-of-Band Responses Test
Gain Compression	18	Gain Compression Test
1ST LO OUTPUT Amplitude	19	1ST LO OUTPUT Amplitude Test
SWEEP+ TUNE OUT	20	SWEEP + TUNE OUT Amplitude Test
Fast Sweep Times	21	Fast Sweep Time Accuracy Test (<20 ms)
Frequency Reference	22	Frequency Reference Error Test
*For Option 462 instruments, refer to Chapter 4. †For Option 857 instruments, refer to Chapter 5.		

Calibration Cycle This instrument requires periodic verification of performance. The instrument should have a complete verification of specifications at least every six months.

Equipment Required

Equipment required for the manual performance tests and adjustments is listed in **Table 1-1, Recommended Test Equipment**. Any equipment that satisfies the critical specifications given in the list may be substituted for the recommended model.

Performance Test Record

The Operation Verification Program provides a detailed test record when a printer is used with the controller. If manual performance tests are done, the results of the performance tests may be tabulated on the HP 8566B Performance Test Record at the end of this chapter. The HP 8566B Performance Test Record lists all of the tested specifications and the acceptable ranges for the measurement values obtained during the tests.

Note

Allow 1/2 hour warm up time for the HP 8566B before beginning the Performance Tests.

1. Center Frequency Readout Accuracy Test

Related Adjustments 10 MHz Standard Adjustment
Sweep, DAC, and Main Coil Driver Adjustments

Specifications For spans $\leq n \times 5$ MHz, \pm (2% of frequency span + frequency reference error \times center frequency + 10 Hz).
For spans $> n \times 5$ MHz, \pm (2% of frequency span + $n \times 100$ kHz + frequency reference error \times center frequency).

n*	Center Frequency
1	100 Hz to 5.8 GHz
2	5.8 GHz to 12.5 GHz
3	12.5 GHz to 18.6 GHz
4	>18.6 GHz

* n is the harmonic mixing number, depending on center frequency.

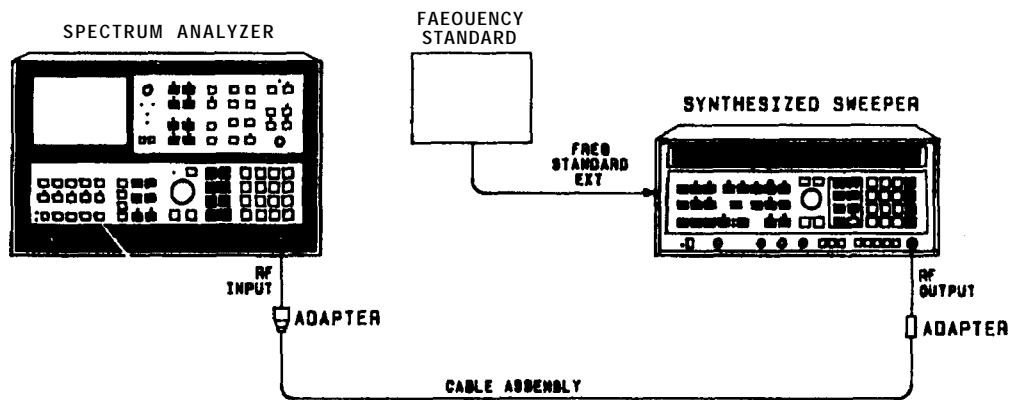

Figure 2-1. Center Frequency Test Setup

1. Center Frequency Readout Accuracy Test

Description A synthesized signal source that is phase-locked to a known frequency standard is used to input a signal to the analyzer. The frequency readout of the analyzer is compared to the actual input frequency for several different frequency settings over the analyzer's range. The signal source is phase-locked to a standard known to be as accurate as the analyzer's internal frequency reference to minimize the "frequency reference error X center frequency" term of the specifications.

Equipment

Synthesized Sweeper	HP 8340A
Frequency Standard	a 10 MHz standard with accuracy within ± 1 part in 10^{10} such as HP 5061A
Adapter, Type N (m) to SMA (f) ,	1250-1250
Adapter, SMA (f) to SMA (f)	1250-1158
Cable Assembly, SMA Male Connectors	5061-1086

- Procedure**
1. Connect CAL OUTPUT to RF INPUT.
 2. Press **2 - 22 GHz**, **RECALL** **9**.
 3. Adjust **FREQ ZERO** for a maximum amplitude trace.
 4. Press **2 - 22 GHz**.
 5. Set the synthesized sweeper for a 2.000000 GHz signal at a level of approximately 0 dBm.
 6. Connect equipment as shown in Figure 2-1.
 7. Set analyzer **CENTER FREQUENCY** and **FREQUENCY SPAN** and synthesized sweeper frequency according to Table 2-2. At each setting, press **PEAK SEARCH**, **MKR → CF** to center the signal. Adjust **REFERENCE LEVEL** as necessary to place signal peak at a convenient level.
 8. Record the **CENTER FREQUENCY** readout in the table for each setting. The limits for this frequency are given in the table. Refer to Figure 2-2.

1. Center Frequency Readout Accuracy Test

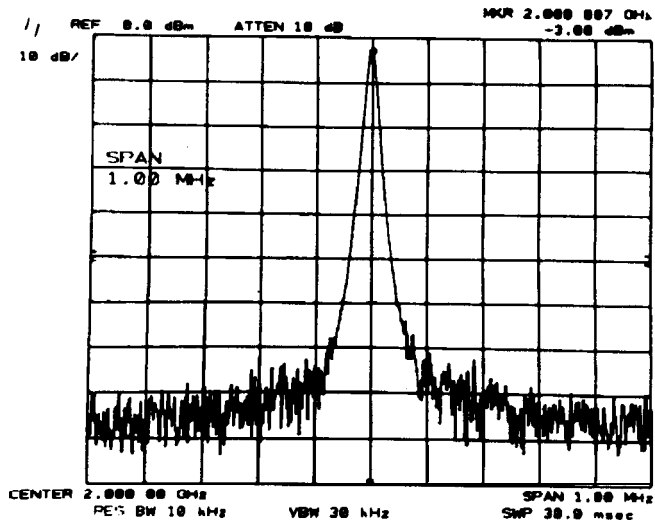

Figure 2-2. Center Frequency Accuracy Measurement

Note

The spectrum analyzer CENTER FREQUENCY readout may fall outside of the specified limits if the internal frequency reference of the analyzer has not been calibrated within the past year. To eliminate the “frequency reference error X center frequency” error, the analyzer’s 10 MHz Frequency Reference Output (on the rear panel) may be substituted for the frequency standard.

1. Center Frequency Readout Accuracy Test

Table 2-2. Center Frequency Readout Accuracy

synthesized Sweeper Frequency	(FREQUENCY SPAN)	(CENTER FREQUENCY)	Center Frequency Readout		
			Min	Actual	Max
2 GHz	1 MHz	2 GHz	1.999 98 GHz		2.000 02 GHz
2 GHz	10 MHz	2 GHz	1.999 7 GHz		2.000 3 GHz
2 GHz	100 MHz	2 GHz	1.998 GHz		2.002 GHz
2 GHz	1 GHz	2 GHz	1.98 GHz		2.02 GHz
3 GHz	1 MHz	3 GHz	2.999 98 GHz		3.000 02 GHz
3 GHz	10 MHz	3 GHz	2.999 7 GHz		3.000 3 GHz
3 GHz	100 MHz	3 GHz	2.998 GHz		3.002 GHz
3 GHz	1 GHz	3 GHz	2.98 GHz		3.02 GHz
6 GHz	1 MHz	6 GHz	5.999 98 GHz		6.000 02 GHz
6 GHz	10 MHz	6 GHz	5.999 8 GHz		6.000 2 GHz
6 GHz	100 MHz	6 GHz	5.998 GHz		6.002 GHz
6 GHz	1 GHz	6 GHz	5.98 GHz		6.02 GHz
9 GHz	1 MHz	9 GHz	8.999 98 GHz		9.000 02 GHz
9 GHz	10 MHz	9 GHz	8.999 8 GHz		9.000 2 GHz
9 GHz	100 MHz	9 GHz	8.998 GHz		9.002 GHz
9 GHz	1 GHz	9 GHz	8.98 GHz		9.02 GHz
9 GHz	10 GHz	9 GHz	8.8 GHz		9.2 GHz
12 GHz	1 MHz	12 GHz	11.999 98 GHz		12.000 02 GHz
12 GHz	10 MHz	12 GHz	11.999 8 GHz		12.000 2 GHz
12 GHz	100 MHz	12 GHz	11.998 GHz		12.002 GHz
12 GHz	1 GHz	12 GHz	11.98 GHz		12.02 GHz
12 GHz	10 GHz	12 GHz	11.8 GHz		12.2 GHz
15 GHz	1 MHz	15 GHz	14.999 98 GHz		15.000 02 GHz
15 GHz	10 MHz	15 GHz	14.999 8 GHz		15.000 2 GHz
15 GHz	100 MHz	15 GHz	14.998 GHz		15.002 GHz
15 GHz	1 GHz	15 GHz	14.98 GHz		15.02 GHz
15 GHz	10 GHz	15 GHz	14.8 GHz		15.2 GHz
18 GHz	1 MHz	18 GHz	17.999 98 GHz		18.000 02 GHz
18 GHz	10 MHz	18 GHz	17.999 8 GHz		18.000 2 GHz
18 GHz	100 MHz	18 GHz	17.998 GHz		18.002 GHz
18 GHz	1 GHz	18 GHz	17.98 GHz		18.02 GHz
18 GHz	10 GHz	18 GHz	17.8 GHz		18.2 GHz

2. Frequency Span Accuracy Test

Related Adjustment Sweep, DAC, and Main Coil Driver Adjustments

Specification For spans $\leq n \times 5$ MHz, $\pm 1\%$ of indicated frequency separation.
 For spans $> n \times 5$ MHz, $\pm 3\%$ of indicated frequency separation.

n*	Center Frequency
1	100 Hz to 5.8 GHz
2	5.8 GHz to 12.5 GHz
3	12.5 GHz to 18.6 GHz
4	>18.6 GHz

* n is the harmonic mixing number, depending on center frequency.

Description Spans less than 100 MHz are checked with a frequency synthesizer by comparing the displayed frequency span of two signals with their known span. Wider spans are tested by tuning a synthesized sweeper from one edge of the analyzer display to the other and measuring the frequency change with a frequency counter.

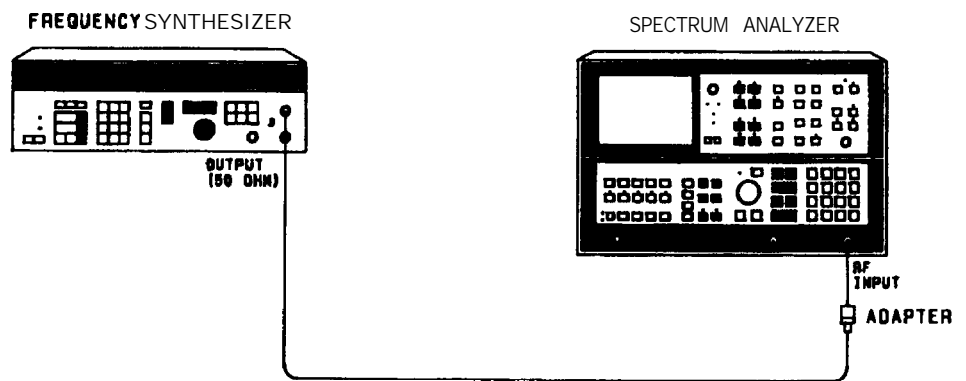

Figure 2-3. Narrow Span Test Setup

Note Equipment listed is for two test setups, Figure 2-3 and Figure 2-4.

2. Frequency Span Accuracy Test

Equipment	Frequency Synthesizer	HP 3335A
	Synthesized Sweeper	HP 8340A
	Adapter, Type N (m) to BNC (f)	1250-0780
	Adapter, Type N (m) to SMA (f)	1250-1250
	Adapter, SMA Female Connectors	1250-1158
	Cable Assembly, SMA Male Connectors	5061-1086

Procedure

1. Press **[2 - 22 GHz]**.
2. Connect equipment as shown in Figure 2-3.
3. Set the frequency synthesizer for an output frequency of 40 MHz and an output power level of -10 dBm.
4. Key in the following analyzer settings:

[CENTER FREQUENCY]	40 MHz
[FREQUENCY SPAN]	20 kHz
5. Set the frequency synthesizer to 39,992,000 Hz. (See Table 2-3.)
6. Press MARKER **[NORMAL]** and **[PEAK SEARCH]**.
7. Press MARKER [a] and set the frequency synthesizer to 40,008,000 Hz. (See Table 2-3.) Press MARKER **[PEAK SEARCH]**.
8. Using the procedure of steps 5, 6, and 7, measure the frequency separation of the indicated signals for each setting in Table 2-3. The MARKER A frequency should be within the limits given in the table.

Table 2-3. Narrow Span Accuracy

Spectrum Analyzer	Frequency Synthesizer		MARKER A Frequency		
	[FREQUENCY SPAN]	Low (Hz)	High (Hz)	Min	Actual
20 kHz	39,992,000	40,008,000	15.84 kHz		16.16 kHz
50 kHz	39,980,000	40,020,000	39.60 kHz		40.40 kHz
150 kHz	39,940,000	40,060,000	118.80 kHz		121.20 kHz
200 kHz	39,920,000	40,080,000	158.4 kHz		161.6 kHz
1 MHz	39,600,000	40,400,000	792.00 kHz		808.00 kHz
2 MHz	39,200,000	40,800,000	1.584 MHz		1.616 MHz
6 MHz	37,600,000	42,400,000	4.656 MHz		4.944 MHz
10 MHz	36,000,000	44,000,000	7.76 MHz		8.240 MHz
50 MHz	20,000,000	60,000,000	38.80 MHz		41.2 MHz

9. Disconnect the frequency synthesizer from the analyzer input. Connect equipment as shown in Figure 2-4.

2. Frequency Span Accuracy Test

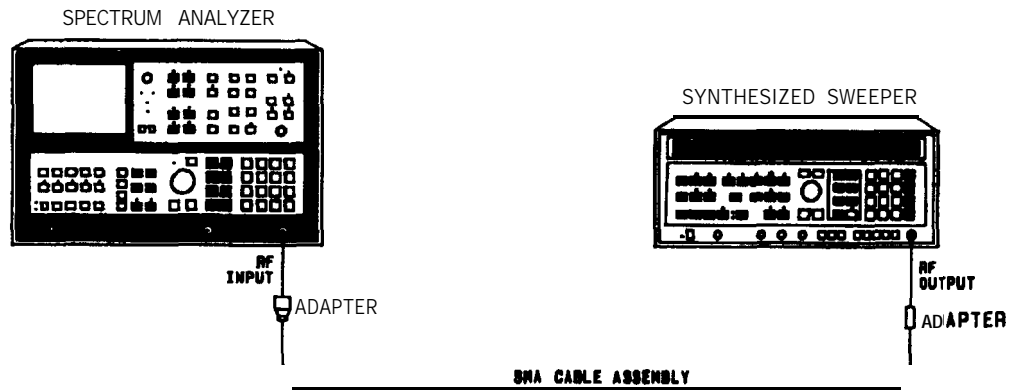

Figure 2-4. Wide Span Test Setup

10. Press **INSTR PRESET** on HP 8340A Synthesized Sweeper.
11. Set the synthesized sweeper to a 4 GHz CW signal and power level of -10 dBm.
12. Press **2 - 22 GHz** on the analyzer.
13. Set spectrum analyzer as follows:

CENTER FREQUENCY	4 GHz
FREQUENCY SPAN50 0 MHz
14. Set the synthesized sweeper to 3.8 MHz. (See Table 2-4.) Press **PEAK SEARCH**.
15. Press **MARKER** **NORMAL** and **PEAK SEARCH**.
16. Press **MARKER A** and set the synthesized sweeper to 4.2 GHz. (See Table 2-4.) Press **PEAK SEARCH**.
17. The **MARKER A** frequency should be between 388 MHz and 412 MHz.
18. Set spectrum analyzer **FREQUENCY SPAN** and **CENTER FREQUENCY** according to Table 2-4 and measure the frequency span by the procedure of steps 13 through 16. The limits for the difference between the two frequency measurements are given in the table.

2. Frequency Span Accuracy Test

Table 2-4. Wide Span Accuracy

Spectrum Analyzer		Synthesized Sweeper		MARKER A Frequency		
CENTER FREQUENCY	FREQUENCY SPAN	Low (GHz)	High (GHz)	Min	Actual	Max
4 GHz	500 MHz	3.800	4.200	388MHz		412 MHz
10 GHz	500 MHz	9.800	10.200	388 MHz		412 MHz
15 GHz	500 MHz	14.800	15.200	388MHz		412 MHz
20 GHz	500 MHz	19.800	20.200	388MHz		412 MHz
4 GHz	1 GHz	3.600	4.400	776MHz		824MHz
10 GHz	1 GHz	9.600	10.400	776MHz		824 MHz
15 GHz	1 GHz	14.600	15.400	776 MHz		824MHz
20 GHz	1 GHz	19.600	20.400	776 MHz		824MHz
10 GHz	5 GHz	8.000	12.000	3.88 GHz		4.12 GHz
15 GHz	5 GHz	13.000	17.000	3.88 GHz		4.12 GHz
18 GHz	5 GHz	16.000	20.000	3.88 GHz		4.12 GHz
10 GHz	10 GHz	6.000	14.000	7.76 GHz		8.24 GHz
15 GHz	10 GHz	11.000	19.000	7.76 GHz		8.24 GHz

3. Resolution Bandwidth Accuracy Test

(For instruments with Option 462, refer to Chapter 4.)

Related Adjustment 3 dB Bandwidth Adjustments

Specification ±20%, 10 Hz to 1 kHz and 3 MHz bandwidths
 ± 10%, 3 kHz to 1 MHz bandwidths
 30 kHz and 100 kHz bandwidth accuracy figures only applicable ≤90% Relative Humidity.

Description The 3 db bandwidth for each resolution bandwidth setting is measured with the MARKER function to determine bandwidth accuracy. The CAL OUTPUT is used for a stable signal source.

Equipment None required

- Procedure**
1. Press **2 - 22 GHz**.
 2. Connect CAL OUTPUT to RF INPUT.
 3. Key in spectrum analyzer settings as follows:

CENTER FREQUENCY	100 MHz
FREQUENCY SPAN	5 MHz
RES BW	3 MHz
REFERENCE LEVEL	-10 dBm
 4. Press SCALE LIN pushbutton. Press (SHIFT, **AUTO**^A (resolution bandwidth) for units in dBm.
 5. Adjust **REFERENCE LEVEL** to position peak of signal trace at (or just below) reference level (top) graticule line. Press SWEEP (**SINGLE**).
 6. Press MARKER (**NORMAL**) and place marker at peak of signal trace with DATA knob. Press MARKER [a] and position movable marker 3 dB down from the stationary marker on the positive-going edge of the signal trace (the MARKER A amplitude readout should be -3.00 dB ±0.05 dB). It may be necessary to press SWEEP (**CONT**) and adjust **CENTER FREQUENCY** to center trace on screen.
 7. Press MARKER (**Δ**) and position movable marker 3 dB down from the signal peak on the negative-going edge of the trace (the MARKER A amplitude readout should be .00 dB f0.05 dB). The 3 dB bandwidth is given by the MARKER A frequency readout. (See Figure 2-5.) Record this value in Table 2-5.

3. Resolution Bandwidth Accuracy Test

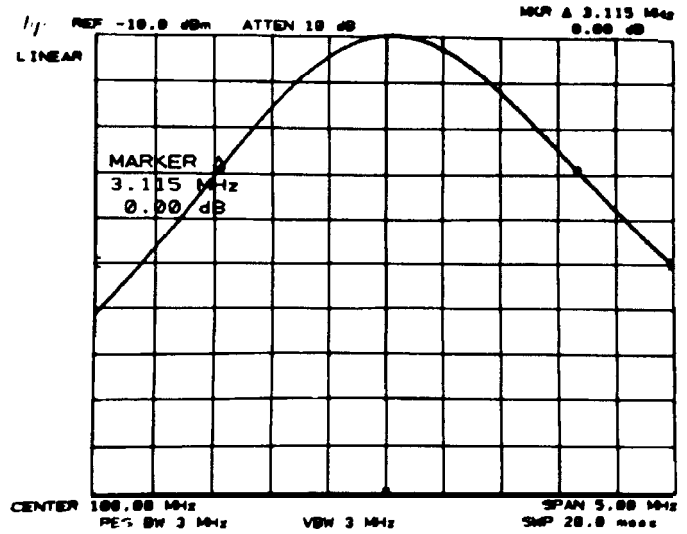

Figure 2-5. Resolution Bandwidth Measurement

8. Vary spectrum analyzer settings according to Table 2-5. Press SWEEP **(SINGLE)** and measure the 3 dB bandwidth for each resolution bandwidth setting by the procedure of steps 6 and 7 and record the value in Table 2-5. The measured bandwidth should fall between the limits shown in the table.

Table 2-5. Bandwidth Accuracy

RES BW	FREQUENCY SPAN	MARKER A Readout of 3 dB Bandwidth		
		Min	Actual	Max
3 MHz	5 MHz	2.400 MHz		3.600 MHz
1 MHz	2 MHz	900 kHz		1.100 MHz
300 kHz	500 kHz	270.0 kHz		330.0 kHz
100 kHz	200 kHz	90.0 kHz		110.0 kHz
30 kHz	50 kHz	27.00 kHz		33.00 kHz
10 kHz	20 kHz	9.00 kHz		11.00 kHz
3 kHz	5 kHz	2.700 kHz		3.300 kHz
1 kHz	2 kHz	800 Hz		1.200 kHz
300 Hz	500 Hz	240 Hz		360 Hz
100 Hz	200 Hz	80 Hz		120 Hz
30 Hz	100 Hz	24.0 Hz		36.0 Hz
10 Hz	100 Hz	8.0 Hz		12.0 Hz

4. Resolution Bandwidth Selectivity Test

(For instruments with Option 462, refer to Chapter 4.)

Related Adjustments

- 3 MHz Bandwidth Filter Adjustments
- 21.4 MHz Bandwidth Filter Adjustments
- Step Gain and 18.4 MHz Local Oscillator Adjustments

Specification

- 60 dB/3 dB bandwidth ratio:
 - <15:1, 3 MHz to 100 kHz bandwidths
 - <13:1, 30 kHz to 10 kHz bandwidths
 - <11:1, 3 kHz to 30 Hz bandwidths
- 60 dB points on 10 Hz bandwidths are separated by <100 Hz

Description

Bandwidth selectivity is found by measuring the 60 dB bandwidth and dividing this value by the 3 dB bandwidth for each resolution bandwidth setting from 30 Hz to 3 MHz. The 60 dB points for the 10 Hz bandwidth setting are also measured. The CAL OUTPUT provides a stable signal for the measurements.

Equipment

None required

Note

Performance Test 3, RESOLUTION BANDWIDTH ACCURACY TEST, must be performed before starting this test.

Procedure

1. Press **2 - 22 GHz**.
2. Connect CAL OUTPUT to RF INPUT.
3. Key in analyzer control settings as follows:

CENTER FREQUENCY	100 MHz
FREQUENCY SPAN	20 MHz
RES BW	3 MHz
VIDEO BW	100 Hz
SWEEP SINGLE	

4. Press MARKER **NORMAL** and position marker at peak of signal trace. Press MARKER **A** and position movable marker 60 dB down from the stationary marker on the positive-going edge of the signal trace (the MARKER A amplitude readout should be -60.00 dB ± 1.00 dB). It may be necessary to press SWEEP **CONT** and adjust **CENTER FREQUENCY** so that both 60 dB points are displayed. (See Figure 2-6.)
5. Press MARKER In] and position movable marker 60 dB down from the signal peak on the negative-going edge of the signal trace (the MARKER A amplitude readout should be .00 dB f0.50 dB).
6. Read the 60 dB bandwidth for the 3 MHz resolution bandwidth setting from the MARKER A frequency readout (Figure 2-6) and record the value in Table 2-6.

4. Resolution Bandwidth Selectivity Test

- Vary spectrum analyzer settings according to Table 2-6. Press SWEEP (SINGLE) and measure the 60 dB bandwidth for each resolution bandwidth setting by the procedure of steps 4 through 6. Record the value in Table 2-6.
- Record the 3 dB bandwidths from Table 2-5 in Table 2-6.
- Calculate the bandwidth selectivity for each setting by dividing the 60 dB bandwidth by the 3 dB bandwidth. The bandwidth ratios should be less than the maximum values shown in Table 2-6.
- The 60 dB bandwidth for the 10 Hz resolution bandwidth setting should be less than 100 Hz.

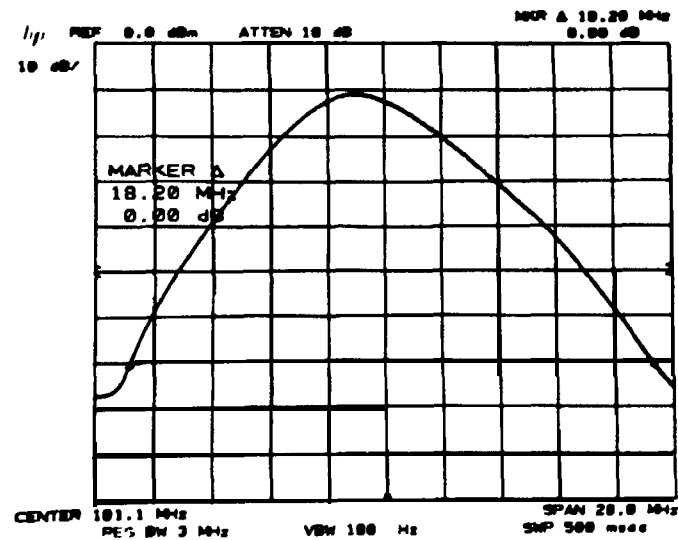

Figure 2-6. 60 dB Bandwidth Measurement

4. Resolution Bandwidth Selectivity Test

Table 2-6. Resolution Bandwidth Selectivity

Spectrum Analyzer			Measured 60 dB Bandwidth	Measured 3 dB Bandwidth	Bandwidth Selectivity (60 dB BW ÷ 3dBBW)	Maximum Selectivity Ratio
RES BW	FREQUENCY SPAN	VIDEO BW				
3 MHz	20 MHz	100 Hz				15:1
1 MHz	15 MHz	300 Hz				15:1
300 kHz	5 MHz	AUTO				15:1
100 kHz	2 MHz	AUTO				15:1
30 kHz	500 kHz	AUTO				13:1
10 kHz	200 kHz	AUTO				13:1
3 kHz	50 kHz	AUTO				11:1
1 kHz	10 kHz	AUTO				11:1
300 Hz	5 kHz	AUTO				11:1
100 Hz	2 kHz	AUTO				11:1
30 Hz	500 Hz	AUTO				11:1
10 Hz	100 HZ	AUTO		60 dB points separated by <100 Hz		

5. Resolution Bandwidth Switching Uncertainty Test

(For instruments with Option 462, refer to Chapter 4.)

Related Adjustments 3 MHz Bandwidth Filter Adjustments
 21.4 MHz Bandwidth Filter Adjustments
 Down/Up Converter Adjustments

Specification (uncorrected; referenced to 1 MHz bandwidth; 20 to 30° C)

	Resolution Bandwidth
±2.0 dB	10 Hz
±0.8 dB	30 Hz
±0.5 dB	100 Hz to 1 MHz
±1.0 dB	3 MHz

Description The CAL OUTPUT signal is applied to the input of the spectrum analyzer. The deviation in peak amplitude of the signal trace is then measured as each resolution bandwidth filter is switched in.

Equipment None required

- Procedure**
- Press **[2 - 22 GHz]**.
 - Connect CAL OUTPUT to RF INPUT.
 - Key in the following control settings:

[CENTER FREQUENCY] 100 MHz
[FREQUENCY SPAN] 5 MHz
[REFERENCE LEVEL] -8 dBm
[RES BW] 1 MHz
 - Press LOG **[ENTER dB/DIV]** and key in 1 dB. Press MARKER **[PEAK SEARCH]**, [al.
 - Key in settings according to Table 2-6. Press MARKER **[PEAK SEARCH]** at each setting, then read the amplitude deviation from the MARKER A readout at the upper right of the display. (See Figure 2-7.) The allowable deviation for each resolution bandwidth setting is shown in the table.

5. Resolution Bandwidth Switching Uncertainty Test

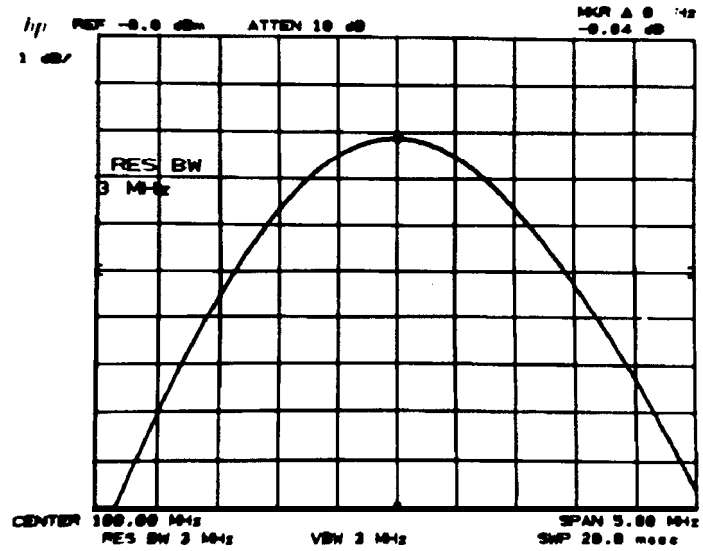

Figure 2-7. Bandwidth Switching Uncertainty Measurement

Table 2-7. Bandwidth Switching Uncertainty

RES BW	FREQUENCY SPAN	ion (MKR A Readout, dB)	Allowable Deviation (dB)
1 MHz	5 MHz	0 (ref)	0 (ref)
3 MHz	5 MHz		f1.00
300 kHz	5 MHz		f0.50
100 kHz	500 kHz		f0.50
30 kHz	500 kHz		f0.50
10 kHz	50 kHz		f0.50
3 kHz	50 kHz		f0.50
1 kHz	10 kHz		f0.50
300 Hz	1 kHz		f0.50
100 Hz	1 kHz		f0.50
30 Hz	200 Hz		±0.80
10 Hz	100 Hz		f2.00

6. Log Scale Switching Uncertainty Test

Related Adjustment	Video Processor Adjustments												
Specification	f0.5 dB (uncorrected; 20° to 30°C)												
Description	The log scale is stepped from 1 dB/DIV to 10 dB/DIV and the variation in trace amplitude from the 1 dB/DIV setting at each step is measured.												
Equipment	None required												
Procedure	<ol style="list-style-type: none"> 1. Press 2 - 22 GHz. 2. Key in analyzer settings as follows: <table border="0" style="margin-left: 20px;"> <tr> <td>CENTER FREQUENCY</td> <td>.....</td> <td>,100 MHz</td> </tr> <tr> <td>FREQUENCY SPAN</td> <td>.....</td> <td>100 kHz</td> </tr> <tr> <td>REFERENCE LEVEL</td> <td>.....</td> <td>-.8 dBm</td> </tr> <tr> <td>RES BW</td> <td>.....</td> <td>.30 kHz</td> </tr> </table> 3. Press LOG ENTER dB/DIV and key in a log scale of 1 dB per division. 4. Connect CAL OUTPUT to RF INPUT. 5. Press MARKER PEAK SEARCH and MKR → REF LVL. Record the marker amplitude (upper right of display) in Table 2-8. 6. Step up through the log scales with ↑. At each step, press MARKER PEAK SEARCH, then record the marker amplitude in Table 2-8. Refer to Figure 2-8. 7. Subtract the marker amplitude at the 1 dB/DIV setting from the marker amplitudes recorded for the 2, 5, and 10 dB/DIV settings to obtain the amplitude deviations. The deviation should be less than f0.5 dB for each log scale. 	CENTER FREQUENCY	,100 MHz	FREQUENCY SPAN	100 kHz	REFERENCE LEVEL	-.8 dBm	RES BW30 kHz
CENTER FREQUENCY	,100 MHz											
FREQUENCY SPAN	100 kHz											
REFERENCE LEVEL	-.8 dBm											
RES BW30 kHz											

6. Log Scale Switching Uncertainty Test

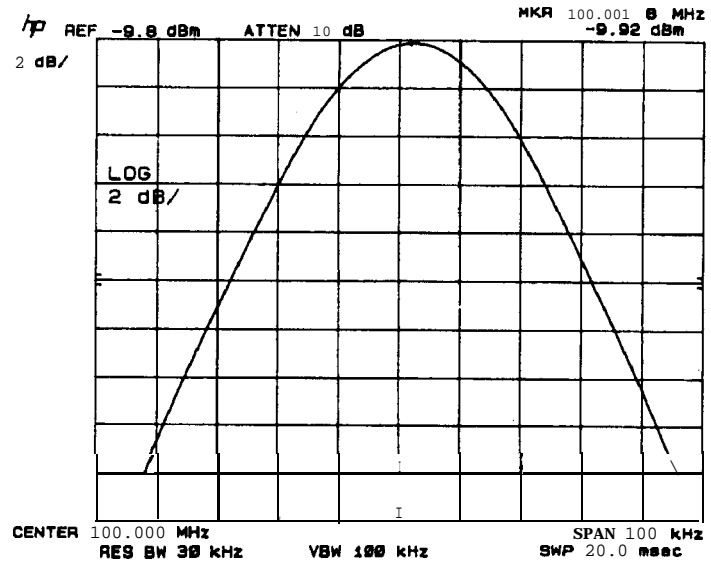

Figure 2-8. Log Scale Switching Uncertainty Measurement

Table 2-8. Log Scale Switching Uncertainty

SCALE (dB/DIV)	MKR Amplitude (dBm)	Deviation (dB)	Allowable Deviation (dB)
1		0 (ref)	0 (ref)
2			f0.5
5			f0.5
10			f0.5

7. IF Gain Uncertainty Test

Related Adjustments Step Gain and 18.4 MHz Local Oscillator Adjustments
21.4 MHz Bandwidth Filter Adjustments

Specification Assuming the internal calibration signal is used to calibrate the reference level at -10 dBm and the input attenuator is fixed at 10 dB, any changes in reference level from the -10 dB setting will contribute to IF gain uncertainty as shown:

Range	Uncertainty (uncorrected; 20 to 30°C)
0 dBm to -55.9 dBm	Res BW \geq 30 Hz, f0.6 dB; Res BW = 10 Hz, f1.6 dB
-56.0 dBm to -129.9 dBm	Res BW \geq 30 Hz, \pm 1.0 dB; Res BW = 10 Hz, f2.0 dB

Description The IF gain steps are tested over the entire range from 0 dBm to -129.9 dBm using an RF substitution method. The 10 dB, 2 dB, and 0.1 dB steps are compared against a calibrated signal source provided by an HP 3335A Frequency Synthesizer.

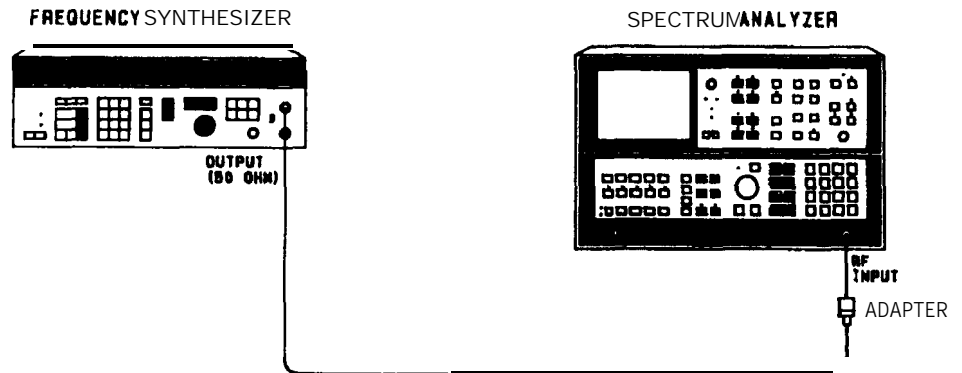

Figure 2-9. IF Gain Uncertainty Test Setup

7. IF Gain Uncertainty Test

Equipment

Frequency SynthesizerHP 3335A
 Adapter, Type N (m) to BNC (f) 1250-0780

Procedure

1. Press **2 - 22 GHz**.
2. Connect CAL OUTPUT to RF INPUT.
3. Press **RECALL** **8**. Adjust AMPTD CAL for a MARKER amplitude of -10.00 dBm f0.02 dB.
4. Press **2 - 22 GHz**.

10 dB Gain Steps

5. Set the frequency synthesizer for an output frequency of 20.0010 MHz and an output power level of -2.0 dBm. Set the amplitude increment for 10 dB steps.
6. Connect the equipment as shown in Figure 2-9.
7. Key in analyzer settings as follows:

CENTER FREQUENCY 20.001 MHz
FREQUENCY SPAN 2 kHz

8. Press **MARKER** **(PEAK SEARCH)**, **(MKR → CF)** or adjust **CENTER FREQUENCY** to center signal trace on display.

9. Set analyzer as follows:

VIDEO BW 100 Hz
RES BW 1 kHz
LOG **(ENTER dB/DIV)** 1 dB

10. Press **MARKER** **(PEAK SEARCH)**, **(Δ)**.
11. Press **(SHIFT)**, **(ATTEN)**¹ to permit extended reference level settings.
12. Set the analyzer **(REFERENCE LEVEL)**, **(VIDEO BW)**, and frequency synthesizer amplitude according to Table 2-9 settings. (Use the frequency synthesizer **(↓)** for 10 dB steps.) At each setting, note the MKR A amplitude displayed in the upper right corner of the analyzer display (deviation from the 0 dB reference setting) and record it in the table. See Figure 2-10.

Note

After measurement at the **(REFERENCE LEVEL)** = -70 dBm setting, press **(SHIFT)**, **(CENTER dB/DIV)**¹ as indicated in Table 2-9.

7. IF Gain Uncertainty Test

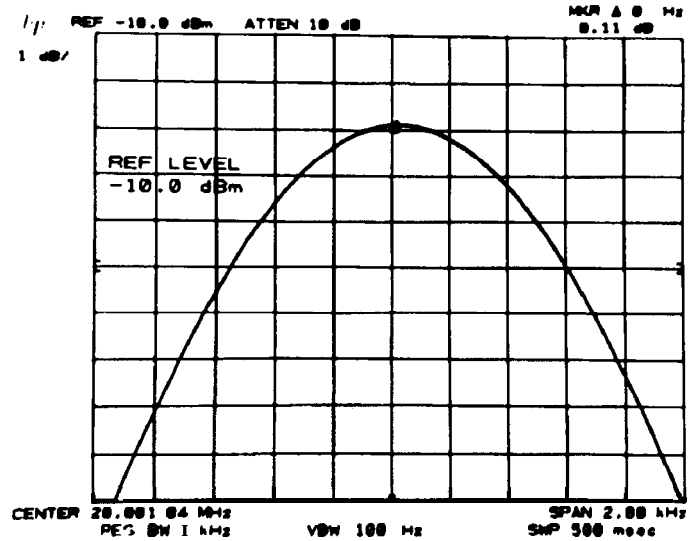

Figure 2-10. IF Gain Uncertainty Measurement

Table 2-9. IF Gain Uncertainty, 10 dB Steps

REFERENCE LEVEL (dBm)	Frequency Synthesizer Amplitude (dBm)	VIDEO BW (Hz)	Deviation (Marker A Amplitude (dB)
0	-2	100	0 (ref.)
-10	-12	100	
-20	-22	100	
-30	-32	100	
-40	-42	100	
-50	-52	100	
-60	-62	10	
-70	-72	10	
SHIFT			
ENTER dB/DIV^a			
-80	-32	100	
-90	-42	100	
-100	-52	10	
-110	-62	10	
-120	-72	10	

7. IF Gain Uncertainty Test

2 dB Gain Steps

13. Press **2 - 22 GHz**, **RECALL** **7**.
14. Set **REFERENCE LEVEL** to -1.9 dBm.
15. Press **MARKER** **OFF**. Set **VIDEO BW** to 100 Hz.
16. Set the frequency synthesizer for an output power level of -3.9 dBm. Set the amplitude increment for 2 dB steps.
17. Press **MARKER** **PEAK SEARCH**, **Δ**.
18. Set the analyzer **REFERENCE LEVEL** and the frequency synthesizer amplitude according to Table 2-10. At each setting, note the MKR A amplitude and record it in the table.

Table 2-10. IF Gain Uncertainty, 2 dB Steps

REFERENCE LEVEL (dBm)	Frequency Synthesizer Amplitude (dBm)	Deviation (MARKER A Amplitude (dB)
-1.9	-3.9	0 (ref)
-3.9	-5.9	
-5.9	-7.9	
-7.9	-9.9	
-9.9	-11.9	

0.1 dB Gain Steps

19. Set **REFERENCE LEVEL** to 0 dB.
20. Set the frequency synthesizer for an output power level of -2.00 dBm. Set the amplitude increment for 0.1 dB steps.
21. Press **MARKER** **PEAK SEARCH**, **Δ**.
22. Set the analyzer **REFERENCE LEVEL** and the frequency synthesizer amplitude according to Table 2-11. At each setting, note the MKR A amplitude and record it in the table.

7. IF Gain Uncertainty Test

Table 2-11. IF Gain Uncertainty, 0.1 dB Steps

(REFERENCE LEVEL) (dBm)	Frequency Synthesizer Amplitude (dBm)	Deviation (MKR A Amplitude (dB)
0.0	-2.00	0 (ref)
-0.1	-2.10	
-0.2	-2.20	
-0.3	-2.30	
-0.4	-2.40	
-0.5	-2.50	
-0.6	-2.60	
-0.7	-2.70	
-0.8	-2.80	
-0.9	-2.90	
-1.0	-3.00	
-1.1	-3.10	
-1.2	-3.20	
-1.3	-3.30	
-1.4	-3.40	
-1.5	-3.50	
-1.6	-3.60	
-1.7	-3.70	
-1.8	-3.80	
-1.9	-3.90	

7. IF Gain Uncertainty Test

23. Find the largest positive deviation and the largest negative deviation for reference level settings from 0 dBm to -70 dBm in Table 2-9. Also, find the largest positive and negative deviations for the last five settings in the table.

	A	B
Reference Level Range:	0 to -70 dBm	-80 to -120 dBm
Largest Positive Deviation:	_____ dB	_____ dB
Largest Negative Deviation:	_____ dB	_____ dB

24. Find the largest positive and negative deviations in Table 2-10 and Table 2-11:

	C Table 10	D Table 11
Largest Positive Deviation:	_____ dB	_____ dB
Largest Negative Deviation:	_____ dB	_____ dB

25. The sum of the positive deviations recorded in A, C, and D should not exceed 0.6 dB.
26. The sum of the negative deviations recorded in A, C, and D should not be less than -0.6 dB.
27. The sum of the positive deviations recorded in A, B, C, and D should not exceed 1.0 dB.
28. The sum of the negative deviations recorded in A, B, C, and D should not exceed - 1 .0 dB.

8. Amplitude Fidelity Test

(For instruments with Option 857, refer to Chapter 5.)

Related Adjustment Log Amplifier Adjustments

Specification Log:
Incremental
f0.1 dB/dB over 0 to 80 dB display
Cumulative
3 MHz to 30 Hz Resolution Bandwidth
 $\leq \pm 1.0$ dB over 0 to 80 dB display (20 to 30°C)
 $\leq \pm 1.5$ dB over 0 to 90 dB display Linear:
 $\pm 3\%$ of Reference Level for top 9 1/2 divisions of display

Description Amplitude fidelity in log and linear modes is tested by decreasing the signal level to the spectrum analyzer in 10 dB steps with a calibrated signal source and measuring the displayed amplitude change with the analyzer's MARKER A function.

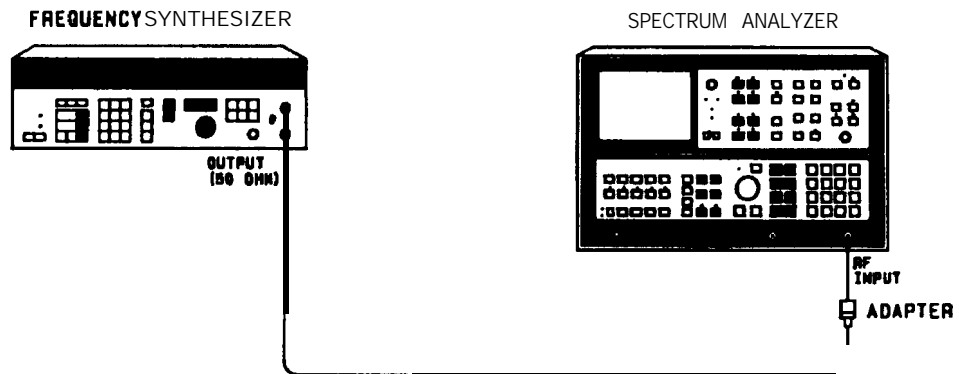

Figure 2-11. Amplitude Fidelity Test Setup

8. Amplitude Fidelity Test

Equipment Frequency Synthesizer HP 3335A
 Adapter, Type N (m) to BNC (f) 1250-0780

Procedure Log Fidelity

1. Set the frequency synthesizer for an output frequency of 20.000 MHz and an output power level of + 10 dBm. Set the amplitude increment for 10 dB steps.
2. Connect equipment as shown in Figure 2-1 1.
3. Press **2 - 22 GHz** on the analyzer. Key in analyzer settings as follows:

CENTER FREQUENCY 20 MHz
FREQUENCY SPAN 50 kHz
REFERENCE LEVEL + 10 dBm

4. Press **MARKER** **[PEAK SEARCH]**, **[MKR → CF]**, **[MKR → REF LVL]** to center the signal on the display.
5. Key in the following analyzer settings:

FREQUENCY SPAN 0 Hz
VIDEO BW 1 Hz

6. Press **MARKER** **[Δ]**. Step the frequency synthesizer output amplitude from + 10 dBm to -80 dBm in 10 dB steps, noting the **MARKER A** amplitude (a negative value) at each step and recording it in column 2 of Table 2-12. Allow several sweeps after each step for the video filtered trace to reach its final amplitude. (See Figure 2-12.)
7. Subtract the value in column 1 from the value in column 2 for each setting to find the fidelity error.
8. Subtract the greatest negative fidelity error from the greatest positive fidelity error for calibrated amplitude steps from -10 dB to -80 dB. The result should be ≤ 1.0 dB

_____ dB

9. Subtract the greatest negative fidelity error from the greatest positive fidelity error for calibrated amplitude steps from -10 dB to -90 dB. The result should be ≤ 1.5 dB

_____ dB

8. Amplitude Fidelity Test

Table 2-12. Log Scale Fidelity

Frequency Synthesizer Amplitude (dBm)	1 Calibrated Amplitude Step (dB)	2 MARKER A Amplitude (dB)	Fidelity Error (Column 2 - Column 1) (dB)
+10	0 (ref)	0 (ref)	0 (ref)
0	-10	_____	_____
-10	-20	_____	_____
-20	-30	_____	_____
-30	-40	_____	_____
-40	-50	_____	_____
-50	-60	_____	_____
-60	-70	_____	_____
-70	-80	_____	_____
-80	-90	_____	_____

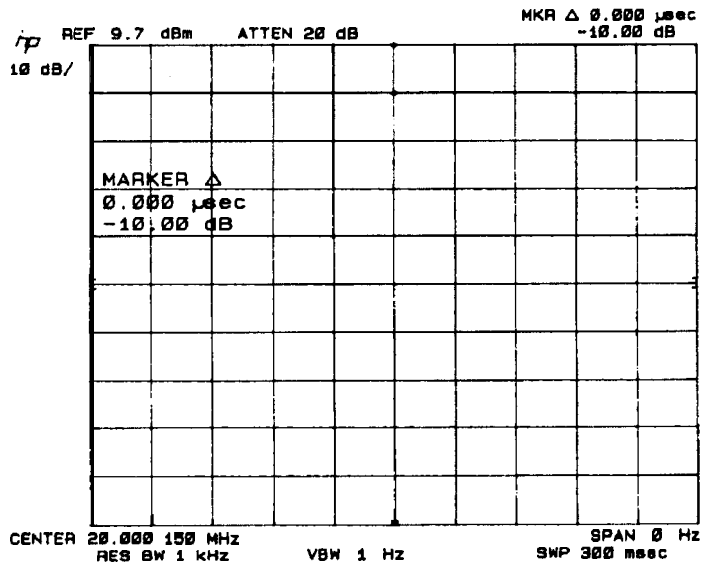

Figure 2-12. Amplitude Fidelity Measurement

8. Amplitude Fidelity Test

Linear Fidelity

10. Key in analyzer settings as follows:

VIDEO BW 300 Hz
FREQUENCY SPAN 1 MHz
RES BW 1 MHz

11. Set the frequency synthesizer for an output power level of + 10 dBm.

12. Press SCALE LIN pushbutton. Press MARKER **(PEAK SEARCH)**, **(MKR → CF)** to center the signal on the display.

13. Set **(FREQUENCY SPAN)** to 0 Hz and **(VIDEO BW)** to 1 Hz. Press (SHIFT), **(AUTO)^A** (resolution bandwidth), MARKER [a].

14. Decrease frequency synthesizer output amplitude by 10 dB steps, noting the MARKER A amplitude and recording it in column 2 of Table 2-13.

Table 2-13. Linear Amplitude Fidelity

Frequency Synthesizer Amplitude (dBm)	MARKER Δ Amplitude (dB)	Allowable Range (±3% of Reference Level) (dB)	
		Min	Max
0	_____	-10.87	-9.21
-10	_____	-23.10	-17.72

9. Calibrator Amplitude Accuracy Test

Related Adjustment CAL OUTPUT Adjustment

Specification -10 dBm f0.3 dB; 100 MHz

Description The output level of the calibrator signal is measured with a power meter.

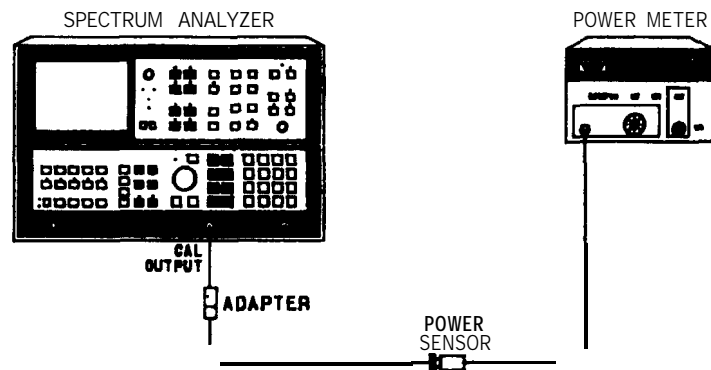

Figure 2-13. Calibrator Amplitude Accuracy Test Setup

Equipment

Power Meter	HP 436A
Power Sensor	HP 8481A
Adapter, Type N (f) to BNC (m)	1250-1477

- Procedure**
1. Connect equipment as shown in Figure 2-13.
 2. Measure output level of the CAL OUTPUT signal. The value should be $-10.0 \text{ dBm} \pm 0.3 \text{ dB}$.

_____dBm

10. Frequency Response Test

Related Adjustments Frequency Response Adjustments

Specifications (Includes input attenuator flatness in the 10 dB setting and mixing mode gain variations, and assumes PRESELECTOR PEAK in current instrument state.)

	Flatness (20 to 30°C)
Tuned Frequency	
100 Hz to 2.5 GHz non-preselected band	±0.6 dB
2 to 12.5 GHz preselected bands	f1.7 dB
12.5 to 18.6 GHz preselected band	f2.2 dB
18.6 to 20 GHz preselected band	f2.2 dB
20 to 22 GHz preselected band	±3.0 dB
Cumulative	
100 Hz to 20 GHz	k2.2 dB
100 Hz to 22 GHz	±3.0 dB
Absolute Amplitude Calibration	f0.6 dB

Description Frequency response is checked across the full range of the spectrum analyzer. In the non-preselected range from 100 Hz to 2.5 GHz, three signal sources are used to make swept measurements: a function generator (100 Hz to 100 kHz), a frequency synthesizer (100 kHz to 60 MHz), and a synthesized sweeper (60 MHz to 2.5 GHz). In the preselected bands from 2 GHz to 22 GHz, a synthesized sweeper is used to check the frequency response. From 100 Hz to 60 MHz, the source flatness permits a direct display of analyzer response. Above 60 MHz, the externally levelled source is first characterized with a power meter. The power sensor Cal Factor % switch is used to compensate for the frequency response of the power meter.

10. Frequency Response Test

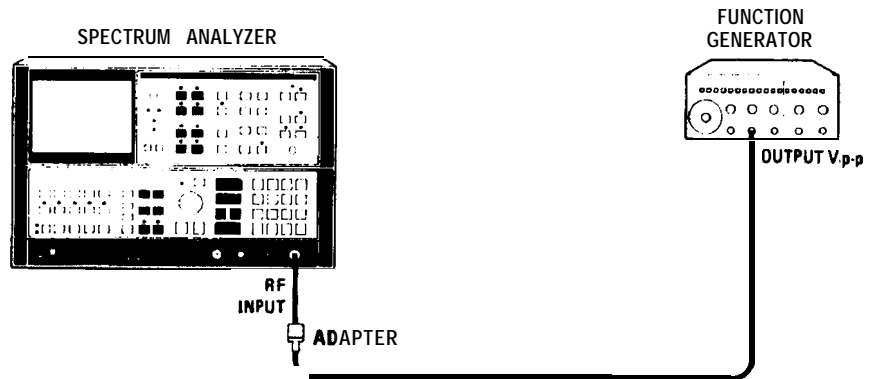

Figure 2-14. Frequency Response Test Setup (100 Hz to 100 kHz)

Note

Equipment listed is for three test setups, Figure 2-14, Figure 2-16, and Figure 2-18.

Equipment

Synthesized Sweeper	HP 8340A/B
Frequency Synthesizer	HP 3335A
Function Generator	HP 3312A
Power Meter	HP 436A
Power Sensor	HP 8485A
Adapter, Type N (m) to APC 3.5 (m)	1250-1743
Adapter, Type N Male Connectors	1250-0778
Adapter, Type N (m) to BNC (f)	1250-0780
Adapter, APC 3.5 (f) to APC 3.5 (f) (two required)	1250-1749
Power Splitter	HP 11667B
Low-loss Microwave Test Cable (APC 3.5)	8120-4921

10. Frequency Response Test

Procedure

100 Hz to 100 kHz

1. Connect CAL OUTPUT to the RF INPUT on the spectrum analyzer.
2. Press **(2 - 22 GHz)**, (RECALL) **(8)**, MARKER **(PEAK SEARCH]**, and adjust AMPTD CAL for a MARKER amplitude of -10.00 dBm f0.02 dB.
3. Press **(2 - 22 GHz)** on the spectrum analyzer. Connect function generator to analyzer RF INPUT as shown in Figure 2-14.
4. Key in analyzer settings as follows:

(START FREQ) kHz
(STOP FREQ) 10 0 kHz

5. Set function generator controls as follows:

RANGE Hz 10 K
FUNCTION ~
OFFSET CAL
AMPLITUDE 1 V
AMPLITUDE VERNIER midrange
SYM CAL
TRIGGER PHASE FREE RUN
MODULATION all out
MODULATION RANGE Hz 1
MODULATION RANGE Hz VERNIER 10 o'clock
MODULATION SYM CAL
Percent Modulation fullycw

6. Adjust function generator FREQUENCY to place generator signal near the center graticule on the analyzer display.
7. Adjust the AMPLITUDE VERNIER on the function generator until the peak of the generator signal is at the reference level line on the analyzer display.
8. Press LOG **(ENTER dB/DIV)** on the analyzer and key in 1 dB per division.
9. Adjust function generator AMPLITUDE VERNIER to place peak of generator signal 2 dB (2 divisions) down from the reference level. Do not readjust AMPLITUDE VERNIER during test.
10. Adjust FREQUENCY on the function generator to position the signal trace at the right edge of the analyzer display.,
11. Press TRACE A **(MAX HOLD)**. Press MODULATION SWP on the function generator. When function generator completes one sweep, press TRACE A (VIEW). Trace should appear as in Figure 2-15.

10. Frequency Response Test

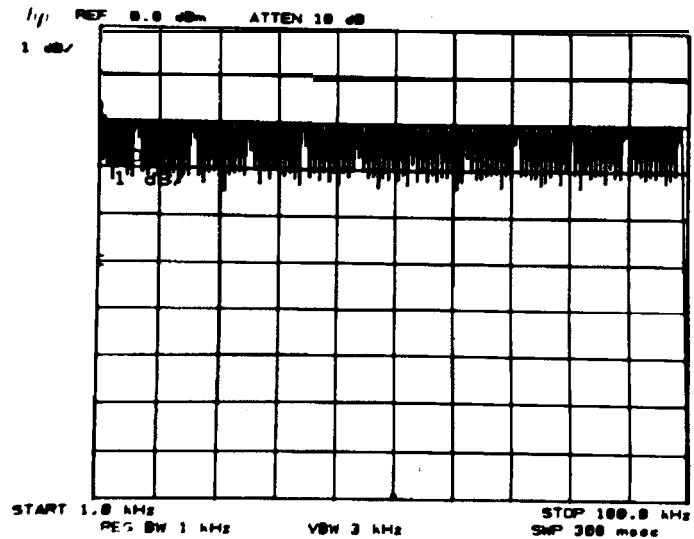

Figure 2-15.
Frequency Response Measurement (1 kHz to 100 kHz)

12. The closely spaced series of signal peaks on the display defines the analyzer response over this frequency range. The maximum and minimum peak amplitudes should not differ by more than 1.2 dB. The MARKER A function may be used to measure this amplitude difference.

Deviation 1 kHz to 100 kHz _____

13. Press **(2 - 22 GHz)** on the analyzer. Key in the following settings:

[CENTER FREQUENCY]	100 HZ
[FREQUENCY SPAN]	100 HZ
14. Press LOG **(ENTER dB/DIV)** and key in 1 dB.
15. Set function generator controls as follows:

RANGE Hz	100
FREQUENCY	1
MODULATION	all out
16. Adjust function generator FREQUENCY to center signal on analyzer display.
17. Press MARKER **(PEAK SEARCH)**. The MKR amplitude should be -2.00 dBm f0.6 dB.

10. Frequency Response Test

18. Set [CF STEP SIZE] to 100 Hz. Step analyzer [CENTER FREQUENCY] from 100 Hz to 1 kHz with [↑] and set function generator FREQUENCY to center signal on display at each step. Press MARKER [PEAK SEARCH] at each frequency. The MKR amplitude should be -2 dBm f0.6 dB.

Deviation 100 Hz to 1 kHz _____

100 kHz to 4 MHz

19. Connect equipment as shown in Figure 2-16.

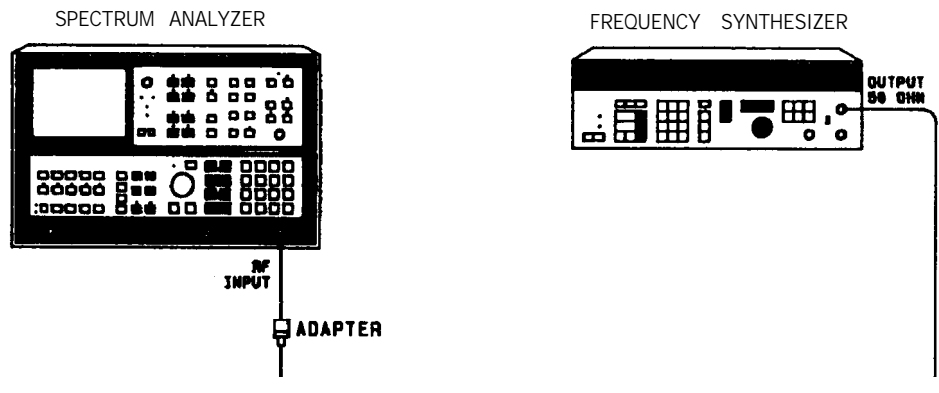

Figure 2-16.
Frequency Response Test Setup (100 kHz to 60 MHz)

20. Press [0 - 2.5 GHz] on the analyzer. Key in the following settings:
- | | |
|---------------------------------|--------|
| <u>[CENTER FREQUENCY]</u> | .4 MHz |
| <u>[FREQUENCY SPAN]</u> | .2 MHz |
| <u>CENTER dB/DIV</u> | 1 dB |
21. Set the controls of the frequency synthesizer as follows:
- | | |
|-----------------|--------|
| FREQUENCY | .4 MHz |
| AMPLITUDE | -2 dBm |
22. Adjust the output amplitude of the frequency synthesizer to place the signal at the 8th graticule line.
23. Key in the analyzer settings as follows:
- | | |
|---------------------------|--------|
| <u>[STOP FREQ]</u> | .4 MHz |
| <u>[START FREQ]</u> | .0 Hz |
24. Key in the frequency synthesizer settings as follows:
- | | |
|-------------------|--------------|
| FREQUENCY | 2,000,100 Hz |
| SWEEP WIDTH | 3,998,000 Hz |
25. Press TRACE A [CLEAR-WRITE] and [MAX] on the analyzer.

10. Frequency Response Test

26. Press START SINGLE 50 SEC SWEEP on the frequency synthesizer. Wait for completion of the sweep.
27. Activate MARKER **(NORMAL)** on the analyzer. Determine minimum and maximum amplitude points by using DATA knob to position the marker. Record the amplitude and frequency for each of the minimum and maximum points in Table 2-14.

Note

Disregard any response ≤ 100 kHz.

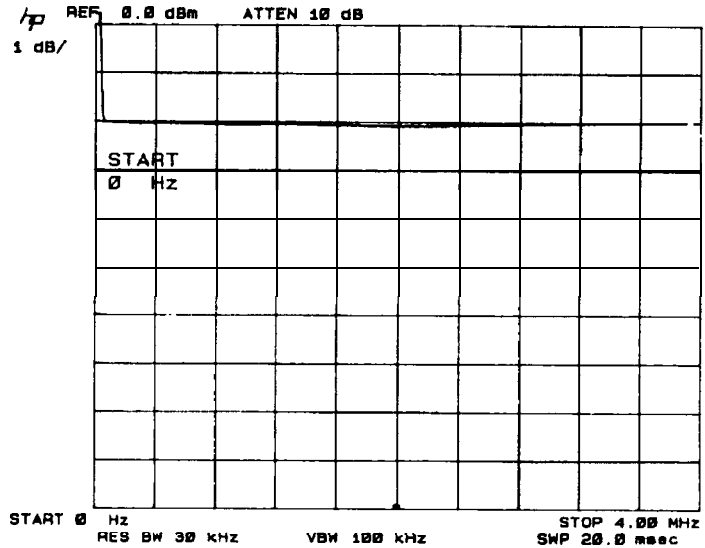

Figure 2-17.
Frequency Response Measurement (100 kHz to 4 MHz)

Table 2-14. 100 Hz to 2.5 GHz Frequency Rand

Spectrum Analyzer		Frequency Synthesizer		Synthesized Sweeper		Trace Limits			
				Sweep Time 150 s		Spec f0.6 dB			
START FREQ	STOP FREQ	Freq	Sweep Width	START FREQ	STOP FREQ	Minimum		Maximum	
						Amp	Freq	Amp	Freq
100 Hz	4 MHz	2,000,100 Hz	3,998,000 Hz						
4 MHz	60 MHz	30050 kHz	59900 kHz						
60 MHz	2.5 GHz			60 MHz	2.5 GHz				

10. Frequency Response Test

4 MHz to 60 MHz

28. Press **0 - 2.5 GHz** on the spectrum analyzer. Set the spectrum analyzer controls as follows:

CENTER FREQUENCY 4 MHz
FREQUENCY SPAN 4 MHz
RES BW 300 kHz
ENTER dB/DIV dB

29. Set the frequency of the frequency synthesizer to 4 MHz.
 30. Adjust the output amplitude of the frequency synthesizer to place the signal at the 8th graticule line.
 31. Key in the analyzer settings as follows:

START FREQ 100 kHz
STOP FREQ 60 MHz

32. Key in the frequency synthesizer settings as follows:

FREQUENCY 30,050,000 Hz
 SWEEP WIDTH 59,900,000 Hz

33. Press TRACE A **(CLEAR-WRITE)** and **(MAX HOLD)** on the analyzer.

34. Press START SINGLE 50 SEC SWEEP on the frequency synthesizer. Wait for completion of the sweep.

35. Activate MARKER **(NORMAL)** on the analyzer. Determine minimum and maximum amplitude points by using the DATA knob to position the marker. Record the amplitude and frequency for each of the minimum and maximum points in Table 2-14.

Note

Disregard any response below 4 MHz.

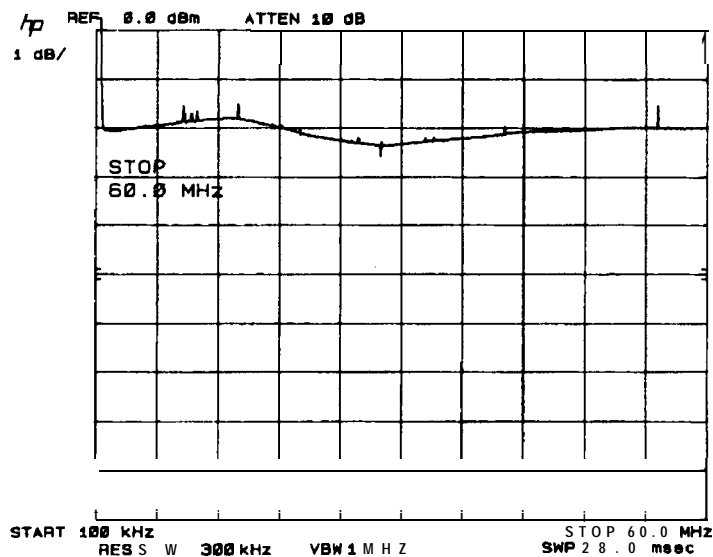

Figure 2-18.
Frequency Response Measurement (4 MHz to 60 MHz)

10. Frequency Response Test

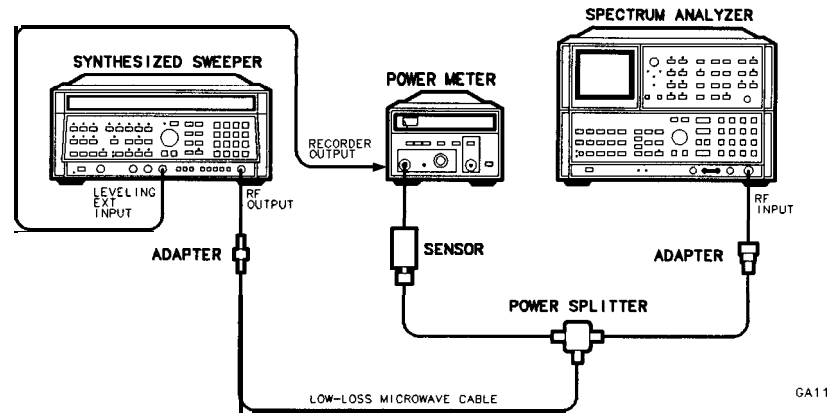

Figure 2-19.
Frequency Response Test Setup (60 MHz to 2.5 GHz, 2 to 22 GHz)

60 MHz to 2.5 GHz

36. Connect equipment as shown in Figure 2-19, with one resistive output of the power splitter connected to the power meter/power sensor, and the second resistive output connected to the spectrum analyzer RF INPUT using an APC 3.5 (m) to Type N (m) adapter. Connect the power meter rear panel RECORDER OUTPUT to the synthesized sweeper front panel LEVELING EXT INPUT.
37. On the power meter, verify that the RANGE HOLD switch is off.
Consult the power sensor Cal Factor versus Frequency graph or table and set the power meter CAL FACTOR % switch to the 100 MHz calibration setting.
38. Press INSTR PRESET on the synthesized sweeper. Set the controls of the synthesized sweeper as follows:

CW	100 MHz
POWER LEVEL	-9.0 dBm
RF	on
LEVELING	INT
39. On the synthesized sweeper, press POWER LEVEL and adjust the ENTRY knob for a power meter indication of -15.00 dBm f0.10 dB at 100 MHz.
40. On the power meter, press RANGE HOLD (turning it on).
41. On the synthesized sweeper, press POWER LEVEL and adjust the ENTRY knob for a power meter indication of -10.00 ±0.03 dB at 100 MHz.
42. On the synthesized sweeper, press METER leveling and adjust the ENTRY knob (REF in dBV with ATN: 0 dB) for a power meter indication of -10.00 dBm ±0.03 dB at 100 MHz.

Note

Do not vary the synthesized sweeper POWER LEVEL setting (internal leveling) or METER REF and METER ATN settings (external power meter leveling) for the remaining steps in this test procedure.

10. Frequency Response Test

Note

Provide the spectrum analyzer with a 60 MHz to 2.5 GHz input signal of sufficient flatness for measuring frequency response and absolute amplitude accuracy, the synthesized sweeper must be externally leveled with a power meter, using a relatively slow sweep time (at least 40 seconds).

43. On the spectrum analyzer, key in **2-2.5 GHz**, **SHIFT** TRACE A **MAX HOLD** (Ksb). Set the spectrum analyzer controls as follows:

CENTER FREQUENCY	100 MHz
FREQUENCY SPAN	5 MHz
RES BW	3 MHz
VIDEO BW	3 MHz
LOG SCALE	1 dB/DIV
REFERENCE LEVEL	-7 dBm
44. On the spectrum analyzer, press **MARKER** **PEAK SEARCH** and adjust the front-panel **AMPTD CAL** control for a **MARKER** indication of -10.00 dBm \pm 0.01 dB.
45. On the synthesized sweeper, key in **START FREQ** 60 MHz, **STOP FREQ** 2.5 GHz, **SWEEP TIME** 150 s, **SWEEP** **SINGLE**, **SWEEP** **SINGLE**.
46. On the spectrum analyzer, key in **START FREQ** 60 MHz, **STOP FREQ** 2.5 GHz, TRACE B **CLEAR-WRITE**, TRACE B **MAX HOLD**.
47. On the synthesized sweeper, press **SWEEP** **SINGLE** and wait for a sweep to complete (150 seconds) and the **SWEEP LED** to turn off. As the synthesized sweeper tunes from 60 MHz to 2.5 GHz, the spectrum analyzer frequency response is displayed as TRACE B (TRACE A displays the current input signal). When the sweep has completed, the display should appear as shown in Figure 2-20.

10. Frequency Response Test

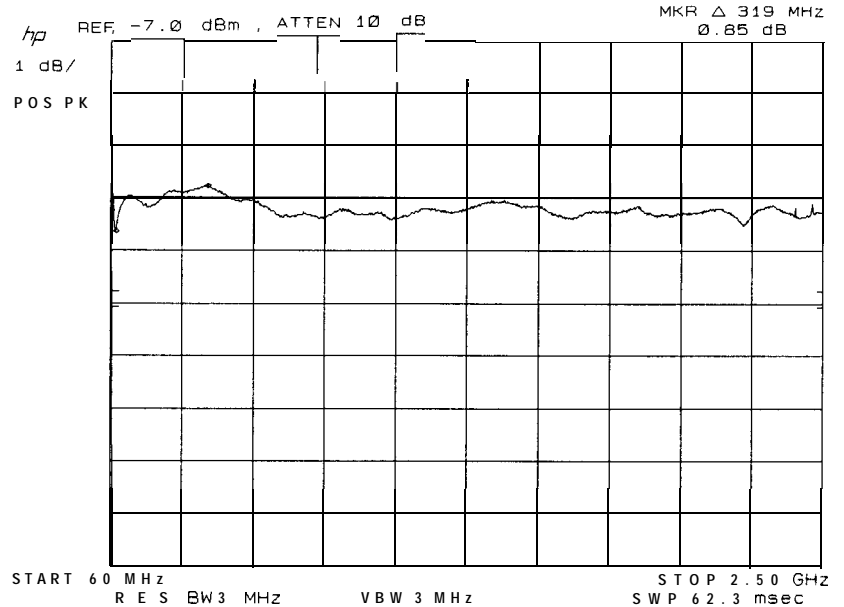

Figure 2-20.
Frequency Response Measurement (60 MHz to 2.5 GHz)

48. On the spectrum analyzer, key in TRACE B **VIEW**, TRACE A **BLANK**, MARKER **NORMAL** and use the DATA knob to position a marker on the highest point on the TRACE B waveform. Record the amplitude and frequency for this maximum point in Table 2-14. The maximum absolute amplitude should be less than -8.80 dBm.
49. On the spectrum analyzer, use the DATA knob to position a marker on the lowest point on the TRACE B waveform. Record the amplitude and frequency for this minimum point in Table 2-14. The minimum absolute amplitude should be greater than - 11.20 dBm.
50. On the spectrum analyzer, press MARKER [a] and use the DATA knob to position a second marker on the highest point on the TRACE B waveform. Flatness (total peak-to-peak amplitude deviation) of the displayed trace should be less than 1.20 dB.

2 to 22 GHz (Preselected Range)

51. On the spectrum analyzer, key in **2-22 GHz**, [SHIFT] **PRESEL PEAK** (KS=), **SHIFT** TRACE A **MAX HOLD** (KSb). Set the spectrum analyzer controls as follows:

START FREQ	2.0 GHz
STOP FREQ	3.9 GHz
RES BW	3 MHz
VIDEO BW	3 MHz
REFERENCE LEVEL	-7 dBm
LOG SCALE	1 dB/DIV
52. Consult the power sensor Cal Factor versus Frequency graph or table and set the power meter CAL FACTOR % switch to the 3 GHz calibration setting.

10. Frequency Response Test

53. On the synthesized sweeper, key in **CW** 3.0 GHz, **START FREQ** 2.0 GHz, **STOP FREQ** 3.9 GHz, **SWEEP TIME** 150 s, SWEEP **SINGLE**, SWEEP **SINGLE**.
54. On the spectrum analyzer, key in TRACE B **CLEAR-WRITE**, TRACE B **MAX HOLD**, (SHIFT) **GHz** (KS/).
55. On the synthesized sweeper, key in **START FREQ**, SWEEP **SINGLE** and wait for a sweep to complete (150 seconds) and the SWEEP LED to turn off. As the synthesized sweeper tunes from 2.0 GHz to 3.9 GHz, the spectrum analyzer frequency response is displayed as TRACE B (TRACE A displays the current input signal).
56. On the synthesized sweeper, press **CW** and use the ENTRY knob to position the peak of the displayed TRACE A signal at the lowest point on the TRACE B waveform.
57. On the spectrum analyzer, key in **PRESEL PEAK** and wait for the PEAKING! message to clear from the CRT.
58. Repeat steps 55 through 57 until the level of the lowest point on the TRACE B waveform does not change.
59. On the spectrum analyzer, key in TRACE B (VIEW), TRACE A **BLANK**, MARKER **NORMAL** and use the DATA knob to position a marker on the highest point on the TRACE B waveform. Record the amplitude and frequency for this maximum point in Column 4 of Table 2-15. The maximum absolute amplitude should be less than -7.70 dBm.
60. On the spectrum analyzer, use the DATA knob to position a marker on the lowest point on the TRACE B waveform. Record the amplitude and frequency for this minimum point in Column 4 of Table 2-15. The minimum absolute amplitude should be greater than -12.30 dBm.
61. On the spectrum analyzer, press MARKER [al, and use the DATA knob to position a second marker on the highest point on the TRACE B waveform. Flatness (total peak-to-peak amplitude deviation) of the displayed trace should be less than 3.40 dB.
62. Set the spectrum analyzer controls as follows:
START FREQ 3.9 GHz
STOP FREQ 5.8 GHz
63. Consult the power sensor Cal Factor versus Frequency graph or table and set the power meter CAL FACTOR % switch to the 5 GHz calibration setting.
64. On the synthesized sweeper, key in **CW** 5.0 GHz, **START FREQ** 3.9 GHz, **STOP FREQ** 5.8 GHz.
65. On the spectrum analyzer, key in TRACE A **CLEAR-WRITE**, TRACE B **CLEAR-WRITE**, TRACE B **MAX HOLD**, (SHIFT) **GHz** (KS/).
66. On the synthesized sweeper, key in **START FREQ**, SWEEP **SINGLE** and wait for a sweep to complete (150 seconds) and the SWEEP LED to turn off. As the synthesized sweeper tunes from 3.9 GHz to 5.8 GHz, the input signal is displayed as a TRACE A response, and the spectrum analyzer frequency response is displayed as TRACE B.

10. Frequency Response Test

67. On the synthesized sweeper, press **(CW)** and use the ENTRY knob to position the peak of the displayed TRACE A signal at the lowest point on the TRACE B waveform.
68. On the spectrum analyzer, key in **(PRESEL PEAK)** and wait for the PEAKING! message to clear from the CRT.
69. Repeat steps 66 through 68 until the level of the lowest point on the TRACE B waveform does not change.
70. On the spectrum analyzer, key in TRACE B (VIEW], TRACE A **(BLANK)**, MARKER **(NORMAL)** and use the DATA knob to position a marker on the highest point on the TRACE B waveform. Record the amplitude and frequency for this maximum point in Column 4 of Table 2-15. The maximum absolute amplitude should be less than -7.70 dBm.
71. On the spectrum analyzer, use the DATA knob to position a marker on the lowest point on the TRACE B waveform. Record the amplitude and frequency for this minimum point in Column 4 of Table 2-15. The minimum absolute amplitude should be greater than -12.30 dBm.
72. On the spectrum analyzer, press MARKER **(Δ)**, and use the DATA knob to position a second marker on the highest point on the TRACE B waveform. Flatness (total peak-to-peak amplitude deviation) of the displayed trace should be less than 3.40 dB.
73. Repeat steps 62 through 72 for the six remaining frequency ranges listed in Table 2-15, setting both the power meter CAL FACTOR % switch and the synthesized sweeper **(CW)** frequency for the power sensor Cal Frequency listed in Column 3.
74. For each frequency band tested, calculate the overall flatness by subtracting the maximum amplitude value from the minimum amplitude value recorded in Column 4 of Table 2-15. Record the result for each frequency band in Column 5 of Table 2-15. Flatness (total peak-to-peak amplitude deviation) for each frequency band should be less than the specified values listed in Column 5 of Table 2-15.
75. Calculate the cumulative flatness for both the 100 Hz to 20 GHz and the 100 Hz to 22 GHz frequency ranges by subtracting the appropriate maximum amplitude value from the appropriate minimum amplitude value recorded in either Table 2-14 or Column 4 of Table 2-15. Record the result for both frequency ranges at the bottom of Table 2-15.

External Mixer Bands (18.6 GHz to 325 GHz)

76. Connect the low-loss microwave test cable to the synthesized sweeper RF OUTPUT using an APC 3.5 (f) to APC 3.5 (f) adapter. Connect the power meter/power sensor to the opposite end of the test cable using an APC 3.5 (f) to APC 3.5 (f) adapter.
77. Press **(INSTR PRESET)** on the synthesized sweeper. Set the controls of the synthesized sweeper as follows:

CW321.4 MHz
POWER LEVEL	-20.0 dBm
RF	on

10. Frequency Response Test

LEVELING INT

78. On the synthesized sweeper, press **POWER LEVEL** and adjust the ENTRY knob for a power meter indication of **-20.00 dBm f0.03 dB** at 321.4 MHz (with the power meter RANGE HOLD switch off).
79. On the synthesized sweeper, key in **POWER LEVEL** **↓** to decrease the output power by **10.0 dB** to **-30 dBm**.
80. Disconnect the jumper cable from between the spectrum analyzer front panel 321.4 MHz IF INPUT and IF OUTPUT connectors.
81. Disconnect the low-loss microwave test cable from the power meter/power sensor, and connect the test cable to the spectrum analyzer front panel 321.4 MHz IF INPUT connector.
82. On the spectrum analyzer, key in **2-22 GHz**, **SHIFT** **↑** (KSU), **6 Hz**, **SHIFT** **REFERENCE LEVEL** (KSZ) **0 dB**, setting the K-band conversion loss to **30 dB**. Set the spectrum analyzer controls as follows:

RES BW	1 MHz
REFERENCE LEVEL	+ 3 dBm
LOG SCALE	1 dB/DIV
83. On the spectrum analyzer, press MARKER **NORMAL**. The MARKER indication should be **0.00 dBm f1.00 dB**. Subtract **0.00 dBm** from the MARKER amplitude, and record the result.

321.4 MHz IF INPUT Sensitivity _____ dB
84. Disconnect the low-loss microwave test cable from the spectrum analyzer front panel 321.4 MHz IF INPUT connector. Reconnect the jumper cable between the spectrum analyzer front panel 321.4 MHz IF INPUT and IF OUTPUT connectors.
85. On the spectrum analyzer, key in **SHIFT** **↑** (KSU), **6 Hz**, **SHIFT** **REFERENCE LEVEL** (KSZ) **-12 dBm**, setting the K-band conversion loss to **18 dBm** (default value).

10. Frequency Response Test

Table 2-15. Frequency Response (Flatness)

1 Frequency Band	2 Spectrum Analyzer and Synthesized Sweeper		3 Center Frequency Power Sensor	4 Trace Limits				5 Flatness (dB)
				Minimum		Maximum		
	START FREQ	STOP FREQ		Amplitude (dBm)	Frequency	Amplitude (dBm)	Frequency	
10 MHz - 2.5 GHz Spec	60 MHz	2.5 GHz	100 MHz	-11.20		-8.80		1.20
2 - 5.8 GHz Spec	2 GHz	3.9 GHz	3 GHz					
	3.9 GHz	5.8 GHz	5 GHz	-12.30		-7.70		3.40
5.8 - 12.5 GHz Spec	5.8 GHz	9.15 GHz	7 GHz					
	9.15 GHz	12.5 GHz	11 GHz	-12.30		-7.70		3.40
12.5 - 18.6 GHz Spec	12.5 GHz	15.55 GHz	14 GHz					
	15.55 GHz	18.6 GHz	17 GHz	-12.80		-7.20		4.40
18.6 - 20 GHz Spec	18.6 GHz	20 GHz	19 GHz	-12.80		-7.20		4.40
20 - 22 GHz Spec	20 GHz	22 GHz	21 GHz	-13.60		-6.40		6.00
Cumulative Flatness (dB)								
100 Hz to 20 GHz Specification: 4.40 dB								
100 Hz to 22 GHz Specification: 6.00 dB								

11. Sweep Time Accuracy Test

Related Adjustment Sweep, DAC, and Main Coil Driver Adjustment

Specification For sweep times ≤ 200 seconds, $\pm 10\%$
 For sweep times > 200 seconds, $\pm 30\%$

Description A universal counter is connected to the PENLIFT RECORDER OUTPUT (on the rear panel) of the 8566B. The counter is used in time interval mode to determine the “pen down” interval of the PENLIFT RECORDER OUTPUT. The penlift output voltage level corresponds directly to the sweeping of the analyzer (pen down = 0V) and not-sweeping of the analyzer (pen up = 15V). A DVM is used to set the appropriate trigger level of the counter.

This test is for sweep times ≥ 20 ms. For faster sweep times, refer to Test 21, Fast Sweep Time Accuracy Test.

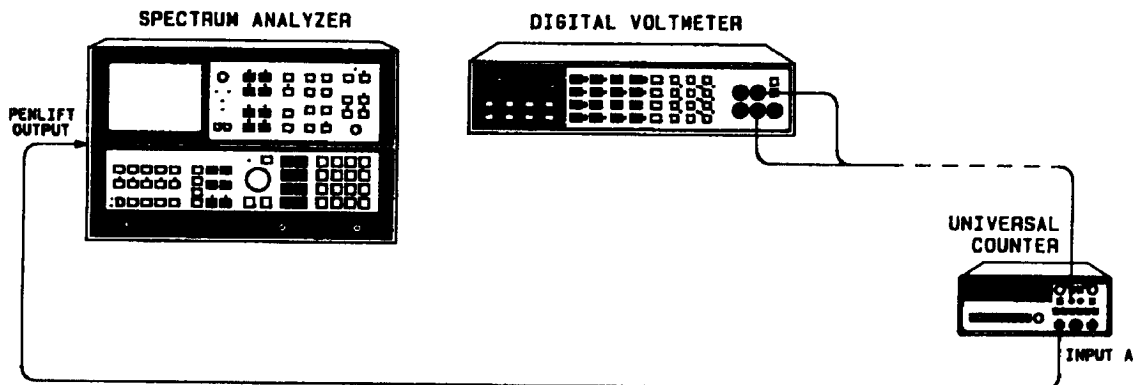

Figure 2-21. Sweep Time Accuracy Test Setup

Equipment	Universal Counter	HP 5316A
	Voltmeter	HP 3456A

11. Sweep Time Accuracy Test

Procedure

1. Connect equipment as shown in Figure 2-21.
2. Press **2 - 22 GHz** SWEEP **SINGLE** on the analyzer.
3. Key in the following settings:

CENTER FREQUENCY	500 MHz
FREQUENCY SPAN	0 Hz
4. Set up the universal counter as follows:
 - a. Set all front panel keys in “out” position.
 - b. Set POWER switch to ON.
 - c. Set GATE TIME vernier control to 9 o'clock.
 - d. Set SEP/COM A switch to COM A position.
 - e. Depress T.I. A → B switch (making sure the blue shift key is out).
 - f. Set Channel A trigger level to trigger on negative slope.
 - g. Set Channel B trigger level to trigger on positive slope.
 - h. Set both Channel A and Channel B ac/dc switches to dc.
 - i. Connect the digital voltmeter to Channel A TRIGGER LEVEL OUT. (Be sure to ground the DVM properly.)
 - j. Adjust Channel A trigger level to set a DVM voltage reading of 0.3 v.
 - k. Repeat steps i and j for Channel B.
5. Set analyzer **SWEEP TIME** to 20 ms. Reset the universal counter and press SWEEP **SINGLE** on the spectrum analyzer.
6. Note the measured sweep time on the universal counter and record this value in **Table 2-16**. The measured sweep time should be a value between the minimum and maximum values given in **Table 2-16**.
7. Repeat steps 5 and 6 for each sweep time setting in **Table 2-16**.

11. Sweep Time Accuracy Test

Table 2-16.
Sweep Time Accuracy, Sweep Times ≥ 20 ms

[SWEEP TIME]	Sweep Time		
	Min	Measured	Max
20 ms	18 ms		22 ms
30 ms	27 ms		33 ms
50 ms	45 ms		55 ms
70 ms	63 ms		77 ms
90 ms	81 ms		99 ms
110 ms	99 ms		121 ms
170 ms	153 ms		187 ms
200 ms	180 ms		220 ms
2 s	1.8 s		2.2 s

8. Press MARKER **[NORMAL]**.
9. Use **[↓]** to place the marker at the second vertical graticule.
10. Press **(SHIFT)**, **[SINGLE]**^u.
11. Set analyzer **[SWEEP TIME]** to 20 s. Allow the universal counter enough time to settle at this sweep time.
12. Note the measured sweep time on the universal counter and record this value in Table 2-17. The measured sweep time should be a **value** between the minimum and maximum values given in **Table 17**.
13. Repeat steps 11 and 12 for 200 s and 240 s sweep times.

Table 2-17. Sweep Time Accuracy

[SWEEP TIME]	MARKER A Time		
	Min	Measured	Max
20 s	3.6 s		4.4 s
200 s	36 ms		44 ms
240 s	33.6 ms		62.4 ms

12. Noise Sidebands Test

Related Adjustments 100 MHz Voltage-Controlled Crystal Oscillator Adjustments
Sweep, DAC, and Main Coil Driver Adjustments
M/N Loop Adjustments
RF Module Phase Lock Adjustments
YTO Loop Adjustments
20/30 Phase Lock Adjustments

Specification For Frequency Span ≤ 25 kHz (except 100 kHz offset) and Center Frequencies from 100 Hz to 5.8 GHz:

Offset from Carrier	Sideband Level (dBc/Hz)
320 Hz	-80
1 kHz	-85
10 kHz	-90
100 kHz	-105

Description A 5.7 GHz signal with low phase noise is input to the spectrum analyzer. The signal and noise sidebands are displayed on the analyzer and the trace is video-averaged. The displayed noise sideband level at various frequency offsets is measured and the measured values are corrected for log amplification and detection errors, then normalized to a 1 Hz bandwidth. A second HP 8566A/B Spectrum Analyzer is used as the signal source for this test. Therefore, if the measured values are not within specification limits, either analyzer may be at fault.

12. Noise Sidebands Test

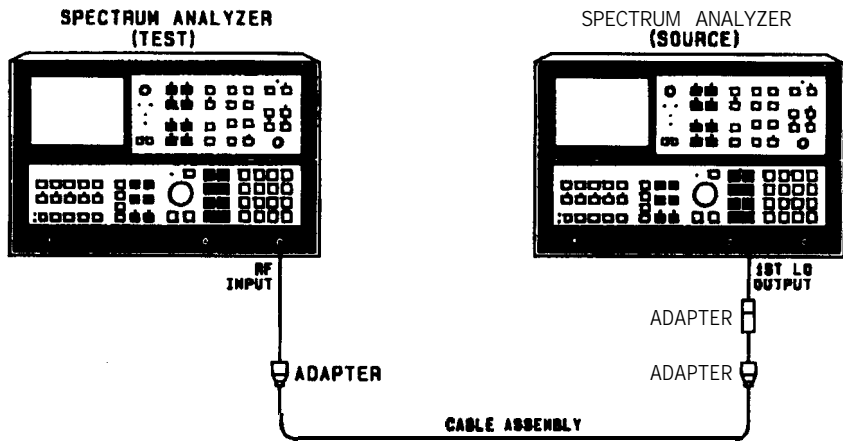

Figure 2-22. Noise Sidebands Test Setup

Equipment	Spectrum Analyzer (1ST LO OUTPUT)	HP 8566A/B
	Adapter, Type N (m) to SMA (f) (2 required)	1250-1250
	Adapter, Type N (f) to BNC (m)	1250-0077
	Cable Assembly, SMA Male Connectors	5061-1086

- Procedure**
1. Allow both analyzers to warm up for at least one-half hour with LINE switch in either the STANDBY or ON position.
 2. On one of the analyzers, connect the CAL OUTPUT to the RF INPUT. Press **(2 - 22 GHz)** then **(RECALL) (9)** and adjust FREQ ZERO control for maximum signal amplitude. Repeat this frequency calibration on the other analyzer. When completed, press **(2 - 22 GHz)** again on each of the analyzers.
 3. Connect 1ST LO OUTPUT of source analyzer to RF INPUT of analyzer under test as shown in Figure 2-22.

Note Do not connect the frequency reference (on the rear panel) of the analyzers to a common frequency reference.

4. Key in the following on the source analyzer:

(CENTER FREQUENCY) 5.7 GHz
(FREQUENCY SPAN) 0 Hz
SHIFT MKR → REF LVL^R (Display diagnostics for convenience)
[SHIFT] (RES BW)^F (YTO Pretest Mode)
SWEEP (SINGLE)

The first line of the diagnostic display and the CENTER readout should both now indicate 5.700 000 000 GHz. This is the 1ST LO OUTPUT frequency.

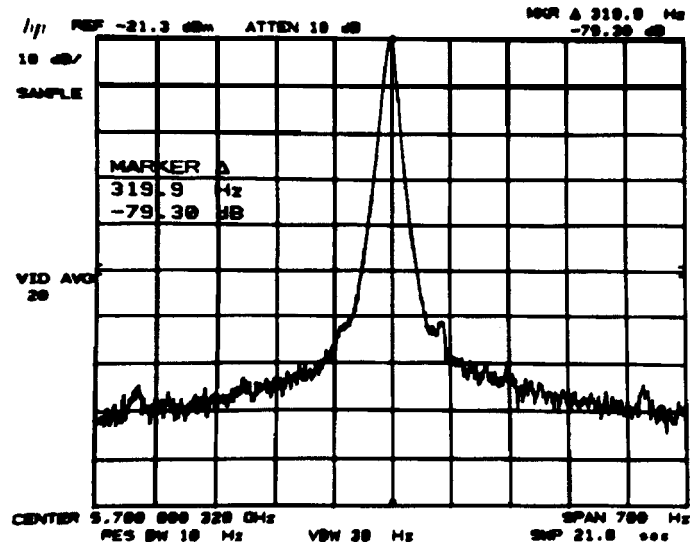

Figure 2-23. Noise Sidebands Measurement

5. Key in the following on the analyzer under test:

[CENTER FREQUENCY] 5.7 GHz
 [FREQUENCY SPAN]5 kHz

6. Wait for completion of the sweep (the asterisk * at the upper right of the display will disappear), then press MARKER [PEAK SEARCH], [MKR → CF], [MKR → REF LVL].

7. Change [FREQUENCY SPAN] to 700 Hz. Wait for completion of the sweep, then press MARKER [PEAK SEARCH], [MKR → CF]. Wait again for the completion of the sweep.

8. Press [SHIFT], [VIDEO BW]^G to initiate video averaging. When the VID AVG readout at the left edge of the display reaches 20, press [SHIFT], TRACE B [BLANK].

9. Press MARKER [PEAK SEARCH], [In] and key in 320 Hz.

Record the MARKER A amplitude: _____ dBc.

See Figure 2-23.

10. Find the equivalent noise power bandwidth, BW_{enp} , for the 10 Hz resolution bandwidth filter by multiplying the 3 dB bandwidth recorded in Table 2-5 of the Resolution Bandwidth Accuracy Test by 1.13:

$$BW_{enp} = 1.13 \times \text{Hz}$$

= _____ Hz

12. Noise Sidebands Test

11. A correction factor of 2.5 dB must be added to the value measured in step 9 to compensate for logarithmic amplification and envelope detection. Add this correction, then subtract $10 \log(BW_{\text{enp}})$ to compute the noise sideband level in dBc referenced to a 1 Hz bandwidth:

$$\frac{\text{_____ dBc} + 2.5 \text{ dB} - 10 \log(BW_{\text{enp}})}{\text{_____ dBc/Hz}} =$$

The result should be $< -80 \text{ dBc/1 Hz}$.

12. Press (SHIFT) **[SWEEP TIME]**^H.
13. Change **[FREQUENCY SPAN]** to 2.5 kHz.
14. Press **[SHIFT]**, **[VIDEO BW]**^G. When the VID AVG readout reaches 10, press **[SHIFT]**, TRACE B **[BLANK]**.
15. Press **MARKER** **[PEAK SEARCH]**, **[Δ]** and key in 1 kHz.

Record the MARKER A amplitude: _____ dBc.

16. Compute the noise sideband level at a 1 kHz offset by the procedure of steps 10 and 11, but find BW_{enp} for the 30 Hz resolution bandwidth filter:

$$\text{_____ dBc} + 2.5 \text{ dB} - 10 \log(BW_{\text{enp}}) = \text{dBc/1 Hz}$$

The result should be $< -85 \text{ dBc/1 Hz}$.

17. Press **[SHIFT]** **[SWEEP TIME]**^H.
18. Change **[FREQUENCY SPAN]** to 25 kHz.
19. Press **[SHIFT]** **[VIDEO]**^G. When the VID AVG readout reaches 20 or higher, press **[SHIFT]**, TRACE B **[BLANK]**.
20. Press **MARKER** **[PEAK SEARCH]**, **[a]** and key in 10 kHz.

Record the MARKER A amplitude: _____ dBc.

21. Compute the noise sideband level at a 10 kHz offset by the procedure of steps 10 and 11, using the 3 dB bandwidth recorded in Table 2-5 for the 300 Hz resolution bandwidth filter:

$$\frac{\text{_____ dBc} + 2.5 \text{ dB} - 10 \log(BW_{\text{enp}})}{\text{_____ dBc/Hz}} =$$

The result should be $< -90 \text{ dBc/1 Hz}$.

22. Press **[SHIFT]** **[SWEEP]**.
23. Change **[FREQUENCY SPAN]** to 250 kHz.
24. Press **[SHIFT]** **[VIDEO BW]**^G. When the VID AVG readout reaches 30 or greater, press **[SHIFT]**, TRACE B **[BLANK]**.
25. Press **MARKER** **[PEAK SEARCH]** **[Δ]** and key in 100 kHz.

Record the MARKER A amplitude: _____ dBc.

26. Compute the noise sideband level at a 100 kHz offset by the procedure of steps 10 and 11, using BW_{enp} for the 3 kHz filter:

$$\text{_____ dBc} + 2.5 \text{ dB} - 10 \log(BW_{\text{enp}}) = \text{dBc/1 Hz}$$

The result should be $< -105 \text{ dBc/1 Hz}$.

13. Line-Related Sidebands Test

Specification

Offset from Carrier	Center Frequency	Sidebands
<360 Hz	100 MHz to 5.8 GHz	-50 dBc
360 Hz to 2 kHz	100 Hz to 100 MHz	-75 dBc

Option 400: For center frequencies >100 Hz and <5.8 GHz:

Offset from Carrier	Center Frequency	Sidebands
≤2 kHz	100 Hz to 5.8 GHz	-55 dBc
2 kHz to 5.5 kHz	100 Hz to 5.8 GHz	-65 dBc

Description The line-related sidebands are measured on signals of 100 MHz, 2.4 GHz, 2.6 GHz, and 5.7 GHz. A second HP 8566A/B Spectrum Analyzer is used as the signal source for this test. Therefore, if measured values are not within specified limits, either analyzer may be at fault.

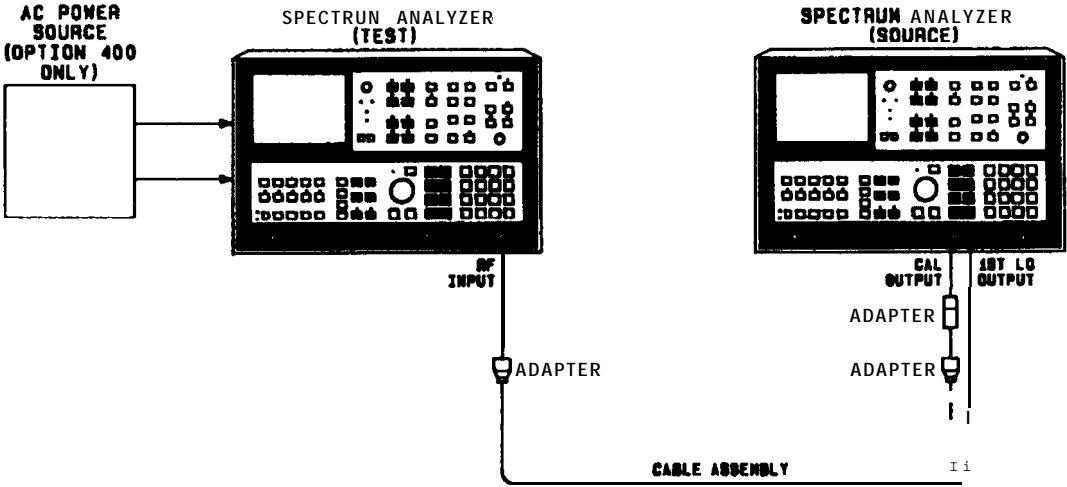

Figure 2-24. Line Related Sidebands Test Setup

13. Line-Related Sidebands Test

Equipment	Spectrum Analyzer (1ST LO OUTPUT) HP 8566A/B
	AC Power Source (Option 400 ONLY) California Instruments Model 153T
	Adapter, Type N (m) to SMA (f) (2 required) 1250-1250
	Adapter, Type N (f) to BNC (m) 1250-0077
	Cable Assembly, SMA Male Connectors 5061-1086

- Procedure**
1. Allow both analyzers to warm up for at least one-half hour with LINE switch in either the STANDBY or ON position.
 2. Connect CAL OUTPUT to RF INPUT on one of the analyzers. Press **2 - 22 GHz** then **RECALL** **9** and adjust FREQ ZERO control for maximum signal amplitude. Repeat this frequency calibration on the other analyzer. When complete, press **2 - 22 GHz** on each analyzer.

3. Connect CAL OUTPUT of source analyzer to RF INPUT of analyzer under test as shown in Figure 2-24.

4. Key in the following on the analyzer under test:

CENTER FREQUENCY	100 MHz
FREQUENCY SPAN	1.2 kHz

Wait for asterisk (*) in upper-right of display to disappear.

5. Press **MARKER** **[PEAK SEARCH]**, **MKR → CF**, **MKR → REF LVL** and wait for asterisk (*) to disappear. Trace should now be centered on display.
6. Press **SHIFT**, **VIDEO BW**^G, **SWEEP** **SINGLE**, **1 0** **Hz μ sec** to initiate video averaging of 10 sweeps.
7. When VID AVG = 10, press **SHIFT**, **TRACE B** **BLANK**, **TRACE A** **VIEW**.
8. Press **MARKER** **[PEAK SEARCH]** **[a]** and position the marker at the peaks of the line-related sidebands separated from the signal by multiples of the line frequency (e.g., 120, 180, 240, 300, 360, 420, 480, and 540 Hz for a 60 Hz line frequency). The fundamental line frequency cannot be resolved. Refer to Figure 2-25.

13. Line-Related Sidebands Test

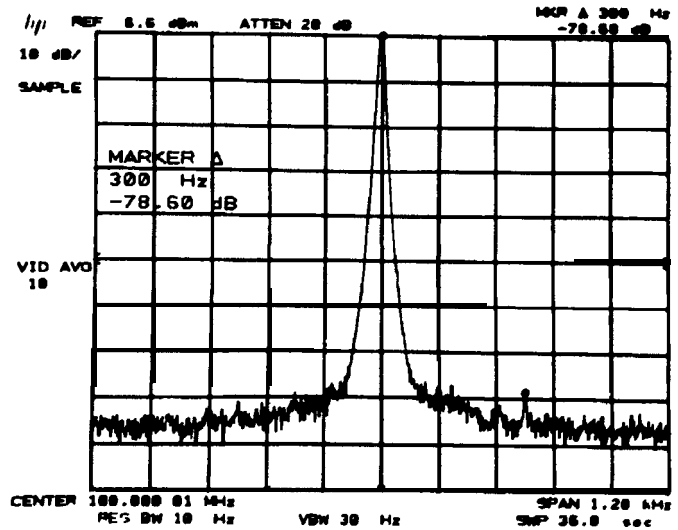

Figure 2-25. Line-Related Sidebands Measurement

9. The MARKER A amplitude for all line-related sidebands <360 Hz away from the signal should be <-70 dB. The MARKER A amplitude for all line-related sidebands from 360 Hz to 600 Hz away from the signal should be <-75 dB.

Largest Level <360 Hz _____ dB a t H z

Largest Level 360 to 600 Hz _____ dB at H z

10. Press **(SHIFT)** **(SWEEP TIME)**^H, **(SWEEP)** **(CONT)**, **(TRACE A)** **(CLEAR-WRITE)**.

11. Connect 1ST LO OUTPUT of source analyzer to RF INPUT of analyzer under test as shown in Figure 2-24.

12. Key in the following on the source analyzer:

(CENTER FREQUENCY) 2.4 GHz
(FREQUENCY SPAN) 0 Hz
(SHIFT) **(MKR → REF LVL)**^R (Display diagnostics for convenience)
(SHIFT) **(RES BW)**^F (YTO Pretest Mode)
(SWEEP) **(SINGLE)**

The first line of the diagnostic display and the CENTER readout should both now indicate 2.400 000 000 GHz. This is the 1ST LO OUTPUT frequency.

13. Key in **(CENTER FREQUENCY)** 2.4 GHz and **(REFERENCE LEVEL)** + 10 dBm on the analyzer under test. Wait for asterisk (*) to disappear.
14. Repeat steps 5 through 8.
15. The MARKER A amplitude for all line-related sidebands <360 Hz away from the signal should be <-60 dB.

Largest Level <360 Hz _____ dB a t H z

13. Line-Related Sidebands Test

16. Press **(SHIFT)**, **(SWEEP TIME)^H**, SWEEP **(CONT)**, TRACE A **(CLEAR-WRITE)**.
17. Change **(CENTER FREQUENCY)** of both the source and test analyzer to 2.6 GHz. Wait for asterisk (*) to disappear.
18. Press MARKER (OFF), **(PRESEL PEAK)** and wait for PEAKING! message to disappear from the CRT.
19. Repeat steps 5 through 8.
20. The MARKER A amplitude for all line-related sidebands <360 Hz away from the signal should be <-60 dB.
Largest Level <360 Hz _____dB a t H z
21. Press **(SHIFT)**, **(SWEEP TIME)^H**, SWEEP **(CONT)**, TRACE A **(CLEAR-WRITE)**.
22. Change **(CENTER FREQUENCY)** of both the source and test analyzer to 5.7 GHz. Wait for asterisk (*) to disappear.
23. Press MARKER **(OFF)**, **(PRESEL PEAK)** and wait for the PEAKING! message to disappear from the CRT.
24. Repeat steps 5 through 8.
25. The MARKER A amplitude for all line-related sidebands <360 Hz away from the signal should be <-60 dB.
Largest Level <360 Hz _____dB a t H z

Option 400

1. Set the AC power source output equal to the required line voltage and frequency. The analyzer under test should be operated at 400 Hz and the source analyzer at 50 to 60 Hz.
2. Allow both analyzers to warm up for at least one-half hour with LINE switch in either STANDBY or ON position.
3. Perform frequency calibration of each analyzer as specified in step 2 of standard instrument procedure.
4. Connect 1ST LO OUTPUT of source analyzer to RF INPUT of analyzer under TEST and key in settings on source analyzer as specified in step 12 of standard instrument procedure.
5. Key in **(CENTER FREQUENCY)** 2.4 GHz, **(FREQUENCY SPAN)** 1 MHz on analyzer under test.
6. Press MARKER **(PRESEL PEAK)** and wait for PEAKING! message to disappear from display.
7. Press MARKER **(PEAK SEARCH)**, **(MKR → CF)**, **(MKR → REF LVL)**, **(SIGNAL TRACK)**.
8. Change **(FREQUENCY SPAN)** to 12 kHz. Wait for signal trace to be centered.
9. Change **(RES BW)** to 30 Hz.
10. Press **(SHIFT)**, **(VIDEO BW)^G**, SWEEP **(SINGLE)**, **(1)** **(0)** **(Hz μV μsec)** to initiate video averaging of 10 sweeps.
11. When the VID AVG readout reaches 10, press **(SHIFT)**, TRACE B **(BLANK)**, TRACE A (VIEW).

13. Line-Related Sidebands Test

12. Press **MARKER** (PEAK SEARCH), [al and position the marker at the peaks of the line-related sidebands separated from the signal by multiples of the line frequency; for example, 400 Hz, 800 Hz, 1200 Hz, . . .
13. The **MARKER A** amplitude for all line sidebands below 2 kHz should be < -55 dB. The A amplitude for sidebands from 2 kHz to 5.5 kHz should be < -65 dB.
Largest Level < 2 kHz _____ dB a t H z
Largest Level < 2 kHz to 5.5 kHz _____ dB at
H z
14. Change (CENTER FREQUENCY) of source analyzer to 5.7 GHz and repeat steps 5 through 13 for 5.7 GHz.

14. Average Noise Level Test

Related Adjustment Last Converter Adjustments

Specification Displayed average noise level (0 dB input attenuation, 10 Hz resolution bandwidth):

Non-Preselected	Preselected
< -95 dBm, 100 Hz to 50 kHz	< -132 dBm, 2.0 GHz to 5.8 GHz
< -112 dBm, 50 kHz to 1 MHz	< -125 dBm, 5.8 GHz to 12.5 GHz
< -134 dBm, 1 MHz to 2.5 GHz	< -119 dBm, 12.5 GHz to 18.6 GHz
	< -114 dBm, 18.6 GHz to 22 GHz

Description The displayed average noise level is measured in a 10 Hz bandwidth at various frequencies with no signal applied to the analyzer input.

Equipment 50 Ohm Coaxial Termination HP 909A, Option 012

- Procedure**
1. Press **2 - 22 GHz**.
 2. Connect CAL OUTPUT to RF INPUT.
 3. Press **RECALL** **8**. Adjust AMPTD CAL for a MARKER amplitude of -10.00 dBm f0.02 dB.
 4. Disconnect CAL OUTPUT. Terminate RF INPUT with a 50 ohm coaxial termination.
 5. Press **0 - 2.5 GHz**. Key in settings as follows:

START FREQ8 0 Hz
STOP FREQ	180 Hz
REFERENCE LEVEL	-70 dBm
ATTEN	0 dB
VIDEO BW	Hz
 6. Press **(SHIFT) VIDEO BW**^G. Wait about 2 minutes for the VID AVG readout to reach 10 sweeps or more, then press **(SHIFT) TRACE B BLANK**.
 7. Press **MARKER** **(NORMAL)**. Tune to 100 Hz, or the nearest frequency that is not on the slope of the LO feedthrough or on a line-related sideband (e.g., 120 Hz). Refer to Figure 2-26.

14. Average Noise Level Test

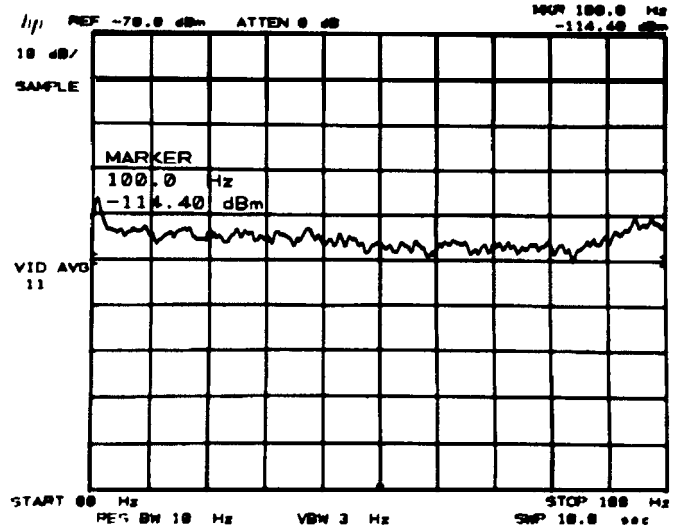

Figure 2-26. Average Noise Level Measurement

8. Read the noise level from the MARKER amplitude readout. The value should be less than -95 dBm.

_____dBm

9. Key in the following settings:

CENTER FREQUENCY		51 kHz
FREQUENCY SPAN 0 Hz
SWEEP TIME	20 ms

10. Wait several seconds for the trace to stabilize (VID AVG >20). Read the amplitude from the MARKER readout. The value should be less than -112 dBm.

_____dBm

11. Set CENTER FREQUENCY according to Table 2-18. At each setting allow several seconds for the trace to stabilize before reading the amplitude from the MARKER readout. The maximum allowable level for each frequency is given in the table.

14. Average Noise Level Test

Table 2-18. Average Noise Level

(CENTER FREQUENCY)	MARKER Amplitude (dBm)	Maximum Amplitude (dBm)
2.0 MHz		-134
1.001 GHz		-134
2.499 GHz		-134
2.510 GHz		-132
5.799 GHz		-132
5.810 GHz		-125
12.499 GHz		-125
12.510 GHz		-119
18.59 GHz		-119
18.61 GHz		-114
22.0 GHz		-114

15. Residual Responses Test

Specification	<p><-100 dBm, 100 Hz to 5.8 GHz</p> <p><-95 dBm, 5.8 GHz to 12.5 GHz</p> <p><-85 dBm, 12.5 GHz to 18.6 GHz <-80 dBm, 18.6 GHz to 22 GHz</p>															
Description	<p>The spectrum analyzer is tested for residual responses across its frequency range with no signal applied and 0 dB input attenuation.</p>															
Equipment	<p>50 Ohm Coaxial Termination HP 909A, Option 012</p>															
Procedure	<ol style="list-style-type: none"> 1. Press 2 - 22 GHz. 2. Connect CAL OUTPUT to RF INPUT. Press (RECALL) 8. 3. Adjust AMPTD CAL for a MARKER amplitude of -10.00 dBm ±0.02 dB. 4. Press 0 - 2.5 GHz. Disconnect CAL OUTPUT and terminate RF INPUT with a 50 ohm coaxial termination. 5. Key in the following: <table border="0" style="margin-left: 40px;"> <tr> <td>REFERENCE LEVEL</td> <td>.</td> <td>-20 dBm</td> </tr> <tr> <td>ATTEN</td> <td>.</td> <td>0 dB</td> </tr> <tr> <td>RES BW</td> <td>.</td> <td>30 kHz</td> </tr> <tr> <td>VIDEO</td> <td>.</td> <td>1 kHz</td> </tr> <tr> <td>STOP FREQ</td> <td>.</td> <td>1.5 GHz</td> </tr> </table> 6. Press DISPLAY LINE ENTER and key in -100 dBm. <hr/> <p>Note There should be at least 3 dB margin between the noise trace and the display line so that any residual responses may be distinguished from the noise. It may be necessary to reduce the resolution or video bandwidths from the settings given in this procedure to achieve this margin. If this causes the MEAS UNCAL message to appear, it will be necessary to reduce the frequency span and use more sweeps to cover the frequency range.</p> <hr/> <ol style="list-style-type: none"> 7. Press TRACE A CLEAR-WRITE, SWEEP SINGLE. Wait for completion of the sweep. (See Figure 2-27.) 	REFERENCE LEVEL	-20 dBm	ATTEN	0 dB	RES BW	30 kHz	VIDEO	1 kHz	STOP FREQ	1.5 GHz
REFERENCE LEVEL	-20 dBm														
ATTEN	0 dB														
RES BW	30 kHz														
VIDEO	1 kHz														
STOP FREQ	1.5 GHz														

15. Residual Responses Test

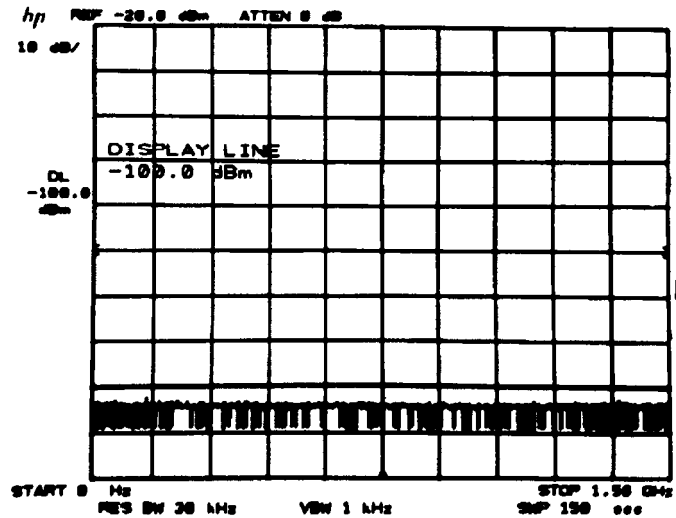

Figure 2-27. Residual Responses Measurement

8. Look for any residual responses at or above the display line. If a residual is suspected, press SWEEP **(SINGLE)** again and see if the response persists. A residual will persist on repeated sweeps, but a noise peak will not. Any residual responses must be below the display line.

Largest Residual Level _____ dBm at
H Z

9. If a response appears to be marginal, perform the following check to determine whether or not it exceeds the specification:
- Press **(SAVE) (1)**.
 - Press **MARKER (NORMAL)** and place the marker on the peak of the response in question.
 - Press **MARKER (SIGNAL TRACK)** then activate SWEEP **(CONT)**.
 - Reduce **(FREQUENCY SPAN)** to 1 MHz. Reduce **(RES BW)** until there is at least a 7 dB margin between the display line and the average noise level. The amplitude of the response must be less than the display line setting.
 - Press **(RECALL) (1)** to resume the search for residuals.
10. Key in control settings as follows:

(START FREQ) 1.4 GHz
(STOP FREQ) 2.5 GHz

16. Harmonic and Intermodulation Distortion Test

Specification Second Harmonic Distortion

Center Frequency	Level at Mixer	Harmonic Distortion
50 MHz to 700 MHz Non-Preselected	≤ -40 dBm	< -80 dBc
100 Hz to 2.5 GHz Non-Preselected	≤ -40 dBm	< -70 dBc
2 to 22 GHz Preselected	≤ -10 dBm	< -100 dBc

Third Order Intermodulation Distortion

Third-Order Intercept (TOI): $> +5$ dBm, 100 Hz to 5 MHz
 $> +7$ dBm, 5 MHz to 5.8 GHz
 $> +5$ dBm, 5.8 GHz to 18.6 GHz

Description

Second harmonic distortion in the non-preselected and preselected bands is checked with a signal source and low-pass filter. The low-pass filter ensures that the harmonics measured are due to the analyzer and not the source. Third-order intermodulation distortion is measured in the non-preselected and preselected bands with two signal sources. To prevent source interaction, the synthesizer outputs are padded and combined in a reactive power divider.

16. Harmonic and Intermodulation Distortion Test

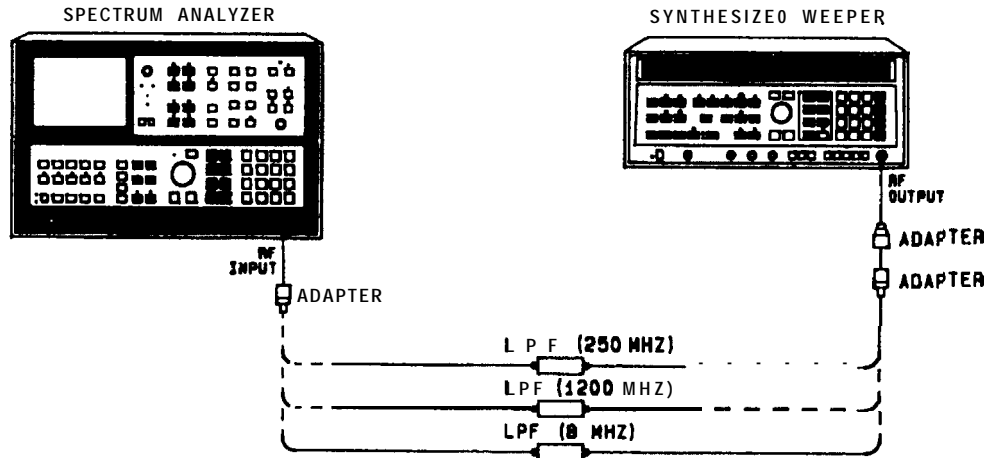

Figure 2-28. Harmonic Distortion Test Setup

Note

Equipment listed is for two test setups, Figure 2-28 and Figure 2-29.

Equipment

Synthesized Sweeper	HP 8340A
Synthesized Signal Generator	HP 8672A
Power Meter	HP 436A
Power Sensor	HP 8485A
Reactive Power Divider	Omni-Spectra 2090-6202-00
20 dB Attenuator (2 required)	HP 8493B, Option 020
3 dB Attenuator	HP 8493B, Option 003
Low-Pass Filter (250 MHz)	K&L 5L380-250-B/B
Low-Pass Filter (8 GHz)	K&L 6L250-8000-NP/N
Low-Pass Filter (1200 MHz)	HP 360B
61 cm (24 in.) Cable Assembly, SMA Male Connectors (2 required) 5061-1086	
Adapter, Type N (m) to BNC (f) (2 required)	1250-0780
Adapter, Type N (m) to SMA (f)	1250-1250
Adapter, Type N (f) to SMA (f)	86290-60005
Adapter, SMA Female Connectors	1250-1158
Adapter, SMA Male Connectors	1250-1159
BNC Tee (2 required)	1250-0781

Procedure

16. Harmonic and Intermodulation Distortion Test

Harmonic Distortion

1. Set the synthesized sweeper for an output CW frequency of 230.00 MHz and an output level of approximately -30 dBm.
2. Press **(2 - 22 GHz)** on the analyzer. Key in the following settings:

CENTER FREQUENCY	230 MHz
(FREQUENCY SPAN)	100 kHz
(REFERENCE LEVEL)	-30 dBm
3. Connect equipment as shown in Figure 2-28, using the 250 MHz low-pass filter. Adjust the synthesized sweeper output level to place peak of signal trace at the top graticule line.
4. Press DISPLAY LINE **(ENTER)** and key in - 110 dBm.
5. Press MARKER **(PEAK SEARCH)**, **(MKR → CF)**, **(MKR/Δ → STP SIZE)**.
6. Activate **(CENTER FREQUENCY)** and press **(↑)** to tune to the second harmonic of the input signal.
7. Reduce **(FREQUENCY SPAN)** to 10 kHz and **(VIDEO BW)** to 30 Hz. Reduce **(RES BW)** if necessary, for a margin of ≥ 5 dB between the displayed noise and the display line.
8. The second harmonic should be below the display line (<-80 dBc).

Second harmonic level of 230 MHz _____dBc

9. Replace the 250 MHz low-pass filter with the 1200 MHz low-pass filter.
10. Set the synthesized sweeper for an output CW frequency of 800.000 MHz.
11. Press **(2 - 22 GHz)** on the analyzer. Key in:

(CENTER FREQUENCY)	800 MHz
(FREQUENCY SPAN)	100 kHz
(REFERENCE LEVEL)	-30 dBm

12. Adjust synthesized sweeper output level to place peak of signal trace at the reference level line.

Note

If unable to locate a harmonic distortion product, increase the output level by 10 dB. Be sure to return the output level to the original setting before making a measurement.

13. Press DISPLAY LINE **(ENTER)** and key in -100 dBm.
14. Press MARKER **(PEAK SEARCH)**, **(MKR → CF)**, **(MKR/Δ → STP SIZE)**, **(CENTER FREQUENCY)** **(↑)**, **(FREQUENCY SPAN)** 10 kHz.
15. The second harmonic of the input signal should be below the display line (<-70 dBc).

Second harmonic level of 800 MHz		dBc
----------------------------------	--	-----
16. Replace the 1200 MHz low-pass filter with the 8 GHz low-pass filter.
17. Set the synthesized sweeper for an output frequency of 7200.000 MHz and an output level of 0 dBm.

16. Harmonic and Intermodulation Distortion Test

18. Press **2 - 22 GHz** on the analyzer. Key in the following:

CENTER FREQUENCY	7.2 GHz
FREQUENCY SPAN	100 kHz
19. Press **MARKER** **(PEAK SEARCH)**, **(MKR → CF)**.
20. Set **(FREQUENCY SPAN)** to 10 kHz. Press **MARKER** **(PEAK SEARCH)**, **(MKR → CF)**, **(MKR/Δ → STP SIZE)**.
21. Adjust synthesized sweeper output level to place peak of signal trace at the reference level line.
22. Press **DISPLAY LINE** **(ENTER)** and key in -80 dBm.
23. Activate **(CENTER FREQUENCY)** and press **(↑)** to tune to the second harmonic of the input signal.
24. Key in the following:

(REFERENCE LEVEL)	-20 dBm
(FREQUENCY SPAN)	1 kHz
25. The second harmonic should be below the display line (<- 100 dBc).
 Second harmonic level of 7200 MHz _____dBc

Intermodulation Distortion

26. Set both synthesized sources as follows:

RANGE	+ 10 dBm
METER MODE	LEVEL
RF OUTPUT	OFF
ALC	INT
AM	OFF
FM DEVIATION MHz	OFF
27. Connect equipment as shown in Figure 2-29 with “output” of power divider connected to power sensor. The **FREQ REFERENCE** switch on the rear panel of the analyzer should be set to **INT** and the **FREQ REFERENCE** switch on both synthesized source rear panels should be set to **EXT**.
28. Set one synthesized source for an output frequency of 2099.500 MHz, the other to 2100.500 MHz.
29. Set one synthesized source **RF OUTPUT** switch to **ON** and adjust the output power level for a power meter indication of -25.00 dBm f0.20 dB. Return the **RF OUTPUT** switch to the **OFF** setting.

16. Harmonic and Intermodulation Distortion Test

30. Set the other synthesized source RF OUTPUT switch to ON and adjust the output power level for a power meter indication of $-25.00 \text{ dBm} \pm 0.20 \text{ dB}$. Set both synthesized source RF OUTPUT switches to the ON position (power meter reading should be approximately -22 dBm).
31. Connect output of power divider to analyzer RF INPUT as shown in Figure 2-29.

Note

Be careful to flex the cable assemblies as little as possible, as flexing can cause a change in the measured power level. To minimize flexing, place the power sensor close to the analyzer input.

32. Press **[2 - 22 GHz]** on the spectrum analyzer.

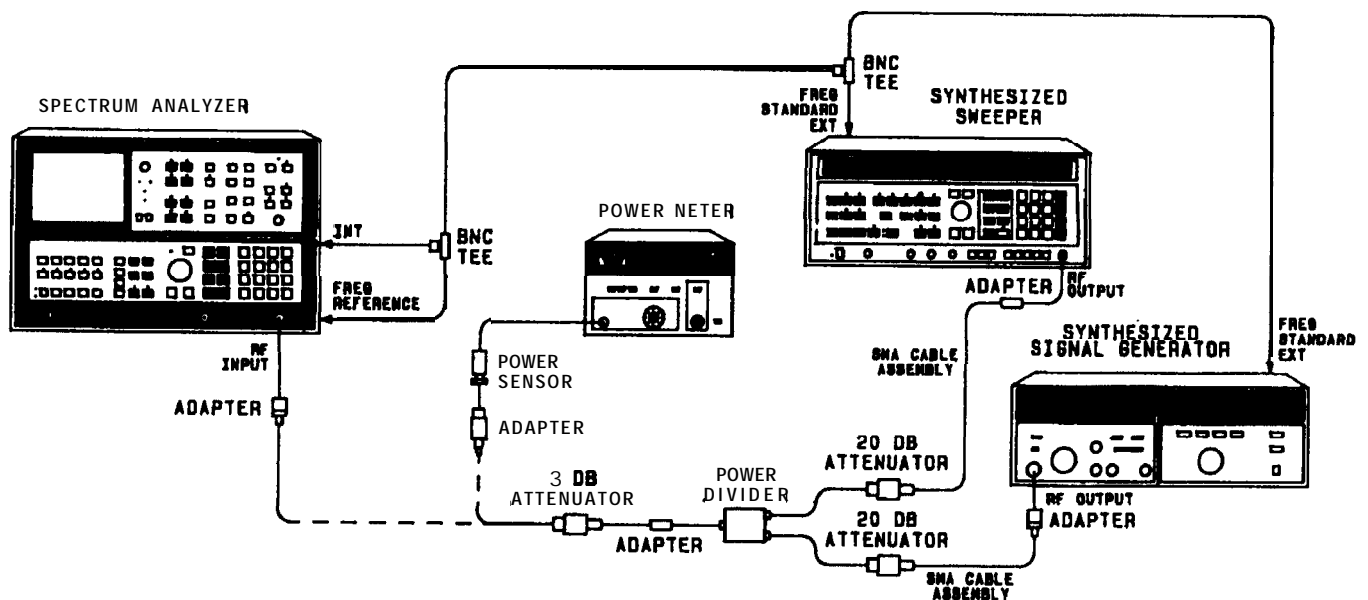

Figure 2-29. Intermodulation Distortion Test Setup

33. Key in analyzer settings as follows:

[CENTER FREQUENCY]	2099.5 MHz
[CF STEP SIZE]	1 MHz
[FREQUENCY SPAN]	2 kHz
[ATTEN]	0 dB

34. Wait for completion of the sweep (asterisk should not appear on display), then press **MARKER** **[PEAK SEARCH]**, **[MKR → CF]**. Wait for completion of the sweep.
35. Press **MARKER** **[Δ]**. Activate **[CENTER FREQUENCY]** and press **[↓]** once to tune to the third order product at 2098.5 MHz.

16. Harmonic and Intermodulation Distortion Test

36. Wait for completion of the sweep, then press MARKER
PEAK SEARCH.

Record the MKR A amplitude: _____dB.

37. Press **⇧** three times to tune to the third order product at 2101.5 MHz. Wait for completion of the sweep, then press MARKER
PEAK SEARCH.

Record the MKR A amplitude: _____dB.

38. Choose the smallest MKR A amplitude in steps 36 and 37.

Record its absolute value: _____dB.

(For example, if one MKR A amplitude is -82 dB and the other is -79 dB, record +79 dB.) This value is S, the third order suppression.

39. Compute the third order intercept (TOI) as follows:

TOI = P + S/2, where P = input signal power, and S = third order suppression from step 38.

$$\text{TOI} = -25 \text{ dBm} + \text{_____dB}/2$$
$$= \text{_____dBm}$$

40. The result should be > + 7 dBm. Refer to Figure 2-30.

TOI for signals of 2099.5 MHz and 2100.5 MHz
_____dBm

16. Harmonic and Intermodulation Distortion Test

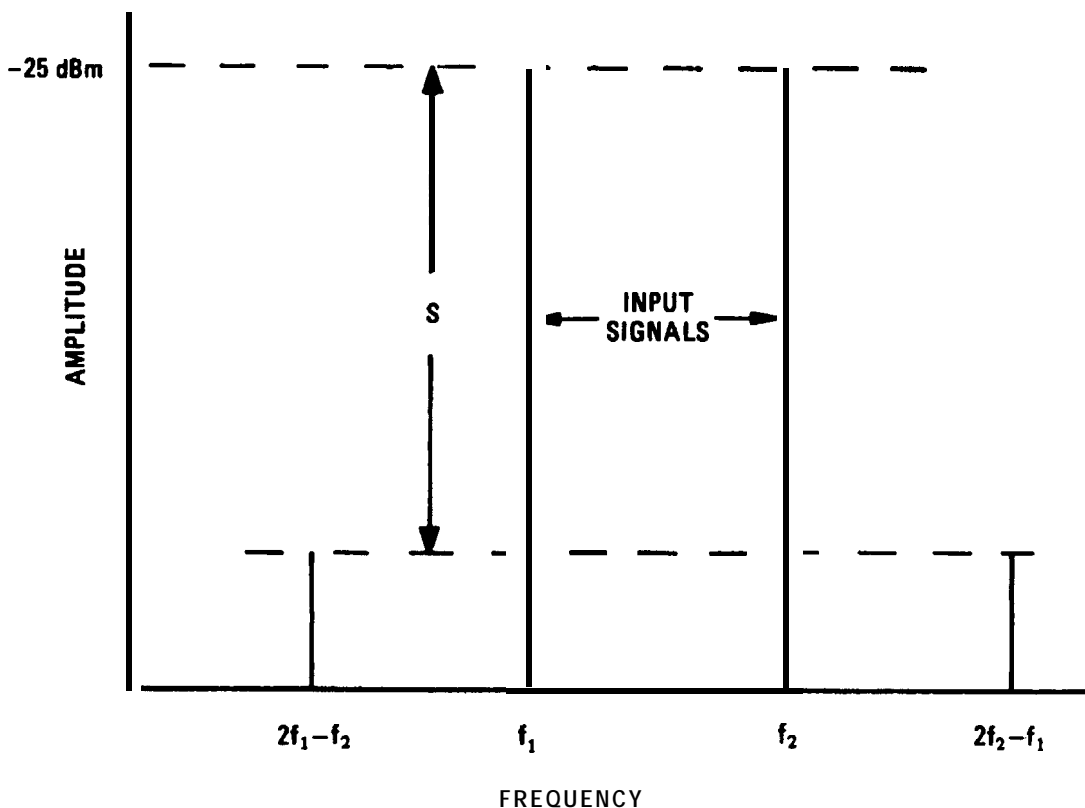

Figure 2-30. Third Order Intermodulation Products

41. Set one synthesizer to 3999.500 MHz, the other to 4000.500 MHz.
42. Connect the output of the power divider to the power sensor as shown in Figure 2-29.
43. Set RF OUTPUT switch on both synthesizers to the OFF position. Set output levels of synthesizers according to the procedure of steps 29 and 30.
44. Connect the output of the power divider to the analyzer input as shown in Figure 2-29.
45. Key in the following analyzer settings:

<u>CENTER FREQUENCY</u>	3999.5 MHz
<u>FREQUENCY SPAN</u>1 MHz
<u>REFERENCE LEVEL</u>	-20 dBm

46. Press MARKER (OFF), PEAK SEARCH and wait for PEAKING! message to disappear from display.
47. Set FREQUENCY SPAN to 2 kHz and wait for completion of the sweep.
48. Press MARKER PEAK SEARCH, MKR → REF LVL. Wait for completion of the sweep.

16. Harmonic and Intermodulation Distortion Test

49. Press MARKER Δ . Activate [CENTER FREQUENCY] and press \Downarrow once to tune to the third order product at 3998.5 MHz. Wait for completion of the sweep.

50. Press MARKER [PEAK SEARCH]

Record the MKR A amplitude: _____dB

51. Press \Uparrow three times to tune to the third order product at 4001.5 MHz. Wait for completion of the sweep, then press MARKER [PEAK SEARCH].

Record the MKR A amplitude: _____dB.

52. Choose the smallest MKR A amplitude in steps 50 and 51.

Record its absolute value: S = _____dB.

53. Compute the TOI:

$$\begin{aligned} \text{TOI} &= P + S/2 \\ &= -25 \text{ dBm} + \text{_____dB}/2 \\ &= \text{_____dBm} \end{aligned}$$

54. The result should be $> + 7 \text{ dBm}$.

TOI for signals of 3999.5 MHz and 4000.5 MHz
_____dBm

55. Repeat steps 41 through 53 for the input signal frequencies and the third order products shown in Table 2-19. The TOI for each setting should be $> + 5 \text{ dBm}$.

Table 2-19. TOI Measurement Settings

Input Signal Frequencies (MHz)		Third Order Products (MHz)		Third Order Suppression (dB)	TOI (dBm)
8999.500	9000.500	8998.500	9001.500	_____	_____
13999.500	14000.499	13998.501	14001.498	_____	_____

17. Image, Multiple, and Out of Band Responses Test

Description Image and out-of-band responses are checked by setting the analyzer center frequency to several frequencies across the analyzer range and tuning a leveled signal source to the frequencies determined by the tuning equation, $F_{sig} = nF_{LO} \pm F_{IF}$. Input signals at these frequencies will excite all possible image and out-of-band responses for a given 1st LO frequency and all positive integer values of n. In this test, only values of n corresponding to the analyzer mixing modes are used. Multiple responses are checked by applying an input signal and measuring the response at those center frequencies for which a harmonic of the 1st LO mixes with the input signal.

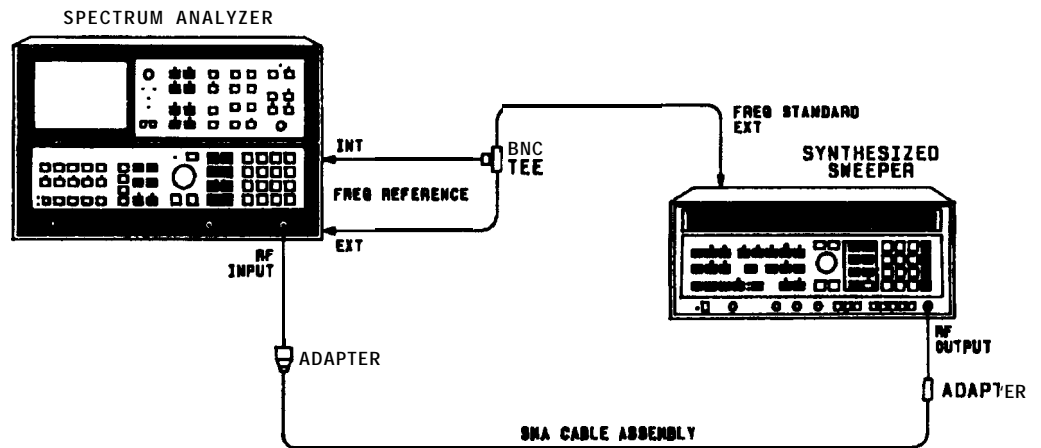

Figure 2-31. Image, Multiple, and Out-of-Band Responses Test Setup

Equipment	Synthesized Sweeper	HP 8340A
	61 cm (24 in.) Cable Assembly, SMA Male Connectors	5061-1086
	Adapter, Type N (m) to SMA (f)	1250-1250
	Adapter, SMA Female Connectors	1250-1158
	BNC Tee	1250-0781

17. Image, Multiple, and Out of Band Responses Test

Procedure

1. Connect equipment as shown in Figure 2-31 with the synthesized sweeper RF OUTPUT connected to the analyzer input.
2. Press INSTR PRESET on the synthesized sweeper. Key in the following sweeper settings:

CW FUNCTION 3000.000 MHz
POWER LEVEL 0.0 dBm

3. Press **2 - 22 GHz** on the analyzer. Key in the following analyzer settings:

[CENTER FREQUENCY] 3 GHz
[FREQUENCY SPAN] 100 kHz

4. Press DISPLAY LINE **[ENTER]** and key in -70 dBm.
5. Press MARKER **[PRESEL PEAK]** and wait for PEAKING! message to disappear from the display. Press MARKER **[NORMAL]**.
6. Adjust the power level of the synthesized sweeper to place the peak of the signal trace at the top CRT graticule line.

Note

If the maximum output power level of the synthesized sweeper is not enough to place the signal peak at the top CRT graticule line, then adjust the spectrum analyzer REFERENCE LEVEL as required to place the signal peak at the top CRT graticule line.

7. Press MARKER **[Δ]**. Using the DATA knob, determine the amplitude of the spurious response and enter the result in Table 2-20.
8. Set the synthesized sweeper to the frequencies in Table 2-20 corresponding to an analyzer center frequency of 3 GHz. The maximum allowable amplitude of the spurious response at the analyzer center frequency for each setting is shown in the table.

17. Image, Multiple, and Out of Band Responses Test

Table Z-20. Image and Out-of-Band Response

Spectrum Analyzer [CENTER FREQUENCY] (GHz)	Synthesized Sweeper Frequency (MHz)	Displayed Spurious Amplitude	
		Measured (dBc)	Maximum (dBc)
3	3642.800		-70
	6321.400		-60
	6964.200		-60
6	2517.900		-60
	3160.700		-60
	5357.200		-70
9	4017.900		-60
	4660.700		-60
	8357.200		-70
	112696.500		-60
	113339.300		-60
12	5517.900		-60
	6160.700		-60
	11357.200		-70
	17196.500		-60
	17839.300		-60
5	4571.500		-60
	5214.300		-60
	9464.300		-60
	10107.100		-60
	14357.200		-70
7	5238.100		-60
	5880.900		-60
	10797.700		-60
	11440.500		-60
	16357.200		-70
9	4348.300		-60
	4991.100		-60
	9017.900		-60
	9660.700		-60
	13687.600		-60
	14330.400		-60
	18357.200		-60
1	4848.300		-60
	5491.100		-60
	10017.900		-60
	10660.700		-60
	15187.600		-60
	115830.400		-60
	20357.200		-50

17. Image, Multiple, and Out of Band Responses Test

9. Repeat steps 4 through 9 for all remaining (CENTER FREQUENCY) and synthesized sweeper settings in Table 2-20. Steps 4 through 8 need only be done once for each (CENTER FREQUENCY) setting.
10. Set the synthesized sweeper for an output CW frequency of 5700.000 MHz.
11. Key in the following analyzer settings:

<u>(CENTER FREQUENCY)</u>	5.7 GHz
<u>(REFERENCE LEVEL)</u>	0.0 dBm
12. Press MARKER (PRESEL PEAK) and wait for PEAKING! message to disappear from display. Press MARKER (NORMAL).
13. Change (FREQUENCY SPAN) to 5 kHz. Adjust the synthesized sweeper output power level to place peak of signal trace at the top CRT graticule line.
14. Press MARKER (Δ). Using the DATA knob, determine the amplitude of the spurious response and enter the result in Table 2-21.
15. Change (CENTER FREQUENCY) to 2.36790 GHz. The multiple response at the center frequency should be below the (SHIFT), SWEEP (CONT)^T display line (≤ -70 dBc).

Multiple response at 2.36790 GHz _____ dBc
16. Press (SHIFT), (MKR/Δ → STP SIZE)^Q.
17. Set the synthesized sweeper output CW frequency and analyzer (CENTER FREQUENCY) according to Table 2-21. Before checking the amplitude of the multiples for a given signal frequency, set the input signal amplitude by the procedure of steps 11 through 14.

Table 2-2 1. Multiple Responses

Synthesized Sweeper Frequency (MHz)	<u>(CENTER FREQUENCY)</u> (Multiple Response) (GHz)	Displayed Spurious Amplitude	
		Measured (dBc)	Maximum (dB)
5700.000	2.68930		-70
6000.000	1.18930		-50
12000.000	8.107133		-70
	8.535667		-70
13000.000	1.06790		-45
	1.9107		-45
	0.53395		-45
15000.000	10.107133		-60
	10.535667		-60

18. Gain Compression Test

Specification <1.0 dB, 100 Hz to 22 GHz with ≤ -5 dBm at the input mixer

Description Gain compression is measured by changing the power level at the spectrum analyzer input mixer from -15 dBm to -5 dBm (2 to 22 GHz). The displayed signal level will change by less than 10 dB, indicating gain compression of the input mixer. Since a 10 dB change in IF gain is used to keep the signal trace near the same point on the display when the input power is increased, the error due to this IF gain change is first measured, then subtracted from the displayed deviation to give the deviation due to gain compression only.

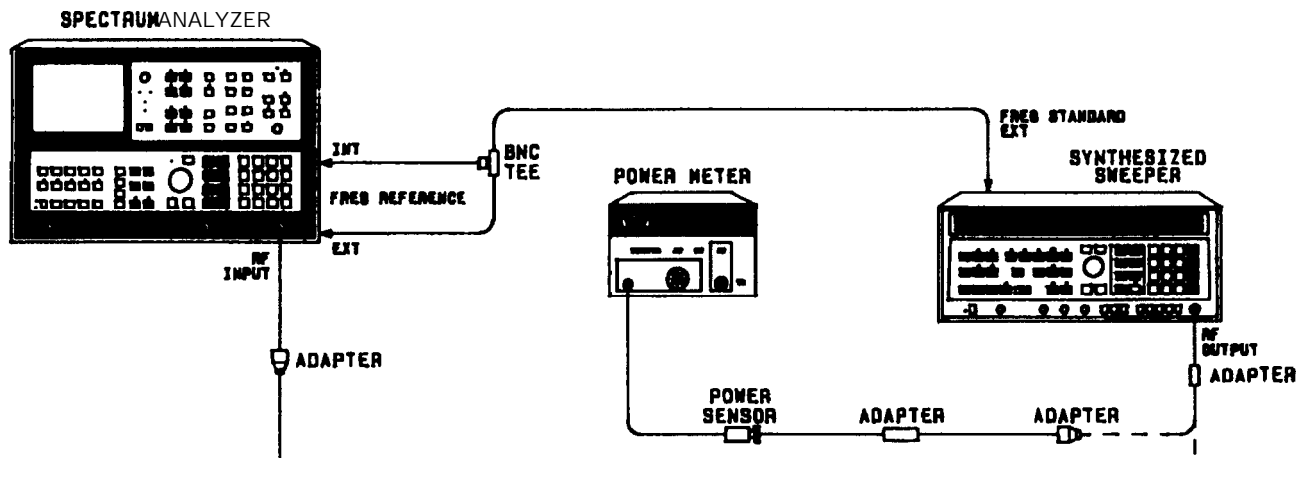

Figure 2-32. Gain Compression Test Setup

Equipment	Synthesized Signal Generator	HP 8340A
	Power Meter	HP 436A
	Power Sensor	HP 8485A
	Adapter, Type N (m) to SMA (f) (2 required)	1250-1250
	Adapter, Type N Female Connectors	1250-0777
	Adapter, SMA (f) to SMA (f)	1250-1158
	Adapter, BNC Tee (m)(f)(f)	1250-0781
	Low Loss Microwave Test Cable (APC 3.5)	8120-4921

- Procedure**
1. Press **2 - 22 GHz**, **SHIFT** **ATTEN**^I, **SHIFT** **0 - 2.5 GHz** 0 dBm on the spectrum analyzer. Set FREQ REFERENCE switch on rear panel of analyzer to INT and set FREQ STANDARD switch on rear panel of synthesizer to EXT.
 2. Set synthesizer frequency to 2000.000 MHz. Set other synthesizer controls as follows:

ALC	INT
AM	OFF
FM	OFF
RF OUTPUT	ON

18. Gain Compression Test

OUTPUT LEVEL RANGE -20 dBm

Note

Care should be taken to disturb the cable assembly as little as possible, since flexing may cause a change in the measured power level. The power sensor should be placed near the spectrum analyzer input to minimize flexing when the cable is moved.

3. Connect equipment as shown in Figure 2-32, with output of synthesizer connected to power sensor. Power is measured at the end of the cable assembly, not at the synthesizer output connector. Adjust synthesizer output level for a power meter indication of -25.00 dBm f0.05 dB.
4. Disconnect cable assembly from power sensor and connect free end to spectrum analyzer RF INPUT as indicated in Figure 2-32. Key in analyzer settings as follows:

CENTER FREQUENCY	. . . 2 GHz
FREQUENCY SPAN	. . . 0 Hz
ATTEN 0 dB
REFERENCE LEVEL -15 dBm
VIDEO BW	. . . 30 Hz
RES BW	. . . 3 MHz
5. Press the SCALE LIN pushbutton, then press (SHIFT) (RES BW) (AUTO)^A to obtain amplitude readouts in dBm. Turn the AMPTD CAL control fully clockwise.
6. Press MARKER (NORMAL) (Δ).
7. Connect cable to power sensor and adjust synthesizer output level for a power meter reading of -15.00 dBm ±0.02 dB.
8. Reconnect cable to the spectrum analyzer RF INPUT.
9. Change spectrum analyzer (REFERENCE LEVEL) to -5 dBm.

Record the MKR A amplitude: _____dB. This is the IF gain error in changing the reference level from -15 dBm to -5 dBm with 0 dB input attenuation.
10. Set (REFERENCE LEVEL) to -15 dBm. Adjust AMPTD CAL to place the signal trace approximately 1 division down from the reference level line.
11. Press MARKER (NORMAL), (Δ).
12. Connect cable to power sensor and adjust synthesizer output level for a power meter indication of -5 dBm f0.02 dB. Reconnect cable to spectrum analyzer input.
13. Change (REFERENCE LEVEL) to -5 dBm.

Record the MKR A amplitude: _____dB.
14. Subtract the value obtained in step 9 from the value recorded in step 13 to find the gain compression: _____dB. The result should be >-1.0 dB (less than 1 dB compression).
15. Press (2 - 22 GHz) on the spectrum analyzer. Press (SHIFT) (ATTEN)^I, (SHIFT) (0 - 2.5 GHz) 0 dBm.

18. Gain Compression Test

16. Set synthesizer to 3000.000 MHz. Connect cable to power sensor and adjust output level of synthesizer for an indication of -15.00 ± 0.05 dB on the power meter. Reconnect cable to the spectrum analyzer input.

17. Key in the following settings:

CENTER FREQUENCY 3 GHz
FREQUENCY SPAN1 MHz
ATTN 0 dB

18. Press **MARKER** (**PRESEL PEAK**) and wait for **PEAKING!** message to disappear from the display.

19. Press **SCALE LIN** pushbutton, then press **(SHIFT)** **(RES BW)** **(AUTO)**^A. Key in:

(REFERENCE LEVEL) -15 dBm
(FREQUENCY SPAN)0 Hz
(VIDEO BW) 30 Hz
(RES BW) MHz

20. Press **MARKER** **(NORMAL)**, **(Δ)**.

21. Connect the cable to the power sensor and adjust synthesizer level for a power meter indication of -5.00 dBm ± 0.02 dB. Reconnect cable to spectrum analyzer input.

22. Change **(REFERENCE LEVEL)** to -5 dBm. Record the MKR Amplitude: _____ dB.

23. Subtract the value recorded in step 9 from the value obtained in step 22 to find the gain compression: _____ dB. The result should be > -1.0 dB (less than 1 dB compression).

24. Press **(2 - 22 GHz)** on the spectrum analyzer. Press **(SHIFT)** **(ATTEN)**^I, **(SHIFT)** **(0 - 2.5 GHz)** 0 dBm.

25. Set synthesizer to 9000.000 MHz. Connect cable from synthesizer to power sensor and adjust synthesizer output level for a power meter reading of -15.00 ± 0.02 dB. Reconnect cable to spectrum analyzer input.

26. Key in the following analyzer settings:

(CENTER FREQUENCY) 9 GHz
(FREQUENCY SPAN)1 MHz
(ATTEN) 0 dB

27. Press **MARKER** (**PRESEL PEAK**) and wait for the **PEAKING!** message to disappear from the display.

28. Press the **SCALE LIN** pushbutton, then press **(SHIFT)** **(RES BW)** **(AUTO)**. Key in the following:

(REFERENCE LEVEL) -15 dBm
(FREQUENCY SPAN)0 Hz
(VIDEO BW) 30 Hz
(RES BW) MHz

29. Press **MARKER** **(NORMAL)**, [a.

18. Gain Compression Test

30. Connect cable to power sensor and adjust output level of synthesizer for a power meter indication of -5.00 ± 0.02 dB. Reconnect cable to spectrum analyzer input.
31. Change REFERENCE LEVEL to -5 dBm.
Record the MKR A amplitude: _____dB.
32. Subtract the value recorded in step 9 from the value obtained in step 31 to find the gain compression: _____dB. The result should be > -1.0 dB (less than 1 dB compression).
33. Disconnect cable from the spectrum analyzer RF INPUT. Connect the spectrum analyzer CAL OUTPUT to RF INPUT.
34. Press RECALL (8), MARKER PEAK SEARCH. Adjust AMPTD CAL for a MARKER amplitude of -10.00 dBm ± 0.02 dB.

19. 1st LO Output Amplitude Test

Specification > + 5 dBm from 2.3 GHz to 6.1 GHz

Description The power level at the 1ST LO OUTPUT connector is measured as the first LO is swept over its 2.3 GHz to 6.1 GHz range.

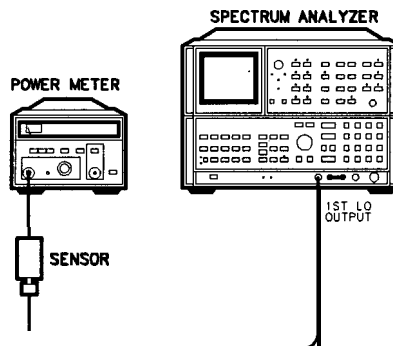

Figure 2-33. 1st LO Output Amplitude Test Setup

Equipment

Power Meter	HP 436A
Power Sensor	HP 8485A

- Procedure**
1. Press (2). Key in a (STOP FREQ) of 5.8 GHz.
 2. Set (SWEEP TIME) to 100 seconds.
 3. Calibrate power meter and sensor. Connect equipment as shown in Figure 2-33.
 4. Observe the meter indication as the analyzer sweeps from 2.0 to 5.8 GHz. The indication should be > + 5 dBm across the full sweep range.

_____dBm

20. Sweep + Tune Out Accuracy Test

Specification -1 V/GHz X Center Frequency (GHz) $\pm(2\% + 10 \text{ mV})$

Description The spectrum analyzer is set to zero frequency span and the SWEEP + TUNE OUT auxiliary output is measured with a voltmeter as the analyzer is tuned across its frequency range.

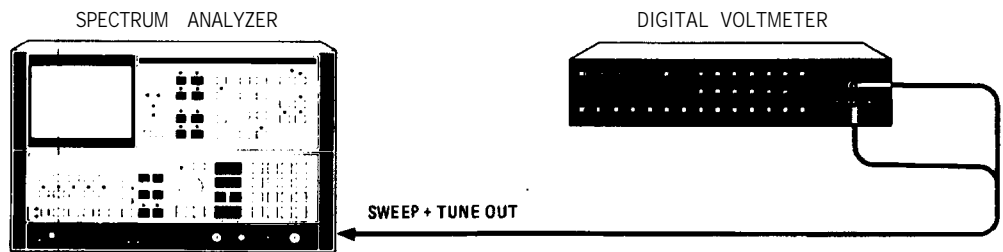

Figure 2-34. Sweep + Tune Out Accuracy Test Setup

Equipment Digital Voltmeter HP 3456A

- Procedure**
1. Press **2 - 22 GHz** on the analyzer. Set **FREQUENCY SPAN** to 0 Hz
 2. Connect digital voltmeter to the SWEEP + TUNE OUT auxiliary output on the rear panel of the analyzer as indicated in Figure 2-34.
 3. Set **CENTER FREQUENCY** according to Table 2-22 and record the voltmeter readings in the table. The allowable range for each measurement is shown in the table.

20. Sweep + Tune Out Accuracy Test

Table 2-22. Sweep + Tune Out Accuracy

CENTER FREQUENCY	Voltmeter Reading (Volts)		
	Min	Actual	Max
0 Hz	-0.010		+ 0.010
1 MHz	-0.011		+ 0.009
12 MHz	-0.022		-0.002
130 MHz	-0.143		-0.117
670 MHz	-0.693		-0.647
1.3 GHz	- 1.336		-1.264
5.7 GHz	-5.824		-5.576
12.5 GHz	-12.760		-12.240
18.6 GHz	-18.982		-18.218
22 GHz	-22.450		-21.550

21. Fast Sweep Time Accuracy Test (<20 ms)

Related Adjustment None

Specification $\pm 10\%$ for sweep times ≤ 100 seconds

Description The triangular wave output of a function generator is used to modulate a 500 MHz signal which is applied to the spectrum analyzer RF INPUT. The signal is demodulated in the zero span mode to display the triangular waveform. Sweep time accuracy for sweep times <20 ms is tested by checking the spacing of the signal peaks on the displayed waveform.

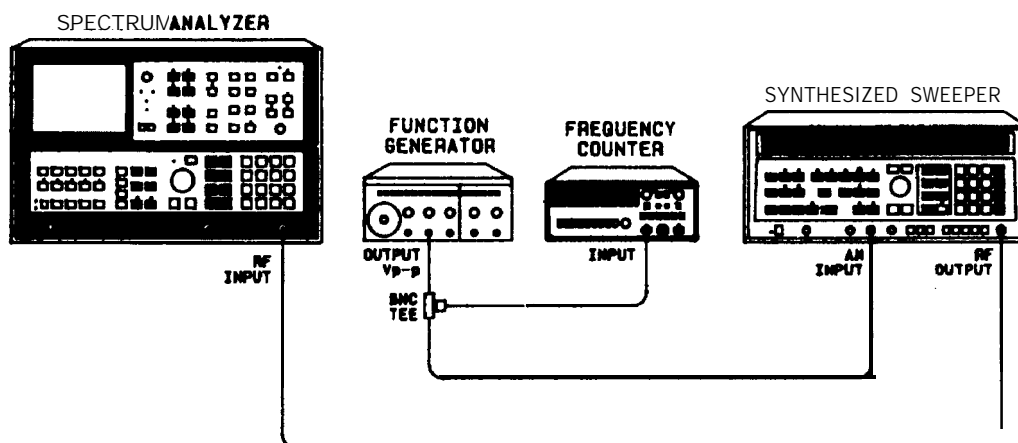

Figure 2-35. Fast Sweep Time Accuracy (<20 ms) Test Setup

Equipment

Function Generator	HP 3312A
Universal Counter	HP 5316A
Signal Generator	HP 8340A

- Procedure**
1. Connect equipment as shown in Figure 2-35.
 2. Press **2 - 22 GHz** on spectrum analyzer.
 3. Key in analyzer settings as follows:

CENTER FREQUENCY	500 MHz
FREQUENCY SPAN10 0 kHz
 4. Set synthesized sweeper for an output frequency of 500 MHz and an output power level of -10 dBm.

21. Fast Sweep Time Accuracy Test (<20 ms)

5. Press MARKER [PEAK SEARCH], [MKR → CF], [OFF].
6. Set [FREQUENCY SPAN] to 0 Hz, [RES BW] to 3 MHz, [VIDEO BW] to 3 MHz, and press TRIGGER [VIDEO].
7. Set synthesized sweeper for an amplitude-modulated output.
8. Set function generator controls as follows:
 - FUNCTION triangular wave
 - AMPLITUDE approximately 1 V_{p-p}
 - OFFSET CAL position (in)
 - SYM CAL position (in)
 - TRIGGER PHASE FREE RUN
 - MODULATION all out
9. Key in [SWEEP TIME] 5 ms and set function generator for a reading of 2.00 f0.02 kHz.
10. Adjust spectrum analyzer TRIGGER LEVEL to place a peak of the triangular waveform on the first graticule from the left edge of the CRT display as a reference. (Adjust function generator amplitude, if necessary, to provide a signal large enough to produce a stable display.) The fifth peak from the reference should be within ±0.5 division of the sixth graticule from the left edge of the display. (See Figure 2-36.)
11. Using sweep times and function generator frequencies in Table 2-23, check sweep time accuracy for sweep times <20 ms by the procedure of step 10.

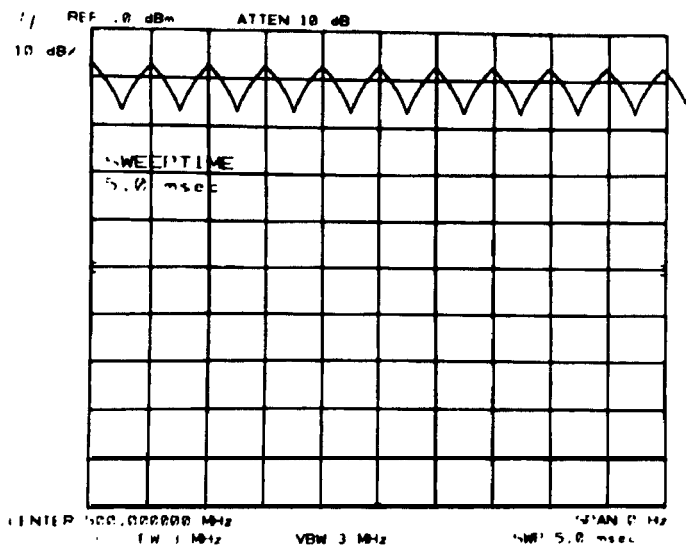

Figure 2-36. Fast Sweep Time Measurement (<20 ms)

21. Fast Sweep Time Accuracy Test (<20 ms)

Table 2-23. Fast Sweep Time Accuracy (<20 ms)

[SWEEP TIME]	Function Generator Frequency (kHz)	Sweep Time Error (divisions)
5 ms	2.00 ± 0.02	
2 ms	5.00 ± 0.05	
1 ms	10.0 ± 0.1	
200 μs	50.0 ± 0.5	
100 μs	100 ± 1	

22. Frequency Reference Error Test

Related Adjustment 10 MHz Standard Adjustment

Specification Aging Rate: $<1 \times 10^{-9}/\text{day}$ and $<2.5 \times 10^{-7}$ year; attained after 30 days warm-up from cold start at 25°C.
 Temperature Stability: $<7 \times 10^{-9}0^\circ$ to 55°C
 Frequency is within 1×10^{-8} of final stabilized frequency within 30 minutes.

Description The frequency of the spectrum analyzer time base oscillator is measured directly using a frequency counter locked to a frequency reference which has an aging rate less than one-tenth that of the time base specification. After a 30-day warm-up period, a frequency measurement is made. The analyzer is left undisturbed for a 24-hour period and a second reading is taken. The frequency change over this 24-hour period must be less than one part in 10^9 .

Note

This test requires that the spectrum analyzer be turned on (not in STANDBY) for a period of 30 days to ensure that the frequency reference attains its specified aging rate. However, after the aging rate is attained, the frequency reference typically attains its aging rate again in 72 hours of operation after being off for a period not exceeding 24 hours.

Because the frequency reference is sensitive to shock and vibration, care must be taken not to disturb the spectrum analyzer during the 24 hour period in which the frequency measurement is made.

The frequency reference should remain within its attained aging rate if: the instrument is left on; the instrument orientation with respect to the earth's magnetic field is maintained; and the instrument does not sustain any mechanical shock. Frequency changes due to orientation with respect to the earth's magnetic field and altitude changes will usually be nullified when the instrument is returned to its original position. Frequency changes due to mechanical shock will usually appear as a fixed frequency error.

The frequency reference is also sensitive to temperature changes; for this reason, the ambient temperature near the instrument at the first measurement time and the ambient temperature at the second measurement time should not differ by more than 1°C. Placing the spectrum analyzer in STANDBY turns the instrument off while continuing to provide power for the frequency reference oven, which minimizes warm up time. However, the spectrum analyzer must be ON to allow the frequency reference to attain its specified aging rate.

22. Frequency Reference Error Test

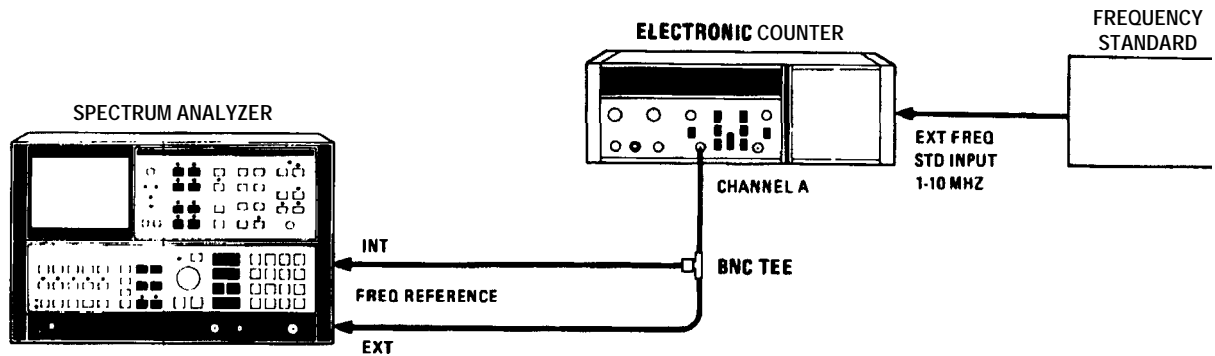

Figure 2-37. Frequency Reference Test Setup

Equipment	Electronic Counter	HP 5345A
	1, 2, 5, or 10 MHz Frequency Reference with again rate $<1 \times 10^{-10}/\text{day}$	HP 5061A
	BNC Tee	1250-0781

Procedure

1. Allow analyzer to warm up at 25°C ambient temperature for a period of 30 days.
2. Set controls of electronic counter as follows:

FUNCTION	FREQ A
DISPLAY POSITION	AUTO
GATE TIME	100 S
CHANNEL A Input Impedance	50
CHANNEL A ATTN	x1
CHANNEL A Coupling	AC
CHANNEL A LEVEL	midrange

3. Connect equipment as shown in Figure 2-37.
4. Record the frequency of the analyzer time base as measured by the counter:

Frequency: 10. M H z
 Date: _____ Time: _____
 Ambient Temperature: _____

5. Allow the analyzer to remain undisturbed for 24 hours, then note the time base frequency again:

Frequency: 10. M H z
 Date: _____ Time: _____
 Ambient Temperature: _____

Note

If the ambient temperatures recorded in steps 4 and 5 differ by more than 1°C, the frequency measurements may be invalid.

6. The difference in frequency between the two measurements should be <1 part in 10^9 (<0.01 Hz at 10 MHz).

H z

Table 2-24.
Performance Test
Record

Hewlett-Packard Company	Tested by _____
Model HP 8566B	Report No. _____
Serial No. _____	Date _____
IF-Display Section _____	
RF Section _____	

Test 1. Center Frequency Readout Accuracy

Step 8. CENTER Readout

Synthesized Sweeper Frequency	(FREQUENCY SPAN)	(CENTER FREQUENCY)	Center Frequency Readout		
			Min	Actual	Max
2 GHz	1 MHz	2 GHz	1.999 98 GHz		2.000 02 GHz
2 GHz	10 MHz	2 GHz	1.999 7 GHz		2.000 3 GHz
2 GHz	100 MHz	2 GHz	1.998 GHz		2.002 GHz
2 GHz	1 GHz	2 GHz	1.98 GHz		2.02 GHz
3 GHz	1 MHz	3 GHz	2.999 98 GHz		3.000 02 GHz
3 GHz	10 MHz	3 GHz	2.999 7 GHz		3.000 3 GHz
3 GHz	100 MHz	3 GHz	2.998 GHz		3.002 GHz
3 GHz	1 GHz	3 GHz	2.98 GHz		3.02 GHz
6 GHz	1 MHz	6 GHz	5.999 98 GHz		6.000 02 GHz
6 GHz	10 MHz	6 GHz	5.999 8 GHz		6.000 2 GHz
6 GHz	100 MHz	6 GHz	5.998 GHz		6.002 GHz
6 GHz	1 GHz	6 GHz	5.98 GHz		6.02 GHz
9 GHz	1 MHz	9 GHz	8.999 98 GHz		9.000 02 GHz
9 GHz	10 MHz	9 GHz	8.999 8 GHz		9.000 2 GHz
9 GHz	100 MHz	9 GHz	8.998 GHz		9.002 GHz
9 GHz	1 GHz	9 GHz	8.98 GHz		9.02 GHz
9 GHz	10 GHz	9 GHz	8.8 GHz		9.2 GHz
12 GHz	1 MHz	12 GHz	11.999 98 GHz		12.000 02 GHz
12 GHz	10 MHz	12 GHz	11.999 8 GHz		12.000 2 GHz
12 GHz	100 MHz	12 GHz	11.998 GHz		12.002 GHz
12 GHz	1 GHz	12 GHz	11.98 GHz		12.02 GHz
12 GHz	10 GHz	12 GHz	11.8 GHz		12.2 GHz
15 GHz	1 MHz	15 GHz	14.999 98 GHz		15.000 02 GHz
15 GHz	10 MHz	15 GHz	14.999 8 GHz		15.000 2 GHz
15 GHz	100 MHz	15 GHz	14.998 GHz		15.002 GHz
15 GHz	1 GHz	15 GHz	14.98 GHz		15.02 GHz
15 GHz	10 GHz	15 GHz	14.8 GHz		15.2 GHz
18 GHz	1 MHz	18 GHz	17.999 98 GHz		18.000 02 GHz
18 GHz	10 MHz	18 GHz	17.999 8 GHz		18.000 2 GHz
18 GHz	100 MHz	18 GHz	17.998 GHz		18.002 GHz
18 GHz	1 GHz	18 GHz	17.98 GHz		18.02 GHz
18 GHz	10 GHz	18 GHz	17.8 GHz		18.2 GHz

Test 2. Frequency Span Accuracy Test

Step 7. Narrow Span Accuracy

Spectrum Analyzer		Frequency Synthesizer		MARKER A Frequency		
(FREQUENCY SPAN)	Low (Hz)	High (Hz)	Min	Actual	Max	
20 kHz	39,992,000	40,008,000	15.84 kHz		16.16 kHz	
50 kHz	39,980,000	40,020,000	39.60 kHz		40.40 kHz	
150 kHz	39,940,000	40,060,000	118.80 kHz		121.20 kHz	
200 kHz	39,920,000	40,080,000	158.4 kHz		161.6 kHz	
1 MHz	39,600,000	40,400,000	792.00 kHz		808.00 kHz	
2 MHz	39,200,000	40,800,000	1.584 MHz		1.616 MHz	
6 MHz	37,600,000	42,400,000	4.656 MHz		4.944 MHz	
10 MHz	36,000,000	44,000,000	7.76 MHz		8.240 MHz	
50 MHz	20,000,000	60,000,000	38.80 MHz		41.2 MHz	

Step 18. Wide Span Accuracy

Spectrum Analyzer		Synthesized Sweeper		MARKER A Frequency		
(CENTER FREQUENCY)	(FREQUENCY SPAN)	Low (GHz)	High (GHz)	Min	Actual	Max
4 GHz	500 MHz	3.800	4.200	388 MHz		412 MHz
10 GHz	500 MHz	9.800	10.200	388 MHz		412 MHz
15 GHz	500 MHz	14.800	15.200	388 MHz		412 MHz
20 GHz	500 MHz	19.800	20.200	388 MHz		412 MHz
4 GHz	1 GHz	3.600	4.400	776 MHz		824 MHz
10 GHz	1 GHz	9.600	10.400	776 MHz		824 MHz
15 GHz	1 GHz	14.600	15.400	776 MHz		824 MHz
20 GHz	1 GHz	19.600	20.400	776 MHz		824 MHz
10 GHz	5 GHz	8.000	12.000	3.88 GHz		4.12 GHz
15 GHz	5 GHz	13.000	17.000	3.88 GHz		4.12 GHz
18 GHz	5 GHz	16.000	20.000	3.88 GHz		4.12 GHz
10 GHz	10 GHz	6.000	14.000	7.76 GHz		8.24 GHz
15 GHz	10 GHz	11.000	19.000	7.76 GHz		8.24 GHz

**Test 3. Resolution
Bandwidth
Accuracy Test**

Step 8. Bandwidth Accuracy

RES BW	FREQUENCY SPAN	MARKER Δ Readout of 3 dB Bandwidth		
		Min	Actual	Max
3 MHz	5 MHz	2.400 MHz		3.600 MHz
1 MHz	2 MHz	900 kHz		1.100 MHz
300 kHz	500 kHz	270.0 kHz		330.0 kHz
100 kHz	200 kHz	90.0 kHz		110.0 kHz
30 kHz	50 kHz	27.00 kHz		33.00 kHz
10 kHz	20 kHz	9.00 kHz		11.00 kHz
3 kHz	5 kHz	2.700 kHz		3.300 kHz
1 kHz	2 kHz	800 Hz		1.200 kHz
300 Hz	500 Hz	240 Hz		360 Hz
100 Hz	200 Hz	80 Hz		120 Hz
30 Hz	100 Hz	24.0 Hz		36.0 Hz
10 Hz	100 Hz	8.0 Hz		12.0 Hz

Test 4. Resolution Bandwidth Selectivity

Step 9. Resolution Bandwidth Selectivity

Spectrum Analyzer			Measured 60 dB Bandwidth	Measured 3 dB Bandwidth	Bandwidth Selectivity (60 dB BW ÷ 3dB BW)	Maximum Selectivity Ratio
RES BW	FREQUENCY SPAN	VIDEO BW				
3 MHz	20 MHz	100 Hz				15:1
1 MHz	15 MHz	300 Hz				15:1
300 kHz	5 MHz	AUTO				15:1
100 kHz	2 MHz	AUTO				15:1
30 kHz	500 kHz	AUTO				13:1
10 kHz	200 kHz	AUTO				13:1
3 kHz	50 kHz	AUTO				11:1
1 kHz	10 kHz	AUTO				11:1
300 Hz	5 kHz	AUTO				11:1
100 Hz	2 kHz	AUTO				11:1
30 Hz	500 Hz	AUTO				11:1
10 Hz	100 HZ	AUTO		30 dB points separated by <100 Hz		

**Test 5. Resolution
Bandwidth
Switching
Uncertainty**

Step 5. Bandwidth Switching Uncertainty

RES BW)	FREQUENCY SPAN)	Deviation (MKR A Readout, dB)	Allowable Deviation (dB)
1 MHz	5 MHz	0 (ref)	3 (ref)
3 MHz	5 MHz		f1.00
300 kHz	5 MHz		f0.50
100 kHz	500 kHz		f0.50
30 kHz	500 kHz		±0.50
10 kHz	50 kHz		±0.50
3 kHz	50 kHz		f0.50
1 kHz	10 kHz		f0.50
300 Hz	1 kHz		f0.50
100 Hz	1 kHz		f0.50
30 Hz	200 Hz		±0.80
10 Hz	100 Hz		f2.00

**Test 6. Log Scale
Switching
Uncertainty Test**

Step 6. Log Scale Switching Uncertainty

SCALE (dB/DIV)	MKR Amplitude (dBm)	Deviation (dB)	Allowable Deviation (dB)
1	_____	0 (ref)	0 (ref)
2	_____		f0.5
5	_____		f0.5
10	_____		f0.5

Test 7. IF Gain Uncertainty

Step 12. IF Gain Uncertainty, 10 dB Steps

(REFERENCE LEVEL) (dBm)	Frequency Synthesizer Amplitude (dBm)	(VIDEO BW) (Hz)	Deviation (Marker A Amplitude (dB))
0	-2	100	0 (ref.)
-10	-12	100	
-20	-22	100	
-30	-32	100	
-40	-42	100	
-50	-52	100	
-60	-62	10	
-70	-72	10	
(SHIFT) (ENTER dB/DIV) ^a			
-80	-32	100	
-90	-42	100	
-100	-52	10	
-110	-62	10	
-120	-72	10	

Step 18. IF Gain Uncertainty, 2 dB Steps

(REFERENCE LEVEL) (dBm)	Frequency Synthesizer Amplitude (dBm)	Deviation (MARKER A Amplitude (dB))
-1.9	-3.9	0 (ref)
-3.9	-5.9	
-5.9	-7.9	
-7.9	-9.9	
-9.9	-11.9	

Test 7. IF Gain Uncertainty

Step 22. IF Gain Uncertainty, 0.1 dB Steps

[REFERENCE LEVEL] (dBm)	Frequency Synthesizer Amplitude (dBm)	Deviation (MKR A Amplitude (dB))
0.0	-2.00	0 (ref)
-0.1	-2.10	
-0.2	-2.20	
-0.3	-2.30	
-0.4	-2.40	
-0.5	-2.50	
-0.6	-2.60	
-0.7	-2.70	
-0.8	-2.80	
-0.9	-2.90	
-1.0	-3.00	
-1.1	-3.10	
-1.2	-3.20	
-1.3	-3.30	
-1.4	-3.40	
-1.5	-3.50	
-1.6	-3.60	
-1.7	-3.70	
-1.8	-3.80	
-1.9	-3.90	

Test 7. IF Gain Uncertainty

Steps 23 through 28.

Steps	Min	Measured	Max
23. Recorded deviations from step 12.			
Largest Positive 0 to -70 dBm			
Largest Negative 0 to -70 dBm			
Largest Positive -80 to -120 dBm			
Largest Negative -80 to -120 dBm			
24. Recorded deviation from steps 18 and 22.			
Largest Positive step 18			
Largest Negative step 18			
Largest Positive step 22			
Largest Negative step 22			
25.			
Sum of Positive Deviations of steps 23 and 24			0.6 dB
26.			
Sum of Negative Deviations of steps 23 and 24	-0.6 dB		
27.			
Sum of Positive Deviations of steps 23 and 24			1.0 dB
28.			
Sum of Positive Deviations of steps 23 and 24	-1.0 dB		

Test 8. Amplitude Fidelity

Step 6. Log Scale Fidelity

Frequency Synthesizer Amplitude (dBm)	1 Calibrated Amplitude Step	2 MARKER A Amplitude (dB)	Fidelity Error (Column 2 - Column 1) (dB)	Cumulative Error 0 to 80 dB (dB)	Cumulative Error 0 to 90 dB (dB)
+ 10	0 (ref)	0 (ref)	0 (ref)		
0	-10	_____	_____		
-10	-20	_____	_____		
-20	-30	_____	_____		
-30	-40	_____	_____		
-40	-50	_____	_____		
-50	-60	_____	_____		
-60	-70	_____	_____		
-70	-80	_____	_____		
-80	-90	_____	_____		

Step 14. Linear Scale Fidelity

Frequency Synthesizer Amplitude (dBm)	MARKER A Amplitude (dB)	Allowable Range (±3% of Reference Level) (dB)	
		Min	Max
0		-10.87	-9.21
-10		-23.10	-17.72

**Test 9. Calibrator
Amplitude
Accuracy**

Step 2. CAL OUTPUT Level

	Min	Measured	Max
Cal OUTPUT level	- 10.30 dB	_____	I-9.70 dB

Test 10. Frequency Response Test

Step 12

	Min	Measured	Max
Deviation 1 kHz to 100 kHz			1.2 dB

Step 18

Signal Level	Min	Measured	Max
100 Hz	-1.4 dB		-2.6 dB
200 Hz	-1.4 dB		-2.6 dB
300 Hz	-1.4 dB		-2.6 dB
400 Hz	-1.4 dB		-2.6 dB
500 Hz	-1.4 dB		-2.6 dB
600 Hz	-1.4 dB		-2.6 dB
700 Hz	-1.4 dB		-2.6 dB
800 Hz	-1.4 dB		-2.6 dB
900 Hz	-1.4 dB		-2.6 dB
1 kHz	-1.4 dB		-2.6 dB
Deviation 100 Hz to 1 kHz			1.2 dB

Steps 27, 35 and 49. 100 Hz to 2.5 GHz Frequency Rand

Spectrum Analyzer		Frequency Synthesizer		Synthesized Sweeper		Trace Limits			
				Sweep Time 150 s		Spec f0.6 dB			
START FREQ	STOP FREQ	Freq	Sweep Width	START FREQ	STOP FREQ	Minimum		Maximum	
						Amp	Freq	Amp	Freq
100 kHz	4 MHz	2,000,100 Hz	3,998,000 Hz						
4 MHz	60 MHz	30050 kHz	59900 kHz						
60 MHz	2.5 GHz	-	-	60 MHz	2.5 GHz				

Test 10. Frequency Response Test

Table 2-24. Frequency Response (Flatness)

1 Frequency Band	2 Spectrum Analyzer and Synthesized Sweeper		3 Cal Frequency Power Sensor	4 Trace Limits				6 Flatness (dB)
				Minimum		Maximum		
	START FREQ	STOP FREQ		Amplitude (dBm)	Frequency	Amplitude (dBm)	Frequency	
MHz - 2.5 GHz Spec	60 MHz	2.5 GHz	100 MHz					1.20
				-11.20		-8.80		
2 - 5.8 GHz Spec	2 GHz 3.9 GHz	3.9 GHz 5.8 GHz	3 GHz 5 GHz					3.40
				-12.30		-7.70		
1.8 - 12.5 GHz Spec	5.8 GHz 9.15 GHz	9.15 GHz 12.5 GHz	7 GHz 11 GHz					3.40
				-12.30		-7.70		
2.5 - 18.6 GHz Spec	12.5 GHz 15.55 GHz	15.55 GHz 18.6 GHz	14 GHz 17 GHz					4.40
				-12.80		-7.20		
18.6 - 20 GHz Spec	18.6 GHz	20 GHz	19 GHz					4.40
20 - 22 GHz Spec	20 GHz	22 GHz	21 GHz					6.00
Cumulative Flatness (dB)								
100 Hz to 20 GHz								
Specification: 4.40 dB								
100 Hz to 22 GHz								
Specification: 6.00 dB								

Test 11. Sweep Time Accuracy

Step 6. Sweep Time Accuracy, Sweep Times ≥ 20 ms

[SWEEP TIME]	Sweep Time		
	Min	Measured	Max
20 ms	18 ms		22 ms
30 ms	27 ms		33 ms
50 ms	45 ms		55 ms
70 ms	63 ms		77 ms
90 ms	81 ms		99 ms
110 ms	99 ms		121 ms
170 ms	153 ms		187 ms
200 ms	180 ms		220 ms
2 s	1.8 s		2.2 s

Step 12. Sweep Time Accuracy

[SWEEP TIME]	MARKER A Time		
	Min	Measured	Max
20 s	3.6 s		4.4 s
200 s	36 ms		44 ms
240 s	33.6 ms		62.4 ms

Test 12. Noise Sidebands Test

Steps	Min	Measured	Max
11. Noise Sideband Level 320 Hz offset			-80 dBc
16. Noise Sideband Level 1 kHz offset			-85 dBc
21. Noise Sideband Level 10 kHz offset			-90 dBc
26. Noise Sideband Level 100 kHz offset			-105 dBc

**Test 13.
Line-Related
Sidebands**

Steps	Min	Measured	Max
9. Line-Related Sidebands Levels for 100 MHz signal			
Largest level <360 Hz away from signal		____dB a t H z	- 7 0 dB
Largest level 360 Hz to 600 Hz away from signal		____dB a t H z	-75 dBm
15. Line-Related Sidebands Levels for 2.4 GHz signal			
Largest level <360 Hz away from signal		____dB a t H z	-60 dBm
20. Line-Related Sidebands Levels for 2.6 GHz signal			
Largest level <360 Hz away from signal		____dB a t H z	- 6 0 dB
25. Line-Related Sidebands Levels for 5.7 GHz signal			
Largest level <360 Hz away from signal		____dB a t H z	- 6 0 dB
Option 400			
13. Line-Related Sidebands Levels for 5.7 GHz signal			
Largest level <2 kHz away from signal		____dB a t H z	- 5 5 dB
Largest level 2 kHz to 5.5 kHz away from signal		____dB a t - H z	- 6 5 dB

Test 14. Average Noise Level

Steps	Min	Measured	Max
8 and 10. Marker Amplitude Readout			
100 Hz			-95 dBm
51 kHz			-112 dBm

Step 11. Average Noise Level

CENTER FREQUENCY	MARKER Amplitude (dBm)	Maximum Amplitude (dBm)
2.0 MHz		-134
1.001 GHz		-134
2.499 GHz		-134
2.510 GHz		-132
5.799 GHz		-132
5.810 GHz		-125
12.499 GHz		-125
12.510 GHz		-119
18.59 GHz		-119
18.61 GHz		-114
20.0 GHz		-114

Test 15. Residual Responses

Steps	Min	Measured	Max
8. Residual Responses 0 Hz to 1.5 GHz Largest Residual Level		____dBm a t H z	-100 dBm
11. Residual Responses 1.4 to 2.5 GHz Largest Residual Level		____dBm a t H z	-100 dBm
13. Residual Responses 2.4 to 5.8 GHz Largest Residual Level		____dBm a t H z	-100 dBm
15. Residual Responses 5.7 to 6.7 GHz Largest Residual Level		____dBm a t H z	-95 dBm
16. Residual Responses 6.690 to 11.650 GHz Largest Residual Level		____dBm a t H z	-95 dBm
18. Residual Responses 11.6 to 12.5 GHz Largest Residual Level		____dBm a t H z	-95 dBm
21. Residual Responses 12.4 to 18.6 GHz Largest Residual Level		____dBm a t H z	-85 dBm
24. Residual Responses 18.5 to 22 GHz Largest Residual Level		____dBm a t H z	-80 dBm

Test 16. Harmonic And Intermodulation Distortion

Steps	Min	Measured	Max
8. Second Harmonic Level of 230 MHz			-80 dBc
15. Second Harmonic Level of 800 MHz			-70 dBc
25. Second Harmonic Level of 7200 MHz			-100 dBc
40. TO1 for signals of 2099.5 and 2100.5 MHz	+ 7 dBm		
54. TO1 for signals of 3999.5 and 4000.5 MHz	+ 7 dBm		
55. TO1 for signals of 8999.5 and 9000.5 MHz	+ 5 dBm		
TO1 for signals of 13999.500 and 14000.499 MHz	+ 5 dBm		

**Test 17. Image,
Multiple, and
Out-of-Band
Responses**

Step 8. Image and Out-of-Rand Response

Spectrum Analyzer <small>(CENTER FREQUENCY)</small> (GHz)	Synthesized Sweeper Frequency (MHz)	Displayed Spurious Amplitude	
		Measured (dBc)	Maximum (dBc)
3	3642.800		-70
	6321.400		-60
	6964.200		-60
6	2517.900		-60
	3160.700		-60
	5357.200		-70
9	4017.900		-60
	4660.700		-60
	8357.200		-70
	12696.500		-60
	13339.300		-60
12	5517.900		-60
	6160.700		-60
	11357.200		-70
	17196.500		-60
	17839.300		-60
15	4571.500		-60
	5214.300		-60
	9464.300		-60
	10107.100		-60
	14357.200		-70
17	5238.100		-60
	5880.900		-60
	10797.700		-60
	11440.500		-60
	16357.200		-70

Test 17. Image, Multiple, and Out-of-Rand Responses

Step 8. Image and Out-of-Rand Response (continued)

Spectrum Analyzer [CENTER FREQUENCY] (GHz)	Synthesized Sweeper Frequency (MHz)	Displayed Spurious Amplitude	
		Measured (dBc)	Maximum (dBc)
19	4348.300		-60
	4991.100		-60
	9017.900		-60
	9660.700		-60
	13687.600		-60
	14330.400		-60
	18357.200		-60
21	4848.300		-60
	5491.100		-60
	10017.900		-60
	10660.700		-60
	15187.600		-60
	15830.400		-60
	20357.200		-50

Step 17. Multiple Responses

Synthesized Sweeper Frequency (MHz)	[CENTER FREQUENCY] (Multiple Response) (GHz)	Displayed Spurious Amplitude	
		Measured (dBc)	Maximum (dB)
5700.000	2.68930		-70
6000.000	1.18930		-50
12000.000	8.107133		-70
	8.535667		-70
13000.000	1.06790		-45
	1.9107		-45
	0.53395		-45
15000.000	10.107133		-60
	10.535667		-60

**Test 18. Gain
Compression**

Steps	Min	Measured	Max
14. Gain Compression for input -10 to 0 dBm at 2 GHz	-1.0 dB		
27. Gain Compression for input -15 to -5 dBm at 3 GHz	-1.0 dB		
36. Gain Compression for input -15 to -5 dBm at 9 GHz	-1.0 dB		

**Test 19. 1st LO
Output Amplitude**

Steps	Min	Measured	Max
4. 1st LO OUTPUT Level	+ 5 dBm		

**Test 20. Sweep +
Tune Out Accuracy**

Step 3. Sweep + Tune Out Accuracy

CENTER FREQUENCY	Voltmeter Reading (Volts)		
	Min	Actual	Max
0 Hz	-0.010		+ 0.010
1 MHz	-0.011		+ 0.009
12 MHz	-0.022		-0.002
130 MHz	-0.143		-0.117
670 MHz	-0.693		-0.647
1.3 GHz	-1.336		-1.264
5.7 GHz	-5.824		-5.576
12.5 GHz	-12.760		-12.240
18.6 GHz	- 18.982		-18.218
22 GHz	-22.450		-21.550

Test 21. Fast Sweep Time Accuracy (< 20 ms)

Step 10. Fast Sweep Time Accuracy (<20 ms)

(SWEEP TIME)	Function Generator Frequency (kHz)	Sweep Time Error (divisions)
5 ms	2.00 f0.02	
2 ms	5.00 f0.05	
1 ms	10.0 ±0.1	
200 μs	50.0 f0.5	
100 μs	100 ±1	

Test 22. Frequency Reference Error Test

Steps	Min	Measured	Max
4. Initial Frequency		1 0 . M H z	
5. Frequency after 24 hours		1 0 . M H z	
6. Difference between 4 and 5		H z	0.01 Hz

Adjustments

Introduction

The procedures in this section are for the adjustment of the instrument's electrical performance characteristics.

Warning

The procedures require access to the interior of the instrument and therefore should only be performed by qualified service personnel. Refer to *Safety Considerations* in this introduction.

1. Low-Voltage Power Supply Adjustments	3-25
2. High-Voltage Adjustment (SN 3001A and Below)	3-31
2. High-Voltage Adjustment (SN 3004A and Above)	3-41
3. Preliminary Display Adjustments (SN 3001A and Below)	3-48
3. Preliminary Display Adjustments (SN 3004A and Above)	3-56
4. Final Display Adjustments (SN 3001A and Below)	3-64
4. Final Display Adjustments (SN 3004A and Above)	3-66
5. Log Amplifier Adjustments	3-70
6. Video Processor Adjustments	3-75
7. 3 MHz Bandwidth Filter Adjustments	3-78
8. 21.4 MHz Bandwidth Filter Adjustments	3-84
9. 3 dB Bandwidth Adjustments	3-92
10. Step Gain and 18.4 MHz Local Oscillator Adjustments	3-96
11. Down/Up Converter Adjustments	3-102
12. 10 MHz Standard Adjustment (SN 2637A and Below)	3-106
12. 10 MHz Standard Adjustment (SN 2728A and Above)	3-110
13. Sweep, DAC, and Main Coil Driver Adjustments	3-114
14. 100 MHz VCXO Adjustments	3-126
15. M/N Loop Adjustments	3-133
16. YTO Loop Adjustments	3-137
17. 20/30 Loop Phase Lock Adjustments	3-148
18. RF Module Phase Lock Adjustments	3-161
19. CAL Output Adjustment	3-167
20. Last Converter Adjustments	3-171
21. Frequency Response Adjustments	3-176
22. Analog-To-Digital Converter Adjustments	3-207
23. Track and Hold Adjustments	3-210
24. Digital Storage Display Adjustments	3-213

The adjustment procedures should not be performed as routine maintenance, but only when Performance Tests cannot meet specifications. Before attempting any adjustment, allow the instrument to warm up for one hour. **Table 3-1** is a cross reference of Function Adjusted to the related Adjustment procedure. **Table 3-2** lists all adjustable components by name, reference designator, and function.

Safety Considerations

Although this instrument has been designed in accordance with international safety standards, this manual contains information, cautions, and warnings which must be followed to ensure safe operations and to retain the instrument in safe condition. Service and adjustments should be performed only by qualified service personnel.

Warning

Adjustments in this section are performed with power supplied to the instrument while protective covers are removed. There are voltages at many points in the instrument which can, if contacted, cause personal injury. Be extremely careful. Adjustment should be performed only by trained service personnel.

Power is still applied to this instrument with the LINE switch in STANDBY. There is no OFF position on the LINE switch. Before removing or installing any assembly or printed circuit board, remove the power cord from the rear of both instruments and wait for the MAINS indicators (red LEDs) to go completely out.

Capacitors inside the instrument may still be charged even if the instrument has been disconnected from its source of power.

Use a non-metallic tuning tool whenever possible.

Equipment Required

The equipment required for the adjustment procedures is listed in Table I-1, Recommended Test Equipment, at the beginning of this manual. If the test equipment recommended is not available, substitutions may be used if they meet the "Critical Specifications" listed in the table. The test setup used for an adjustment procedure is referenced in each procedure.

Adjustment Tools

For adjustments requiring a non-metallic tuning tool, use fiber tuning tool HP Part Number 8710-0033. In situations not requiring non-metallic tuning tools, an ordinary small screwdriver or other suitable tool is sufficient. However, it is recommended that you use a non-metallic adjustment tool whenever possible. Never try to force any adjustment control in the analyzer. This is especially critical when tuning variable slug-tuned inductors and variable capacitors.

Factory-Selected Components

Factory-selected components are identified with an asterisk (*) on the schematic diagram. For most components, the range of their values and functions are listed in **Table 3-3, Factory-Selected Components**. Part numbers for selected values are located in **Table 3-4 through Table 3-6, Standard Value Replacement components**.

Related Adjustments

Any adjustments which interact with, or are related to, other adjustments are indicated in the adjustments procedures. It is important that adjustments so noted are performed in the order indicated to ensure that the instrument meets specifications.

Location of Test Points and Adjustments

Illustrations showing the locations of assemblies containing adjustments, and the location of those adjustments within the assemblies, are contained within the adjustment procedures to which they apply. Major assembly and component location illustrations are located at the rear of this manual.

Table 3-1. Adjustment Cross Reference

Function Adjusted	Test Number	Adjustment Procedure
Low Voltage	1	Low Voltage Power Supply Adjustments
High Voltage	2	High Voltage Adjustment
CRT Display (Standard)	3	Preliminary Display Adjustment
	4	Final Display Adjustments
CRT Display (Digital Storage)	24	Digital Storage Display Adjustments
IF Gains	5	Log Amplifier Adjustments
	10	Step Gain and 18.4 MHz Local Oscillator Adjustments
Log Scales	6	Video Processor Adjustments
Bandwidth Amplitudes	7	3 MHz Bandwidth Filter Adjustments
	8	21.4 MHz Bandwidth Filter Adjustments
	11	Down/Up Converter Adjustments
3 dB Bandwidth	9	3 dB Bandwidth Adjustments
10 MHz Internal Time Base	12	10 MHz Standard Adjustment
CAL OUTPUT Level	19	CAL Output Adjustments
Frequency Span	13	Sweep, DAC, and Main Coil Driver Adjustments
START and STOP Frequency	13	Sweep, DAC, and Main Coil Driver Adjustments
Sweep Times	13	Sweep, DAC, and Main Coil Driver Adjustments
Frequency Tuning	13	Sweep, DAC, and Main Coil Driver Adjustments
	14	100 MHz VCXO Adjustments
	15	MM Loop Adjustments
Phase Lock Loops	18	RF Module Phase Lock Adjustments
	16	YTO Loop Adjustments
	17	20/30 Loop Phase Lock Adjustments
RF Signal Conversion and RF Gains	20	Last Converter Adjustments
	21	Frequency Response Adjustments
Frequency Response	21	Frequency Response Adjustments
Digital Storage Video Processing	22	Analog-to-Digital Converter Adjustments
	23	Track and Hold Adjustments

Table 3-2. Adjustable Components

Reference Designator	Adjustment Name	Adjustment Number	Adjustment Function
A1A2C308	C307	3	Adjusts rise and fall times of Z axis amplifier pulse.
A1A2R308	ZHF GAIN	3	Adjusts rise and fall times of Z axis amplifier pulse.
A1A2R319	INT GAIN	3	Sets adjustment range of front-panel INTENSITY control.
A1A2R409	FOCUS COMP	3	Corrects focus for beam intensity.
A1A2R426	T/B FOC		Magnitude of top/bottom focus correction.
A1A2R427	T/B CTR		Centering of top/bottom focus correction.
A1A2R437	R/L FOC		Magnitude of right/left focus correction.
A1A2R440	R/L CTR		Centering of right/left focus correction.
A1A2R512	ORTHO	3	Sets orthogonality of CRT.
A1A2R513	3 D	3	Adjusts spot size.
A1A2R515	INTENSITY LIMIT	3	Sets adjustment range of front-panel INTENSITY control.
A1A2R517	ASTIG	3	Adjusts astigmatism of CRT.
A1A3R14	FOCUS LIMIT	3	Coarse adjusts CRT focus.
A1A4C204	C204	3	Adjusts rise and fall times of X deflection amplifier pulse.
A1A4C209	C209	3	Adjusts rise and fall times of X deflection amplifier pulse.
A1A4R227	X POSN	3	Adjusts horizontal position of trace.
A1A4R219	X GAIN	3,4	Adjusts horizontal gain of trace.
A1A4R217	XHF GAIN	3	Adjusts rise and fall times of X deflection amplifier pulse.
A1A5C104	C104	3	Adjusts rise and fall times of Y deflection amplifier pulse.
A1A5C109	C109	3	Adjusts rise and fall times of Y deflection amplifier pulse.
A1A5R127	Y POSN	3,4	Adjusts vertical position of trace.
A1A5R120	Y GAIN	3,4	Adjusts vertical gain of trace.
A1A5R117	YHF GAIN	3,4	Adjusts rise and fall times of Y deflection amplifier pulse.
A1A6R9	+ 15 ADJ	1	Adjusts + 15 V dc supply voltage.
A1A6R103	HV ADJUST	2	Adjusts CRT high voltage.
For Serial Prefix 3001A and below, see back of table for exceptions to A1A2 through A1A6.			

Table 3-2. Adjustable Components (continued)

Reference Designator	Adjustment Name	Adjustment Number	Adjustment Function
A3A1R34	SWEEP OFFSET	25	Adjusts digital sweep to begin at left edge of graticule.
A3A2R12	LL THRESH	25	Adjusts point at which graticule lines switch from short to long lines.
A3A2R50	X S&H	25	Adjusts horizontal sample and hold pulse.
A3A2R51	Y S&H	25	Adjusts vertical sample and hold pulse.
A3A3R1	X EXP	25	Adjusts horizontal position of annotation.
A3A3R2	Y EXP	25	Adjusts vertical position of annotation.
A3A3R4	X GAIN	25	Adjusts horizontal gain of graticule lines.
A3A3R5	Y GAIN	25	Adjusts vertical gain of graticule lines.
A3A3R6	XLL	25	Adjusts horizontal long lines on graticule information.
A3A3R7	XSL	25	Adjusts horizontal short lines on graticule information.
A3A3R8	YSL	25	Adjusts vertical short lines on graticule information.
A3A3R9	YLL	25	Adjusts vertical long lines on graticule information.
A3A3R43	YOS	25	Adjusts bottom line of graticule to align with fast sweep signal.
A3A8R5	GAIN	23	Adjusts high end of digitized sweep.
A3A8R6	OFFS	23	Adjusts low end of digitized sweep.
A3A9R36	OFS NEG	24	Adjusts offset of negative peak detect mode.
A3A9R39	GPOS	24	Adjusts gain for positive peak detect mode.
A3A9R44	OFS POS	24	Adjusts offset of positive peak detect mode.
A3A9R52	GNEG	24	Adjusts gain for negative peak detect mode.
A3A9R57	T/H GAIN	24	Adjusts overall gain of track and hold.
A3A9R59	(T/H) OFS	24	Adjusts overall offset of track and hold.
A4A1R2	LG OS	6	Adjusts linear gain offsets.
A4A1R14	OS	6	Adjusts video processor offset.
A4A1R32	ZERO	6	Adjusts low end of video processor sweep.
A4A1R36	FS	6	Adjusts high end of video processor sweep.
A4A2R14	LG20	5	Adjusts 20 dB linear gain step.
A4A2R79	ZERO	5	Adjusts log amplifier offset.
A4A2R61	-12 VTV	5	Adjusts log amplifier tuning voltage.
A4A3C55	CTR	5	Adjusts log amplifier center to IF
A4A3R67	AMPTD	5	Adjusts amplitude of log amplifier bandpass filter.
A4A3R83	LG10	5	Adjusts 10 dB linear gain step.

Table 3-2. Adjustable Components (continued)

Reference Designator	Adjustment Name	Adjustment Number	Adjustment Function
A4A4C9	SYM	8	Centers A4A4 bandwidth filter crystal pole #1 symmetry.
A4A4C19	LC CTR	8	Centers A4A4 bandwidth filter LC pole #1.
A4A4C20	CTR	8	Centers A4A4 bandwidth filter crystal pole #1.
A4A4C39	SYM	8	Adjusts A4A4 bandwidth filter crystal pole #2 symmetry.
A4A4C41	LC DIP	8	Dips A4A4 bandwidth filter LC pole #1.
A4A4C43	LC DIP	8	Dips A4A4 bandwidth filter LC pole #2.
A4A4C65	SYM	8	Adjusts A4A4 bandwidth filter crystal pole #3 symmetry.
A4A4C67	LC CTR	8	Centers A4A4 bandwidth filter LC pole #2.
A4A4C73	CTR	8	Centers A4A4 bandwidth filter crystal pole #3.
A4A4C74	CTR	8	Centers A4A4 bandwidth filter crystal pole #2.
A4A4R43	LC	8	Adjusts LC filter amplitudes.
A4A4R49	XTAL	8	Adjusts crystal filter amplitudes.
A4A5C10	FREQ ZERO COARSE	10	Coarse-adjusts 18.4 MHz Local Oscillator to set adjustment range of front-panel FREQ ZERO control.
A4A5R2	+ 10V ADJ	10	Adjusts + 10V temperature compensation supply.
A4A5R32	SG10	10	Adjusts 10 dB step gain.
A4A5R33	CAL	10	Adjusts IF gain.
A4A5R44	SG20-1	10	Adjusts first 20 dB step gain.
A4A5R51	VR	10	Adjusts variable step gain.
A4A5R54	SG20-2	10	Adjusts second 20 dB step gain.
A4A6A1C31	18.4 MHz NULL	10	Nulls 18.4 MHz local oscillator signal.
A4A6A1R29	WIDE GAIN	11	Adjusts gain of down/up converter.
A4A7C6	SYM	7	Adjusts 3 MHz bandwidth filter pole #1 symmetry.
A4A7C7	CTR	7	Centers 3 MHz bandwidth filter pole #1.
A4A7C13	PK	7	Peaks 3 MHz bandwidth filter pole #2.
A4A7C14	SYM	7	Adjusts 3 MHz bandwidth filter pole #2 symmetry.
A4A7C15	CTR	7	Centers 3 MHz bandwidth filter pole #2.
A4A7C22	PK	7	Peaks 3 MHz bandwidth filter pole #3.
A4A7C23	SYM	7	Adjusts 3 MHz bandwidth filter pole #3 symmetry.
A4A7C24	CTR	7	Centers 3 MHz bandwidth filter pole #3.
A4A7C31	PK	7	Peaks 3 MHz bandwidth filter pole #4.
A4A7C32	SYM	7	Adjusts 3 MHz bandwidth filter pole #4 symmetry.
A4A7C33	CTR	7	Centers 3 MHz bandwidth filter pole #4.
A4A7C40	PK	7	Peaks 3 MHz bandwidth filter pole #5.
A4A7C41	SYM	7	Adjusts 3 MHz bandwidth filter pole #5 symmetry.

Table 3-2. Adjustable Components (continued)

Reference Designator	Adjustment Name	Adjustment Number	Adjustment Function
A4A7C42	CTR	7	Centers 3 MHz bandwidth filter pole #5.
A4A7R30	10 Hz AMPTD	7	Adjusts 3 MHz bandwidth filter 10 Hz bandwidth amplitude.
A4A7R41	10 Hz AMPTD	7	Adjusts 3 MHz bandwidth filter 10 Hz bandwidth amplitude.
A4A8C13	SYM	8	Adjusts A4A8 bandwidth filter crystal pole #1 symmetry.
A4A8C29	CTR	8	Centers A4A8 bandwidth filter crystal pole #1.
A4A8C32	LC CTR	8	Centers A4A8 bandwidth filter LC pole #1.
A4A8C42	SYM	8	Adjusts A4A8 bandwidth filter crystal pole #2 symmetry.
A4A8C44	CTR	8	Centers A4A8 bandwidth filter crystal pole #2.
A4A8C46	LC CTR	8	Centers A4A8 bandwidth filter LC pole #2.
A4A8C66	LC DIP	8	Dips A4A8 bandwidth filter LC pole #1.
A4A8C67	LC DIP	8	Dips A4A8 bandwidth filter LC pole #2.
A4A8R6	A20 dB	8	Adjusts attenuation of 21.4 MHz bandwidth filter 20 dB step.
A4A8R7	A10 dB	8	Adjusts attenuation of 21.4 MHz bandwidth filter 10 dB step.
A4A8R35	LC	8	Adjusts LC filter amplitudes.
A4A8R40	XTAL	8	Adjusts crystal filter amplitudes.
A4A9R60	3 MHz	9	Adjusts 3 MHz bandwidth.
A4A9R61	1 MHz	9	Adjusts 1 MHz bandwidth.
A4A9R62	300 kHz	9	Adjusts 300 kHz bandwidth.
A4A9R65	10 kHz	9	Adjusts 10 kHz bandwidth.
A4A9R66	3 kHz	9	Adjusts 3 kHz bandwidth.
A4A9R73	1 kHz	9	Adjusts 1 kHz bandwidth (Option 067).
A6A3A1C8	C8	20	Adjusts 321.4 MHz bandpass filter.
A6A3A1C9	C9	20	Adjusts 321.4 MHz bandpass filter.
A6A3A1C10	C10	20	Adjusts 321.4 MHz bandpass filter.
A6A3A1C11	C11	20	Adjusts 321.4 MHz bandpass filter.
A6A3A1C12	C12	20	Adjusts 32 1.4 MHz bandpass filter.
A6A3A1C23	10.7 MHz NOTCH	20	Adjusts 10.7 MHz notch filter.
A6A9A1C29	TRIPLER MATCH	18	Adjusts for maximum 300 MHz output.
A6A9A1R11	CAL OUTPUT	19	Adjusts output level of CAL OUTPUT.
A6A9A1R38	BALANCE	21	Adjusts phase lock tune voltage level.

Table 3-2. Adjustable Components (continued)

Reference Designator	Adjustment Name	Adjustment Number	Adjustment Function
A6A10R1	IO	21	Adjusts 3.3 GHz oscillator drive current.
A6A10R9	VE	21	Adjusts mixer bias 18.6 to 22 GHz.
A6A10R12	VD	21	Adjusts mixer bias 12.5 to 18.6 GHz.
A6A10R15	v c	21	Adjusts mixer bias 5.8 to 12.5 GHz.
A6A10R18	VB	21	Adjusts mixer bias 2 to 5.8 GHz.
A6A10R21	GA	21	Adjusts IF gain 0.01 to 2.5 GHz.
A6A10R23	GB	21	Adjusts IF gain 2 to 5.8 GHz.
A6A10R25	GC	21	Adjusts IF gain 5.8 to 12.5 GHz.
A6A10R27	GD	21	Adjusts IF gain 12.5 to 18.6 GHz.
A6A10R29	GE	21	Adjusts IF gain 18.6 to 22 GHz.
A6A10R31	LR1	21	Adjusts linearity 5.8 to 12.5 GHz (high end).
A6A10R34	LR2	21	Adjusts linearity 12.5 to 18.6 GHz (low end).
A6A10R37	LR3	21	Adjusts linearity 12.5 to 18.6 GHz (high end).
A6A10R40	LB1	21	Adjusts linearity 5.8 to 12.5 GHz.
A6A10R41	LB2	21	Adjusts linearity 12.5 to 18.6 GHz (low end).
A6A10R42	LB3	21	Adjusts linearity 12.5 to 18.6 GHz (high end).
A6A10R70	LB4	21	Adjusts linearity 18.6 to 22 GHz.
A6A10R76	LR4	21	Adjusts linearity 18.6 to 22 GHz (high end).
A6A10R81	GF	21	Adjusts IF gain in external mixer band.
A6A11R48	A1	21	Adjusts flatness 0.01 to 2.5 GHz (low end).
A6A11R51	B1	21	Adjusts flatness 2 to 5.8 GHz (low end).
A6A11R54	C1	21	Adjusts flatness 5.8 to 12.5 GHz (low end).
A6A11R57	D1	21	Adjusts flatness 12.5 to 18.6 GHz (low end).
A6A11R60	E1	21	Adjusts flatness 18.6 to 22 GHz (low end).
A6A11R66	A2	21	Adjusts flatness 0.01 to 2.5 GHz (high end).
A6A11R69	B2	21	Adjusts flatness 2 to 5.8 GHz (high end).
A6A11R72	c2	21	Adjusts flatness 5.8 to 12.5 GHz (high end).
A6A11R75	D2	21	Adjusts flatness 12.5 to 18.6 GHz (high end).
A6A11R78	E2	21	Adjusts flatness 18.6 to 22 GHz (high end).
A6A11R84	GAIN	21	Adjusts overall slope gain.
A6A12R24	D3	21	Adjusts auto-sweep tracking.
A6A12R25	D2	21	Adjusts auto-sweep tracking.
A6A12R26	D1	21	Adjusts auto-sweep tracking.
A6A12R63	5.8 GHz	21	Adjusts tracking at 5.8 GHz (2 to 5.8).
A6A12R66	2 GHz	21	Adjusts tracking at 2 GHz (2 to 5.8).

Table 3-2. Adjustable Components (continued)

Reference Designator	Adjustment Name	Adjustment Number	Adjustment Function
A6A12R82	E	21	Adjusts tracking at 18.6 GHz (18.6 to 22).
A6A12R83	D	21	Adjusts tracking at 12.5 GHz (12.5 to 18.6).
A6A12R84	C	21	Adjusts tracking at 5.8 GHz (5.8 to 12.5).
A6A12R85	B	21	Adjusts tracking at 4 GHz (2 to 5.8).
A6A12R98	ZERO	21	Sets SWEEP + TUNE OUT zero indication.
A6A12R113	-9 v	21	Sets -9 V and +9 V dc reference supplies.
A7A2C1	400 MHz OUT	14	Peaks 400 MHz output signal.
A7A2C2	400 MHz OUT	14	Peaks 400 MHz output signal.
A7A2C3	400 MHz OUT	14	Peaks 400 MHz output signal.
A7A2C4	100 MHz	14	Adjusts VCXO frequency.
A7A4A1A1C1	FREQ ADJUST	15	Adjusts VCO frequency.
A7A4A1A1C5	PWR ADJUST	15	Adjusts VCO output level.
A8R2	+ 22V ADJUST	1	Sets +22 V dc supply voltage.
A10A1L7	50 kHz NULL	17	Nulls 50 kHz output.
A10A1L8	50 kHz NULL	17	Nulls 50 kHz output.
A10A3L11	165 MHz NULL	17	Nulls signal at 165 MHz.
A10A3L12	160 MHz NULL	17	Nulls signal at 160 MHz.
A10A3L13	170 MHz NULL	17	Nulls signal at 170 MHz.
A10A4C50	160 MHz PEAK	17	Peaks 160 MHz output signal.
A10A4L11	VCO ADJ	17	Adjusts PLL3 VCO frequency.
A10A4L16	160 MHz PEAK	17	Peaks 160 MHz output signal.
A10A4L17	160 MHz PEAK	17	Peaks 160 MHz output signal.
A10A5R2	150 MHz ADJ	17	Adjusts VCO TUNE voltage at 150 MHz.
A10A5R4	100 MHz ADJ	17	Adjusts VCO TUNE voltage at 100 MHz.
A10A8R4	.2 MHz	17	Sets discriminator pretune at 0.2 MHz.
A10A8R9	.3 MHz	17	Sets discriminator pretune at 0.3 MHz.
A10A8R25	.5 MHz SCAN	17	Adjusts frequency span accuracy (20/30 sweep).
A10A8R27	5 MHz SCAN	17	Adjusts frequency span accuracy (20/30 sweep).
411A2R2	GATE BIAS ADJ	16	Adjusts CIA amplifier gate biasing.

Table 3-2. Adjustable Components (continued)

Reference Designator	Adjustment Name	Adjustment Number	Adjustment Function
A11A5C1	IMPEDANCE MATCH	16	Optimizes sampler output.
A11A5C2	IMPEDANCE MATCH	16	Optimizes sampler output.
A11A5R1	IF GAIN	13	Adjusts level of 30 MHz output.
A16R62	OFFSET	13	Adjusts scan ramp offset.
A16R67	SWEETIME	13	Adjusts time of sweep ramp.
A16R68	AUX	13	Adjusts AUX OUT sweep ramp.
A16R71	GAIN 2	13	Adjusts frequency span accuracy (YTO sweep).
A16R72	GAIN 1	13	Adjusts frequency span accuracy (YTO sweep).
A17R50	+ 20V ADJ	1	Adjusts + 20 V dc supply voltage.
A19R9	-12.6 VR	13	Adjusts -12.6 V reference for YTO dAC high end (6.2 GHz).
A19R19	OFFSET	13	Adjusts summing amplifier offset.
A19R32	2.5 GHz SPAN	13	Adjusts 5.8 GHz switchpoint overlap.
A19R41	25 GHz SPAN OFFSET	13	Adjusts 25 GHz span offset.
A19R43	25 GHz SPAN	13	Adjusts 5.8 and 12.5 GHz switchpoint overlaps.
A19R50	+ 10 VR	13	Adjusts HOV reference for YTO DAC low end (2 GHz).
A19R56	2.5 GHz SPAN OFFSET	13	Adjusts 2.5 GHz span offset.
A20R25	6.15 GHz	13	Sets high-end frequency of YTO.
A20R34	2.3 GHz	13	Sets low-end frequency YTO.
A22A2	FREQ ADJ	12	Adjusts reference oscillator frequency.
For Serial Prefix 2737A and below , see back of table for A22 exceptions.			
IF Serial Prefix 3001A and Below			
A1A2C10	C10	3	Adjusts rise and fall times of Z axis amplifier pulse.
A1A2R5	INTENSITY	3	Sets adjustment range of front-panel INTENSITY control.
A1A2R22	GAIN HF GAIN	3	Adjusts rise and fall times of Z axis amplifier pulse.
A1A2R30	FOCUS GAIN	3	Coarse adjusts CRT focus; sets range of front-panel FOCUS control.

Table 3-2. Adjustable Components (continued)

Reference Designator	Adjustment Name	Adjustment Number	Adjustment Function
A1A2R31	ORTHO	3	Sets orthogonality of CRT.
A1A2R32	PATTERN	3	Adjusts for optimum rectangular shape of CRT display.
A1A2R35	INTENSITY	3	Sets adjustment range of front-panel INTENSITY control.
A1A2R36	LIMIT		
A1A2R36	ASTIG	3	Adjusts astigmatism of CRT.
A1A2R30	FOCUS GAIN	4	Adjusts for optimum focus of CRT display.
A1A3R14	FOCUS LIMIT	3	Coarse adjusts CRT focus.
A1A4C10	CI0	3	Adjusts rise and fall times of X deflection amplifier pulse.
A1A4C11	CI1	3	Adjusts rise and fall times of X deflection amplifier pulse.
A1A4R7	X POSN	3	Adjusts horizontal position of trace.
A1A4R27	X GAIN	3,4	Adjusts horizontal gain of trace.
A1A4R28	HFGAIN	3	Adjusts rise and fall times of X deflection amplifier pulse.
A1A5C10	CI0	3	Adjusts rise and fall times of Y deflection amplifier pulse.
A1A5C11	CI1	3	Adjusts rise and fall times of Y deflection amplifier pulse.
A1A5R7	Y POSN	3,4	Adjusts vertical position of trace.
A1A5R27	Y GAIN	3,4	Adjusts vertical gain of trace.
A1A5R28	HF GAIN	3,4	Adjusts rise and fall times of Y deflection amplifier pulse.
A1A6R9	+ 15 SV ADJ	1	Adjusts + 15 V dc supply voltage.
A1A6R32	HV ADJUST	2	Adjusts CRT high voltage.
A3A8R9	FS	23	Adjusts high end of digitized sweep.
A3A8R14	ZERO	23	Adjusts low end of digitized sweep.
IF Serial Prefix 2637A and Below			
A22	COARSE	12	Coarse-adjusts reference oscillator frequency.
A22	FINE	12	Fine-adjusts reference oscillator frequency.

Table 3-3. Factory-Selected Components

Reference Designator	Adjustment Procedure	Range of Values (Ω or pF)	Function of Component	
A1A2R9	3	2.87 K to 6.19 K	Sets intensity level.	
A3A1R72		19.6 K to 42.2 K	Sets intensity level.	
A3A2R17		121 K to 162 K	Sets intensity level.	
A3A2R21		10.0 K to 26.1 K	Sets intensity level.	
A3A3C27		Open or 1.0-10.0	Compensates for feedthrough of INTG signal to U1.	
A3A3C32	5	1.0 to 10.0	Compensates for feedthrough of INTG signal to U11.	
A3A3R47		5.0 K to 12.5 K	Compensates for DAC ladder resistance.	
A3A3R48		5.0 K to 12.5 K	Compensates for DAC ladder resistance.	
A4A1R10		562 to 1.33 K	Sets adjustment range of A4A1R36 FS	
A4A1R67	5	56.2 K to 825 K	Compensates for ON resistance of A4A1Q6	
A4A2R18		68.1 to 178	Sets adjustment range of LG20.	
A4A2R22		1.96 K to 5.11 K	Adjusts log fidelity.	
A4A2R24		1 K to 31.6 K	Log fidelity.	
A4A2R36		90.9 to 237	Adjusts overall linear gain.	
A4A2R62		16.2 to 46.4	Sets adjustment range of ATTEN.	
A4A2R86		100 to OPEN	Temperature compensation	
A4A2R88		1 K to OPEN	Temperature compensation	
A4A2R89		1 K to OPEN	Temperature compensation	
A4A2R96		1 K to OPEN	Temperature compensation	
A4A2R97		1 K to OPEN	Temperature compensation	
A4A2R99		1 K to OPEN	Temperature compensation	
A4A3C51		5	390 to 680	Adjusts bandpass filter shape in wide bandwidths (> 100 kHz).
A4A3C52			OPEN or 5.6-15.0	Sets adjustment range of CTR.
A4A3C53	91 to 130		Sets adjustment range of CTR.	
A4A3R15	10.0 to 82.5		Log fidelity	
A4A3R25	19.6 to 82.5		Log fidelity	
A4A3R29	51.1 to 1 K		Log fidelity	
A4A3R35	10.0 to 61.9		Log fidelity	
A4A3R38	61.9 to 1.96 K		Log fidelity	
A4A3R47	2.15 K to 13.3 K		Log fidelity	
A4A3R54	51.1 to 133		Sets adjustment range of LG10.	
A4A3R66	5	46.4 K to 215 K	Sets adjustment range of AMPD.	

Table 3-3. F&tory-Selected Components (continued)

Reference Designator	Adjustment Procedure	Range of Values (Ω or pF)	Function of Component
A4A3R74		1.78 K to 13.3 K	Log fidelity
A4A3R79		8.25 K to 82.5 K	Bandpass filter temperature compensation
A4A3R80		1.0 K to 6.81 K	Bandpass filter temperature compensation
A4A3R81		1 K-OPEN	Bandpass filter temperature compensation
A4A4C10	8	1.0 to 8.2	Sets adjustment range of SYM.
A4A4C17	8	180 to 270	Sets adjustment range of LC CTR.
A4A4C38	8	1.0 to 8.2	Sets adjustment range of SYM.
A4A4C66	8	1.0 to 8.2	Sets adjustment range of SYM.
A4A4C70	8	180 to 270	Sets adjustment range of LC CTR.
A4A4C92	8	180 to 270	Sets adjustment range of LC CTR.
A4A4C97	8	180 to 270	Sets adjustment range of LC CTR.
A4A4R3		0 to 9.09	Matches amplitude of LC to XTAL bandwidths.
A4A4R16		3.16 K to 8.25 K	Adjusts LC filter bandwidth.
A4A4R20		6.19 K to 12.1 K	Adjusts crystal filter bandwidth.
A4A4R35		383 to 825	Matches amplitude of LC to XTAL bandwidths.
A4A4R40		6.19 K to 12.1 K	Adjusts crystal filter bandwidth.
A4A4R42		1 K to OPEN	Sets level of + 10 V TC supply.
A4A4R44		1 K to OPEN	Sets level of + 10 V TC supply.
A4A4R45		0 to 100	Adjusts bandwidth shape in 10 kHz bandwidth.
A4A4R60		3.16 K to 8.25 K	Adjusts LC filter bandwidth.
A4A4R64		6.19 K to 12.1 K	Adjusts crystal filter bandwidth.
A4A4R65		909 to 2.73 K	Adjusts positive feedback.
A4A4R94		100 K to 1M	Sets adjustment range of LC amplitudes.
A4A5C9	10	0-16	Sets adjustment range of FREQ ZERO COARSE.
A4A5R10	11	1.62 K to 2.61 K	Sets 18.4 MHz Local Oscillator power.
A4A5R62	10	1.33 K to 3.48 K	Adjusts A8dB step.
A4A5R70	10	472 to 1.62 K	Adjust A4dB step.
A4A5R86	10	215 to OPEN	Adjusts A2dB step.
A4A6A2R33		42.2 to 75.0	Adjusts level of 3 MHz output.
A4A7C5		56 to 82	Centers first pole.
A4A7C12	7	56 to 82	Sets adjustment range of second pole P K.
A4A7C21	7	56 to 82	Sets adjustment range of third pole P K.
A4A7C30	7	56 to 82	Sets adjustment range of fourth pole P K.
A4A7C39	7	56 to 82	Sets adjustment range of fifth pole P K.
A4A7C93	7	1.5 to 12.0	Centers first pole.
A4A7R12		10.0 K to 17.8 K	Adjusts crystal filter bandwidth.
A4A7R13		10.0 K to 17.8 K	Adjusts crystal filter bandwidth.
A4A7R23		10.0 K to 17.8 K	Adjusts crystal filter bandwidth.
A4A7R24		10.0 K to 17.8 K	Adjusts crystal filter bandwidth.

Table 3-3. Factory-Selected Components (continued)

Reference Designator	adjustment Procedure	Range of Values (Ω or pF)	Function of Component
A4A7R34	10	10.0 K to 17.8 K	Adjusts crystal filter bandwidth.
A4A7R35		10.0 K to 17.8 K	Adjusts crystal filter bandwidth.
A4A7R45		10.0 K to 17.8 K	Adjusts crystal filter bandwidth.
A4A7R46		10.0 K to 17.8 K	Adjusts crystal filter bandwidth.
A4A7R56		7.50 K to 13.3 K	Adjusts crystal filter bandwidth.
A4A7R57		7.50 K to 13.3 K	Adjusts crystal filter bandwidth.
A4A7R60		38.3 to 68.1	Compensates for gain of A4A6A1 .
A4A7R66		38.3 to 68.1	Adjusts crystal filter bandwidth.
A4A7R68		100 to 178	Adjusts crystal filter bandwidth.
A4A7R70		383 to 681	Adjusts crystal filter bandwidth.
A4A7R72		1.47 K to 2.61 K	Adjusts crystal filter bandwidth.
A4A7R74		38.3 to 68.1	Adjusts crystal filter bandwidth.
A4A7R76		100 to 178	Adjusts crystal filter bandwidth.
A4A7R78		383 to 681	Adjusts crystal filter bandwidth.
A4A7R80		1.47 K to 2.61 K	Adjusts crystal filter bandwidth.
A4A7R82		38.3 to 68.1	Adjusts crystal filter bandwidth.
A4A7R84		100 to 178	Adjusts crystal filter bandwidth.
A4A7R86		383 to 681	Adjusts crystal filter bandwidth.
A4A7R88		1.47 K to 2.61 K	Adjusts crystal filter bandwidth.
A4A7R90		3.83 to 68.1	Adjusts crystal filter bandwidth.
A4A7R92		100 to 178	Adjusts crystal filter bandwidth.
A4A7R94		383 to 681	Adjusts crystal filter bandwidth.
A4A7R96		1.47 K to 2.61 K	Adjusts crystal filter bandwidth.
A4A7R98		3.83 to 68.1	Adjusts crystal filter bandwidth.
A4A7R100		100 to 178	Adjusts crystal filter bandwidth.
A4A7R102		383 to 681	Adjusts crystal filter bandwidth.
A4A7R104		1.47 K to 2.61 K	Adjusts crystal filter bandwidth.
For Option 462 , see back of this table for exceptions to A4A7 .			
A4A8C14	8	1.0 to 8.2	Sets adjustment range of SYM.
A4A8C35	8	180 to 270	Sets adjustment range of LC CTR.
A4A8C43	8	1.0 to 8.2	Sets adjustment range of SYM.
A4A8C49	8	180 to 270	Sets adjustment range of LC CTR.
A4A8C78		180-270	Sets adjustment range of LC CTR.
A4A8C81		180-270	Sets adjustment range of LC CTR.

Table 3-3. Factory-Selected Components (continued)

Reference Designator	Adjustment Procedure	Range of Values (Ω or pF)	Function of Component
A4A8R19		100 K1 to 1M	Sets adjustment range of LC amplitude.
A4A8R24		0 to 100	Adjusts bandwidth shape in 10 kHz bandwidth.
A4A8R26		3.83 K to 9.09 K	Adjusts crystal filter bandwidth.
A4A8R29		909 to 2.37 K	Adjusts LC mode feedback.
A4A8R30		3.16 K to 8.25 K	Adjusts LC filter bandwidth.
A4A8R34		100 K to OPEN	
A4A8R36		100 K to OPEN	(85662-60131 only)
A4A8R36		10 K to OPEN	(85662-60190 only)
A4A8R52		3.83 K to 9.09 K	Adjusts crystal filter bandwidth.
A4A8R55		3.16 K to 8.25 K	Adjusts LC filter bandwidth.
A4A9R3		6.81 K to 10.0 K	Sets TC of 3 kHz RBW
A4A9R6		38.3 K to 56.2 K	Sets TC of 10 kHz RBW
A4A9R7		28.7 K to 42.2 K	Sets TC of 300 kHz RBW
A4A9R10		6.19 K to 9.09 K	Sets TC of 1 MHz RBW
A4A9R11		1.96 K to 2.87 K	Sets TC of 3 MHz RBW
A4A9R46		82.5 K to 147 K	Sets 1.0 dB step size
A4A9R48		261 K to 464 K	Sets 0.2 dB step size
A4A9R50		56.2 K to 100 K	Sets 1.2 dB step size
A4A9R52		562 K to 1M	Sets 0.4 dB step size
A4A9R55		46.4 K to 82.5 K	Sets 1.8 dB step size
A4A9R57		316 K to 562 K	Sets 0.6 dB step size
A4A9R59		422 K to 750 K	Sets 0.8 dB step size
A4A9R70		619 K to 1.1M	Sets 0.1 dB step size.
A4A9R72		90.0 K to 162 K	Sets 1.6 dB step size.
A4A9R74		61.9 K to 110 K	Sets 1.4 dB step size.
A4A9R83		2.15 K to 8.25 K	Centers 3 kHz BW adjustment range.
A4A9R84		42.2 K to 100 K	Centers 10 kHz BW adjustment range.
A4A9R85		75 K to 178 K	Centers 300 kHz BW adjustment range.
A4A9R86		10.0 K to 17.5 K	Centers 1 MHz BW adjustment range.
A4A9R87		100 to 5.11 K	Centers 3 MHz BW adjustment range.
For Serial Prefix 2813A to 2816A , and Serial Prefix 2810A and below , see the back of this table for exceptions to A4A9 .			

Table 3-3. Factory-Selected Components (continued)

Reference Designator	Adjustment Procedure	Range of Values (Ω or pF)	Function of Component
A6A9A1R5	18	23.7 to 180	Sets sampler drive level
A6A9A1R10	19	909 to 1.21 K	Sets adjustment range of A6A9A1R11 CAL OUTPUT
A6A9A1R27	18	56.2 K	Sets HET UNLOCK delay time constant for HP 85660B (10 K=HP 85660A)
A6A10R86	21	10 to 40 K	Sets adjustment range of A6A10R21 GA
A6A10R87	21	10 to 40 K	Sets adjustment range of A6A10R23 GB
A6A10R88	21	10 to 40 K	Sets adjustment range of A6A10R25 GC
A6A10R89	21	10 to 40 K	Sets adjustment range of A6A10R27 GD
A6A10R90	21	10 to 40 K	Sets adjustment range of A6A10R29 GE
A6A10R91	21	10 to 40 K	Sets adjustment range of A6A10R81 GF
A6A11R2	21	100 K to 196 K	Adjusts band A breakpoint for best flatness.
A6A12C1	21	0.1 to 0.68 μ F	Sets YTX delay compensation.
A6A12C2		0.1 to 0.68 μ F	Sets YTX delay compensation.
A6A12C3	21	OPEN	Not loaded for HP 85660B
A6A12C11	21	0.1 to 0.68 μ F	Sets YTX delay compensation.
A6A12C23	21	0.1 to 0.68 μ F	Sets YTX delay compensation.
A6A12R64	21	13.356 K/15 K	Sets adjustment range of A6A12R63 5.8 GHz
A7A2C8	14	Open to 15 pF	Sets tuning range of A7A2C4.
A7A2L4	14	0.22 to 0.68 μ H	Centers the adjustment range of A7A2 around 100 MHz.
A7A2R3		196 to 511	Sets biasing of A7A2Q5
A7A2R67	14	Open to 825	Sets -10 dBm output level of the 400 MHz signal.
A7A2R68	14	6.8 to 61.9	Sets -10 dBm output level of the 400 MHz signal.
A7A2R69	14	110 to 825	Sets -10 dBm output level of the 400 MHz signal.
A8R6	1	213 to 261	Sets adjustment range of A8R2 +22 V ADJ
A10A3C26		0 to 15	Selected to minimize mixer distortion.
A10A4C49	17	10 to 15 pF	Sets adjustment range of A10A4C50 160 MHz PEAK
A10A4C49	17	10 to 15 pF	Sets adjustment range of A10A4C50 160 MHz PEAK
A10A4R29	17	68.1 to 90.9	Sets output power to -20 dBm at A10A4J2
A10A4R33	17	68.1 to 90.9	Sets output power to -20 dBm at A10A4J2

Table 3-3. Factory-Selected Components (continued)

Reference Designator	Adjustment Procedure	Range of Values (Ω or pF)	Function of Component
A11A4R24		348 to 562	Sets YTO loop gain crossover to 20 ± 2 kHz.
A11A5C22	16	130 to 220 pF	Sets YTO loop response <20 MHz.
A11A5L10	16	2.2 to 3.3 μ F	Sets YTO loop response.
A11A5R22	16	15 to 51.1 Ω	Sets YTO loop response to 30 MHz.
A13C22		620 to 1300	Sets period of microprocessor clock.
A15C10		62 to 91	Sets oscillator frequency to 10 MHz ± 0.75 MHz.
A16R46	13	73.874 K/74.25 K	Sets adjustment range of A16R72 GAIN 1
Serial Prefix 2813A to 2816A			
A4A9R3		8.25 to 12.1 K	Centers 3 kHz BW adjustment range
A4A9R6		82.5 to 121 K	Centers 10 kHz BW adjustment range
A4A9R7		110 to 162 K	Centers 300 kHz BW adjustment range
A4A9R10		14.7 to 21.5 K	Centers 1 MHz BW adjustment range
A4A9R11		162 to 237 K	Centers 3 MHz BW adjustment range
A4A9R46		82.5 to 147 K	Sets 1.0 dB step size
A4A9R48		261 to 464 K	Sets 0.2 dB step size
A4A9R50		56.2 to 100 K	Sets 1.2 dB step size
A4A9R52		562 K to 1 MO	Sets 0.4 dB step size
A4A9R55		46.4 to 82.5 K	Sets 1.8 dB step size
A4A9R57		316 to 562 K	Sets 0.6 dB step size
A4A9R59		422 to 750 K	Sets 0.8 dB step size
A4A9R70		619 K to 1.1 M Ω	Sets 0.1 dB step size
A4A9R72		90 to 162 K	Sets 1.6 dB step size
A4A9R74		61.9 to 110 K	Sets 1.4 dB step size
Serial Prefix 2810A and Below			
A4A9R69		196 K to 348 K	Sets 1.4 dB step size.
A4A9R70		215 K to 383 K	Sets 1 dB step size.
A4A9R71		147 K to 261 K	Sets 1.8 dB step size.

Table 3-3. Factory-Selected Components (continued)

Reference Designator	Adjustment Procedure	Range of Values (Ω or pF)	Function of Component
Option 462			
A4A7R12		5.62 K to 7.5 K	
A4A7R13		5.62 K to 7.5 K	
A4A7R23		5.62 K to 7.5 K	
A4A7R24		5.62 K to 7.5 K	
A4A7R34		5.62 K to 7.5 K	
A4A7R35		5.62 K to 7.5 K	
A4A7R45		5.11 K to 6.81 K	
A4A7R46		5.11 K to 6.81 K	
A4A7R56		5.11 K to 6.81 K	
A4A7R57		5.11 K to 6.81 K	
A4A7R68		99 to 133	
A4A7R70		383 to 681	
A4A7R76		99 to 133	
A4A7R84		99 to 133	
A4A7R86		316 to 619	
A4A7R92		99 to 133	
A4A7R94		316 to 619	
A4A7R100		99 to 133	
A4A7R102		316 to 619	
A4A8R30		6.19 K to 16K	
A4A8R55		6.8 K to 17.6 K	
A4A8C43		1.0 to 8.2	
A4A9R3		4.22 K to 6.19 K	
A4A9R6		21.5 K to 34.8 K	
A4A9R7		51.1 K to 75.0 K	
A4A9R10		11.0 K to 16.2 K	
A4A9R11		2.87 K to 4.22 K	
A4A9R83		7.50 K to 14.7 K	
A4A9R85		162 K to 348 K	
A4A9R86		28.7 K to 61.9 K	
A4A9R87		4.22 K to 8.25	
Option 067			
A4A9R2		215 K to 316 K	Sets TC of 1 kHz RBW (Opt 067)
A4A9R88		100 K to 511 K	Centers 1 kHz BW adjustment range. (Option 067)
A4A9R2		388 to 550 K	Centers 1 kHz BW adjustment range (Opt 067)

Table 3-4. Standard Value Replacement Capacitors

Capacitors					
Type: Tubular Range: 1 to 24 pF Tolerance: 1 to 9.1 pF = ± 0.25 pF 10 to 24 pF = $\pm 5\%$			Type: Dipped Mica Range: 27 to 680 pF Tolerance: $\pm 5\%$		
Value (pF)	KP Part Number	CD	Value (pF)	EP Part Number	CD
1.0	0160-2236	8	27	0160-2306	3
1.2	0160-2237	9	30	0160-2199	2
1.5	0150-0091	8	33	0160-2150	5
1.8	0160-2239	1	36	0160-2308	5
2.0	0160-2240	4	39	0140-0190	7
2.2	0160-2241	5	43	0160-2200	6
2.4	0160-2242	6	47	0160-2307	4
2.7	0160-2243	7	51	0160-2201	7
3.0	0160-2244	8	56	0140-0191	8
3.3	0150-0059	8	62	0140-0205	5
3.6	0160-2246	0	68	0140-0192	9
3.9	0160-2247	1	75	0160-2202	8
4.3	0160-2248	2	82	0140-0193	0
4.7	0160-2249	3	91	0160-2203	9
5.1	0160-2250	6	100	0160-2204	0
5.6	0160-2251	7	110	0140-0194	1
6.2	0160-2252	8	120	0160-2205	1
6.8	0160-2253	9	130	0140-0195	2
7.5	0160-2254	0	150	0140-0196	3
8.2	0160-2255	1	160	0160-2206	2
9.1	0160-2256	2	180	0140-0197	4
10.0	0160-2257	3	200	0140-0198	5
11.0	0160-2258	4	220	0160-0134	1
12.0	0160-2259	5	240	0140-0199	6
13.0	0160-2260	8	270	0140-0210	2
15.0	0160-2261	9	300	0160-2207	3
16.0	0160-2262	0	330	0160-2208	4
18.0	0160-2263	1	360	0160-2209	5
20.0	0160-2264	2	390	0140-0200	0
22.0	0160-2265	3	430	0160-0939	4
24.0	0160-2266	4	470	0160-3533	0
			510	0160-3534	1
			560	0160-3535	2
			620	0160-3536	3
			680	0160-3537	4

Table 3-5.
Standard Value Replacement 0.125 Resistors

Resistors					
Type: Fixed-Film					
Range: 10 to 464K Ohms					
Wattage: 0.125 at 125°C					
Tolerance: ± 1 .0%					
Value (Ω)	HP Part Number	CD	Value (Ω)	HP Part Number	CD
10.0	0757-0346	2	422	0698-3447	4
11.0	0757-0378	0	464	0698-0082	7
12.1	0757-0379	1	511	0757-0416	7
13.3	0698-3427	0	562	0757-0417	8
14.7	0698-3428	1	619	0757-0418	9
16.2	0757-0382	6	681	0757-0419	0
17.8	0757-0294	9	750	0757-0420	3
19.6	0698-3429	2	825	0757-0421	4
21.5	0698-3430	5	909	0757-0422	5
23.7	0698-3431	6	1.0K	0757-0280	3
26.1	0698-3432	7	1.1K	0757-0424	7
28.7	0698-3433	8	1.21K	0757-0274	5
31.6	0757-0180	2	1.33K	0757-03 17	7
34.8	0698-3434	9	1.47K	0757-1094	9
38.3	0698-3435	0	1.62K	0757-0428	1
42.2	0757-0316	6	1.78K	0757-0278	9
46.4	0698-4037	0	1.96K	0698-0083	8
51.1	0757-0394	0	2.15K	0698-0084	9
56.2	0757-0395	1	2.37K	0698-3150	6
61.9	0757-0276	7	2.61K	0698-0085	0
68.1	0757-0397	3	2.87K	0698-3151	7
75.0	0757-0398	4	3.16K	0757-0279	0
82.5	0757-0399	5	3.4813	0698-3152	8
90.9	0757-0400	9	3.83K	0698-3153	9
100	0757-0401	0	4.22K	0698-3154	0
110	0757-0402	1	4.64K	0698-3155	1
121	0757-0403	2	5.11K	0757-0438	3
133	0698-3437	2	5.62K	0757-0200	7
147	0698-3438	3	6.19K	0757-0290	5
162	0757-0405	4	6.81K	0757-0439	4
178	0698-3439	4	7.50K	0757-0440	7
196	0698-3440	7	8.25K	0757-0441	8
215	0698-3441	8	9.09K	0757-0288	1
237	0698-3442	9	10.0K	0757-0442	9
261	0698-3 132	4	11.0K	0757-0443	0
287	0698-3443	0	12.1K	0757-0444	1
316	0698-3444	1	13.3K	0757-0289	2
348	0698-3445	2	14.7K	0698-3156	2
383	0698-3446	3	16.2K	0757-0447	4

Table 3-5.
Standard Value Replacement 0.125 Resistors
(continued)

Resistors					
Type: Fixed-Film Range: 10 to 464K Ohms Wattage: 0.125 at 125°C Tolerance: ±1.0%					
Value (Ω)	HP Part Number	CD	Value (Ω)	HP Part Number	CD
17.8K	0698-3136	8	100K	0757-0465	6
19.6K	0698-3157	3	110K	0757-0466	7
21.5K	0757-0199	3	121K	0757-0467	8
23.7K	0698-3158	4	133K	0698-345 1	0
26.1K	0698-3159	5	147K	0698-3452	1
28.7K	0698-3449	6	162K	0757-0470	3
31.6K	0698-3160	8	178K	0698-3243	8
34.8K	0757-0123	3	196K	0698-3453	2
38.3K	0698-3161	9	215K	0698-3454	3
42.2K	0698-3450	9	237K	0698-3266	5
46.4K	0698-3162	0	261K	0698-3455	4
51.1K	0757-0458	7	287K	0698-3456	5
56.2K	0757-0459	8	316K	0698-3457	6
61.9K	0757-0460	1	348K	0698-3458	7
68.1K	0757-0461	2	383K	0698-3459	8
75.0K	0757-0462	3	422K	0698-3460	1
82.5K	0757-0463	4	464K	0698-3260	9
90.9K	0757-0464	5			

Table 3-6. Standard Value Replacement 0.5 Resistors

Resistors					
Type: Fixed-Film Range: 10 to 1.47M Ohms Wattage: 0.5 at 125°C Tolerance: ±1.0%					
Value (Ω)	HP Part Number	⊘	Value (Ω)	HP Part Number	⊘
10.0	0757-0984	4	383	0698-3404	3
11.0	0575-0985	5	422	0698-3405	4
12.1	0757-0986	6	464	0698-0090	7
13.3	0757-0001	6	511	0757-0814	9
14.7	0698-3388	2	562	0757-0815	0
16.2	0757-0989	9	619	0757-0158	4
17.8	0698-3389	3	681	0757-0816	1
19.6	0698-3390	6	750	0757-08 17	2
21.5	0698-3391	7	825	0757-08 18	3
23.7	0698-3392	8	909	0757-08 19	4
26.1	0757-0003	8	1.00K	0757-0159	5
28.7	0698-3393	9	1.10K	0757-0820	7
31.6	0698-3394	0	1.21K	0757-082 1	8
34.8	0698-3395	1	1.33K	0698-3406	5
38.3	0698-3396	2	1.47K	0757-1078	9
42.2	0698-3397	3	1.62K	0757-0873	0
46.4	0698-3398	4	1.78K	0698-0089	4
51.1	0757-1000	7	1.96K	0698-3407	6
56.2	0757-1001	8	2.15K	0698-3408	7
61.9	0757-1002	9	2.37K	0698-3409	8
68.1	0757-0794	4	2.61K	0698-0024	7
75.0	0757-0795	5	2.87K	0698-3101	7
82.5	0757-0796	6	3.16K	0698-3410	1
90.0	0757-0797	7	3.48K	0698-3411	2
100	0757-0198	2	3.83K	0698-3412	3
110	0757-0798	8	4.22K	0698-3346	2
121	0757-0799	9	4.64K	0698-3348	4
133	0698-3399	5	5.11K	0757-0833	2
147	0698-3400	9	5.62K	0757-0834	3
162	0757-0802	5	6.19K	0757-0196	0
178	0698-3334	8	6.81K	0757-0835	4
196	0757-1060	9	7.50K	0757-0836	5
215	0698-3401	0	8.25K	0757-0837	6
237	0698-3102	8	9.09K	0757-0838	7
261	0757-1090	5	10.0K	0757-0839	8
287	0757-1092	7	12.1K	0757-0841	2
316	0698-3402	1	13.3K	0698-3413	4
348	0698-3403	2	14.7K	0698-3414	5

Table 3-6.
Standard Value Replacement 0.5 Resistors
(continued)

Resistors					
Type: Fixed-Film Range: 10 to 1.47M Ohms Wattage: 0.5 at 125°C Tolerance: ±1.0%					
Value (Ω)	HP Part Number	iii	Value (Ω)	HP Part Number	CD
16.2K	0757-0844	5	162K	0757-0130	2
17.8K	0698-0025	8	178K	0757-0129	9
19.6K	0698-3415	6	196K	0757-0063	0
21.5K	0698-3416	7	215K	0757-0127	7
23.7K	0698-3417	8	237K	0698-3424	7
26.1K	0698-3418	9	261K	0757-0064	1
28.7K	0698-3103	9	287K	0757-0154	0
31.6K	0698-3419	0	316K	0698-3425	8
34.8K	0698-3420	3	348K	0757-0195	9
38.313	0698-3421	4	383K	0757-0133	5
42.2K	0698-3422	5	422K	0757-0134	6
46.4K	0698-3423	6	464K	0698-3426	9
51.1K	0757-0853	6	511K	0757-0135	7
56.2K	0757-0854	7	562K	0757-0868	3
61.9K	0757-0309	7	619K	0757-0136	8
68.1K	0757-0855	8	681K	0757-0869	4
75.0K	0757-0856	9	750K	0757-0137	9
82.5K	0757-0857	0	825K	0757-0870	7
90.9K	0757-0858	1	909K	0757-0138	0
100K	0757-0367	7	1M	0757-0059	4
110K	0757-0859	2	1.1M	0757-0139	1
121K	0757-0860	5	1.21M	0757-0871	8
133K	0757-0310	0	1.33M	0757-0194	8
147K	0698-3175	5	1.47M	0698-3464	5

1. Low-Voltage Power Supply Adjustments

Reference

IF-Display Section:

A1A6 ±15 V Regulator

A1A7 + 120 V, +5.2 V Regulator (Serial Number Prefix 3004A and above)

A1A7 + 100 V, +5.2 V Regulator (Serial Number Prefix 3001A and below)

RF Section:

A8 Rectifier

A17 Positive Regulator

A 18 Negative Regulator

Description

The + 15 Vdc power supply is adjusted for the IF-Display Section, and the +22 Vdc and +20 Vdc power supplies are adjusted for the RF Section. All other low-voltage supplies are measured to ensure that they are within tolerance.

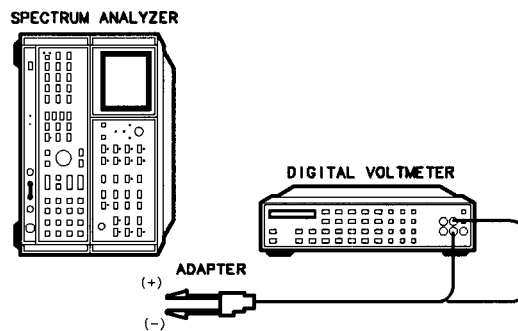

Figure 3-1. Low-Voltage Power Supply Adjustments Setup

Equipment

Digital Voltmeter (DVM) HP 3456A

1. Low-Voltage Power Supply Adjustments

Procedure

IF-Display Section

1. Position the instrument on its right side with the IF-Display Section facing right, as shown in Figure 3-1. Remove the top cover of the IF-Display Section and the bottom cover of the RF Section.
2. Set the spectrum analyzer LINE switch to ON. The MAINS power-on indicator A1A8DS1 (red LED) in the IF-Display Section should be lit. See Figure 3-2 or Figure 3-3 for the location of A1A8DS1.

Note

Use Figure 3-2 for IF-Display Sections with serial number prefix 3001A and below. Use Figure 3-3 for IF-Display Sections with serial numbers 3004A and above.

3. Verify that the + 15 V indicator A1A6DS1 (yellow LED) is lit.
4. Connect the DVM to A1A6TP3 on the IF-Display Section. The DVM indication should be + 15.000 f0.010 V dc. If the voltage is out of tolerance, adjust A1A6R9 + 15 V ADJ for the specified voltage.

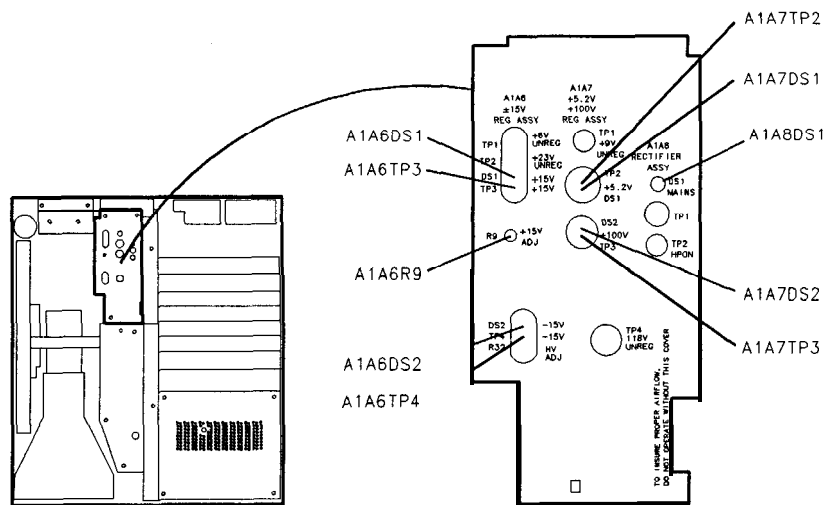

Figure 3-2.
IF-Display Section Adjustments (SN 3001A and Below)

1. Low-Voltage Power Supply Adjustments

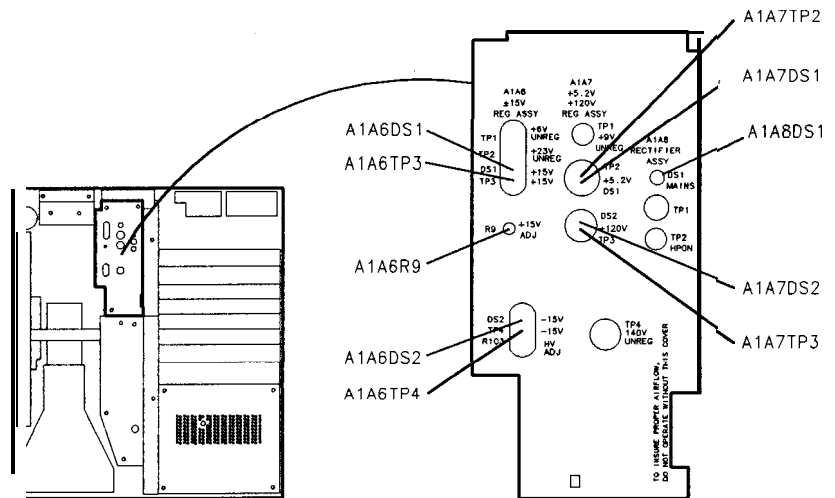

Figure 3-3.
IF-Display Section Adjustments (SN 3004A and Above)

5. Verify that the -15 V indicator **A1A6DS2** (yellow LED) is lit.
6. Connect the DVM to **A1A6TP4**. The DVM indication should be -15.000 f0.050 V dc. The -15 V supply is referenced to the + 15 V supply; therefore, if the -15 V supply is out of tolerance, a circuit malfunction is indicated.
7. Verify that the + 120 V indicator **A1A7DS2** (yellow LED) is lit.

Note

On IF-Display Sections with serial number prefix 3001A and below, indicator **A1A7DS2** is a + 100 V indicator.

8. Connect the DVM to **A1A7TP3**. The DVM indication should be + 120.0 f3.0 V dc. The + 120 V supply is referenced to the + 15 V supply; therefore, if the + 120 V supply is out of tolerance, a circuit malfunction is indicated.

Note

On IF-Display Sections with serial number prefix 3001A and below, the DVM indication should be + 100.0 f2.0 V dc.

9. Verify that the +5.2 V indicator **A1A7DS1** (yellow LED) is lit.
10. Connect the DVM to **A1A7TP2**. The DVM indication should be +5.200 f0.050 V dc. The +5.2 V supply is referenced to the + 15 V supply; therefore, if the +5.2 V supply is out of tolerance, a circuit malfunction is indicated.

1. Low-Voltage Power Supply Adjustments

- RF Section**
11. With the LINE switch still ON, the RF Section's +22 V indicator A8DS1 (yellow LED) should be lit. See Figure 3-4.
 12. Connect the DVM to A8TP1 and the DVM ground lead to chassis ground. Adjust A8R2 +22 V ADJ for a DVM indication of $+22.000 \pm 0.020$ V dc.

Note If A8R2 +22V ADJ does not provide sufficient adjustment range, select a new value for factory-select component A8R6. An increase in the value of A8R6 decreases the voltage at A8TP1. Conversely, a decrease in the value of A8R6 increases the voltage at A8TP1. Refer to Table 3-3 for the acceptable range of values and corresponding HP part numbers for A8R6, and to Figure 3-4 for the location of A8R6.

13. Verify that the +20 V indicator A17DS2 (yellow LED) is lit.
14. Connect the DVM to A17TP4. Adjust A17R50 +20 V ADJ for a DVM indication of $+20.000 \pm 0.001$ V dc.
15. Verify that the +12 V indicator A17DS4 (yellow LED) is lit.
16. Connect the DVM to A17TP6. The DVM indication should be $+12.25 \pm 0.30$ V dc. The +12 V supply voltage is set by a precision voltage regulator; therefore, if the +12 V supply is out of tolerance, a circuit malfunction is indicated.
17. Verify that the +5.2 V indicator A17DS1 (yellow LED) is lit.

1. Low-Voltage Power Supply Adjustments

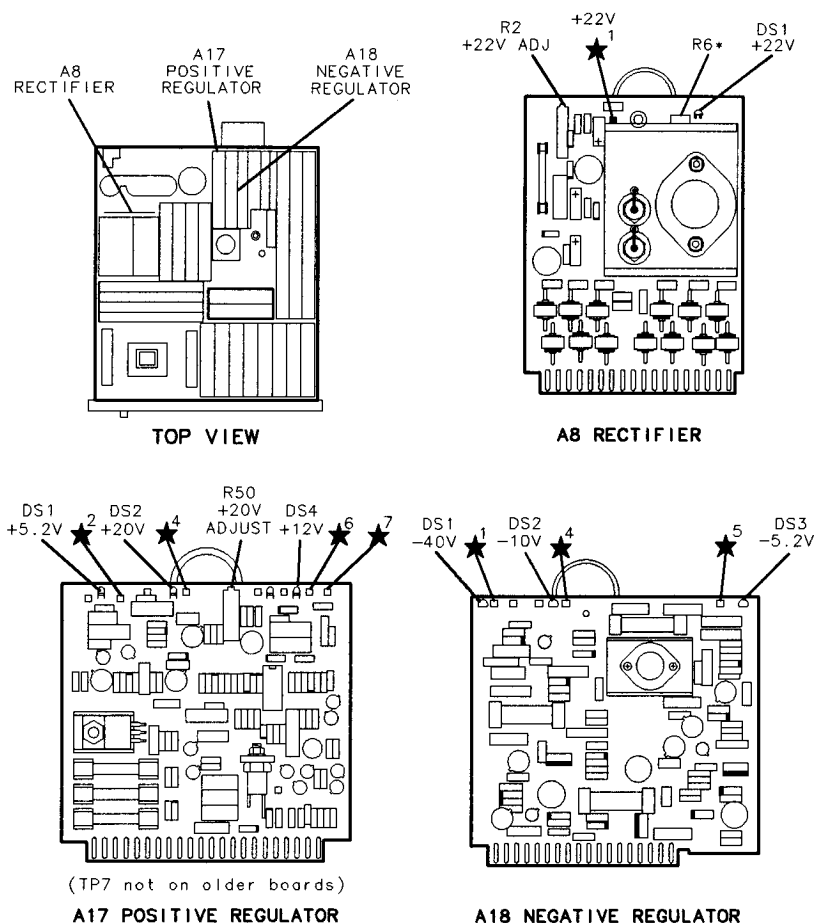

Figure 3-4. Location of RF Section Low-Voltage Adjustments

18. Connect the DVM to A17TP2. The DVM indication should be $+5.20 \pm 0.05$ V dc. The +5.2 V supply is referenced to the +20 V supply; therefore, if the +5.2 V supply is out of tolerance, a circuit malfunction is indicated.
19. Verify that the -5.2 V indicator A18DS3 (yellow LED) is lit.
20. Connect the DVM to A18TP5. The DVM indication should be -5.20 ± 0.05 V dc. The -5.2 V supply is referenced to the +20 V supply; therefore, if the -5.2 V supply is out of tolerance, a circuit malfunction is indicated.
21. Verify that the -40 V indicator A18DS1 (yellow LED) is lit.
22. Connect the DVM to A18TP1. The DVM indication should be -39.8 ± 0.4 V dc. The -40 V supply is referenced to the +20 V supply; therefore, if the -40 V supply is out of tolerance, a circuit malfunction is indicated.
23. Verify that the -10 V indicator A18DS2 (yellow LED) is lit.

1. Low-Voltage Power Supply Adjustments

24. Connect the DVM to A18TP4. The DVM indication should be -10.0 ± 0.1 V dc. The -10 V supply is referenced to the +20 V supply; therefore, if the -10 V supply is out of tolerance, a circuit malfunction is indicated.

2. High-Voltage Adjustment (SN 3001A and Below)

Note This procedure is for IF-Display Sections with serial number prefixes 3001A and below. The procedure for serial prefixes 3004A and above is located immediately after this procedure.

Note This procedure should be performed whenever the A1A11 High Voltage Multiplier, A1V1 CRT, or A1A3 High Voltage Regulator Assembly is repaired or replaced.

Reference IF-Display Section:
A1A2 Z-Axis Amplifier
A1A3 High-Voltage Regulator
A1A6 ± 15 V Regulator
A1A7 + 100 V, +5.2 V Regulator

Description

Warning This procedure is intended for adjustment purposes only. Voltages are present which, if contacted, could cause serious personal injury. Approximately -4000 V dc can be present on the A1A3 High Voltage assembly even when the ac line cord is disconnected. Do not attempt to remove the A1A3 High-Voltage Assembly from the instrument. Do not disconnect the CRT's post-accelerator cable; the CRT can hold a + 18 kV dc charge for several days.

If for any reason the A1A3 High Voltage Assembly or the postaccelerator cable must be removed, refer to "Discharge Procedure for High Voltage and CRT" at the end of this adjustment procedure.

A 1000:1 divider probe is used to measure the CRT cathode voltage. First, the high-voltage probe is calibrated by comparing measurements of the + 100 V dc supply voltage with and without the probe. Any measurement error due to the use of the high-voltage probe is calculated into the adjustment specification of the CRT cathode voltage, which is adjusted with the A1A6 HV ADJUST control. When the CRT cathode voltage is properly adjusted, the CRT filament voltage will be +4.45 f0.04 V rms measured with CRT beam at cut-off, which is required for maximum CRT life. The filament voltage is referenced to the high-voltage cathode and can only be measured directly with special equipment.

2. High-Voltage Adjustment (SN 3001A and Below)

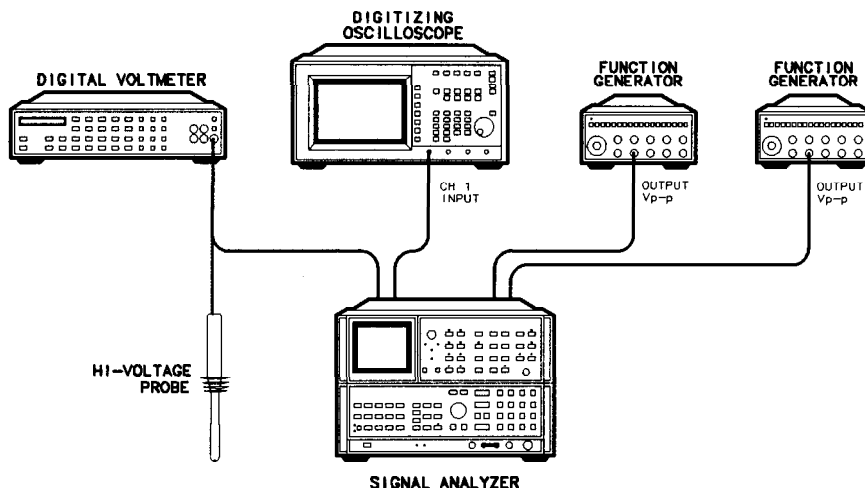

Figure 3-5. High Voltage Adjustment Setup

Equipment	Digital Voltmeter (DVM)	HP 3456A
	DC High-Voltage Probe (1000: 1 divider)	HP 34111A
	Display Adjustment PC Board (<i>service</i> accessory) ...	HP 85662-60088
	Digitizing Oscilloscope	HP 54501A
	10:1 Divider Probe	HP 10432A
	Function Generator (<i>2 required</i>)	HP 3312A

High-Voltage Adjustment Procedure

Warning

In the following procedure, it is necessary to probe voltages which, if contacted, could cause serious personal injury. Use a nonmetallic alignment tool when making adjustments. Be extremely careful.

Warning

Do not attempt to measure the CRT filament voltage directly. The filament voltage is referenced to the high-voltage cathode and can only be measured safely with a special high-voltage true-rms voltmeter and probe.

1. Set the spectrum analyzer LINE switch to STANDBY.
2. Remove the top cover from the IF-Display Section, and connect the equipment as shown in Figure 3-5 and described in the following steps.
3. Set the DVM to the 100 V range, and connect the DVM to A1A7TP3 (+ 100 V). Do not use the high-voltage probe. See Figure 3-6 for the location of A1A7TP3.

Note

The accuracy of the high-voltage probe is specified for a probe connected to a dc voltmeter with 10 M Ω input resistance. HP 3456A and HP 3455A digital voltmeters have a 10 M Ω input resistance on the 100 V and 1000 V ranges. All measurements in this procedure should

2. High-Voltage Adjustment (SN 3001A and Below)

be performed with the DVM manually set to the 100 V range (± 00.000 on the HP 3456A display).

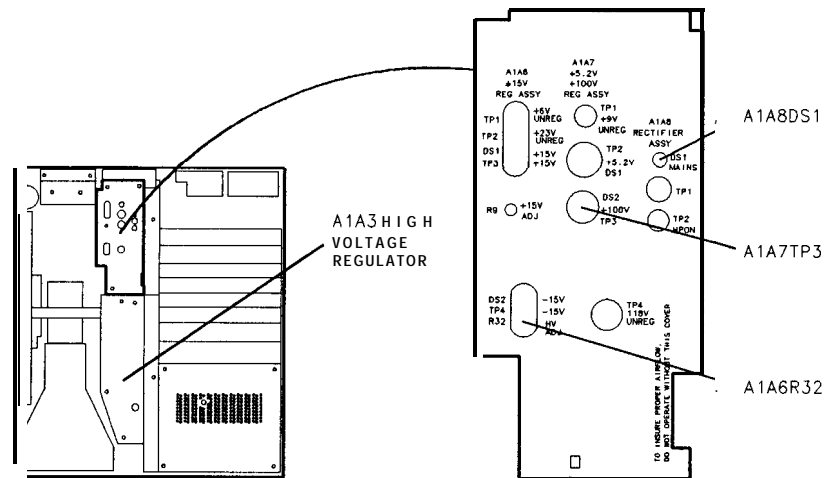

Figure 3-6. Location of High Voltage Adjustments

4. Set the spectrum analyzer LINE switch to ON. Set the front-panel INTENSITY control fully counterclockwise (CRT beam at cut-off) to prevent possible damage to the CRT.

5. Note the DVM indication at A1A7TP3.

DVM Indication: _____

6. Connect the high-voltage probe to the DVM. Connect the probe to A1A7TP3.

7. Note the DVM indication.

DVM Indication: _____

8. Divide the DVM indication in step 7 by the DVM indication in step 5. This gives the calibration factor needed to compensate for high-voltage probe error.

Calibration Factor: _____

9. Disconnect the high-voltage probe from A1A7TP3. Set the spectrum analyzer LINE switch to STANDBY. Remove the ac line cord from both instrument sections.

Warning

The MAINS power-on indicator A1A8DS1 (red LED) should be completely off before proceeding with this procedure. See Figure 3-6. The indicator will remain lit for several seconds after the ac line cord has been removed, and will go out slowly (the light becomes dimmer until it is completely out).

Warning

With the protective cover removed in the following step, do not place hands near the A1A3 High-Voltage assembly. High voltage (approximately -4000 V dc) can be present even when the ac line cord is disconnected.

2. High-Voltage Adjustment (SN 3001A and Below)

10. Wait at least one minute for capacitors to discharge to a safe level.
11. Remove the protective cover from the A1A3 High-Voltage Regulator. A label should be visible on the A1A3T1 High-Voltage Transformer. Record the voltage listed on the label for use in step 15.

Note

If the label is missing, use the nominal value of -3790 Vdc.

12. Connect the high-voltage probe to A1A3TP3. See Figure 3-7 for the location of the test point.

Warning

With power supplied to the instrument, A1A3TP3 is at a voltage level of approximately -4000 V dc. Be extremely careful.

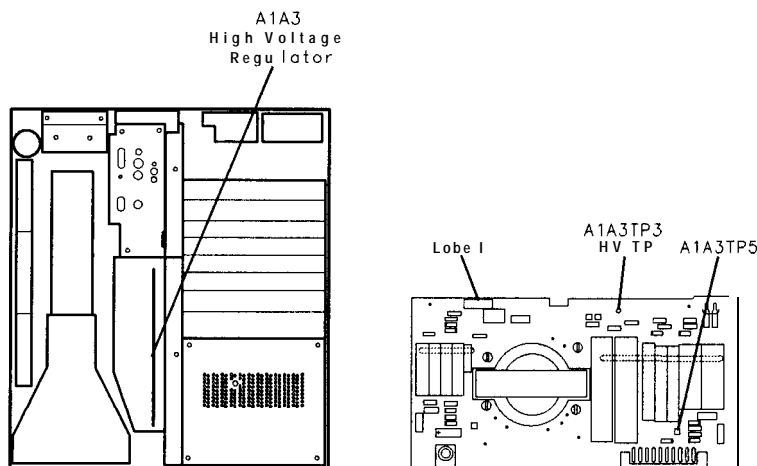

Figure 3-7. Location of Label and Test Point

13. Reconnect ac line cords to both instrument sections. Set the spectrum analyzer LINE switch to ON.
14. Wait approximately 30 seconds for the dc regulator circuits to stabilize.
15. Adjust A1A6R32 HV ADJ for a DVM indication equal to the calibration factor (calculated in step 8) times the voltage labeled on the top of A1A3 High-Voltage Regulator (noted in step 11). See Figure 3-6 for the location of the adjustment.

_____ V dc

EXAMPLE:

If the calibration factor calculated in step 8 is 0.00099, and A1A3T1 is labeled for -3875 V, then adjust A1A6R32 HV ADJ for a DVM indication of:

$$0.00099 \times (-3875 \text{ V}) = -3.836 \text{ V dc}$$

16. With the front-panel INTENSITY control fully counterclockwise, wait approximately 30 minutes to allow the high-voltage supply to

2. High-Voltage Adjustment (SN 3001A and Below)

stabilize and the CRT to normalize. This *soft* turn-on will extend CRT life expectancy, particularly if a new CRT has just been installed.

17. Readjust A1A6R32 HV ADJ for a DVM indication equal to the voltage determined in step 15.
18. If a new CRT has just been installed do the following:
 - a. Set the front-panel INTENSITY control so the CRT trace is barely visible.
 - b. Wait an additional 30 minutes for the CRT to normalize.
 - c. Readjust A1A6R32 HV ADJ for a DVM indication equal to the voltage determined in step 15.

Focus and Intensity Adjustments

19. Set the spectrum analyzer LINE switch to STANDBY. Remove the ac line cord from each instrument section.
20. Wait at least one minute for the MAINS power-on indicator A1A8DS1 (red LED) to go out completely before proceeding.
21. Disconnect the high-voltage probe from A1A3TP3.
22. Remove the A3A2 Intensity Control Assembly from the IF-Display Section and install in its place the Display Adjustment Board, HP part number 85662-60088. Set the switch on the Display Adjustment Board in the "down" position. (This applies approximately +2.7 V dc to the front-panel INTENSITY control.)
23. Connect a calibrated 10:1 divider probe to the oscilloscope Channel 1 input.
24. On the oscilloscope, press **RECALL** **CLEAR** to perform a soft reset.
25. On the oscilloscope, press **CHAN**, **more preset** probe, select channel 1, and use the front-panel knob to select a 10: 1 probe.
26. Set the oscilloscope controls as follows:

Press **CHAN**:

Channel 1	on
amplitude scale	10.0V/div
offset	60.0000V
coupling	dc

Press **TIME BASE**:

time scale	50 μ s/div
------------	-------	----------------

Press **TRIG**:

EDGE TRIGGER	auto, edge
source	1
level	75.0000 V, rising edge

Press **DISPLAY**:

connect dots	on
--------------	-------	----
27. On the oscilloscope press **SHOW**.
28. Connect the oscilloscope channel 1 probe to A1A3TP5 using a long probe extension. See Figure 3-7 for the location of A1A3TP5.
29. Reconnect the ac line cords to each instrument section. Adjust the front-panel INTENSITY control fully counter-clockwise, and

2. High-Voltage Adjustment (SN 3001A and Below)

then set the LINE switch to ON (the INSTR CHECK I LED will light.)

30. Wait approximately 30 seconds for the dc regulator circuits to stabilize again.
31. With the front-panel INTENSITY control fully counter clockwise, adjust **A1A2R35** INT LIMIT (clockwise) until a spot is just visible in the lower left corner of the CRT. See Figure 3-8 for the location of the adjustment.

Note

The **A1A2R35** INT LIMIT adjustment compensates for the variation in beam cut-off voltage of different CRTs and indirectly sets the maximum beam intensity. **A1A2R35** INT LIMIT should have enough range to turn the CRT spot on and off. If the spot is always on, decrease the value of **A1A2R9**. If the spot is **always** off, increase the value of **A1A2R9**. Refer to **Table 3-3** for the acceptable range of values, and to **Table 3-4** for HP part numbers. Refer to Figure 3-8 for the location of **A1A2R9**.

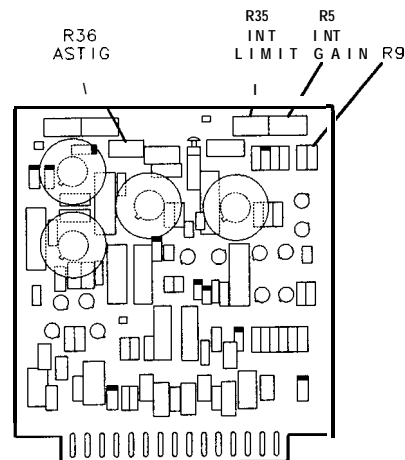

Figure 3-8. Location of A1A2 Components

32. Using a non-metallic alignment tool, center the front panel FOCUS control and adjust **A1A2R36** ASTIG and **A1A3R14** FOCUS LIMIT for a sharp, focused dot on the CRT display.
33. Adjust **A1A2R35** INT LIMIT until the dot just disappears.
34. On the oscilloscope, adjust the channel 1 offset voltage as necessary to measure the peak-to-peak CRT cut-off voltage, V_{co} , at **A1A3TP5**. See Figure 3-9. This peak-to-peak voltage should be between 45-75 V_{p-p} . Note this voltage for use in step 39.

V_{co} : _____ V_{p-p}

2. High-Voltage Adjustment (SN 3001A and Below)

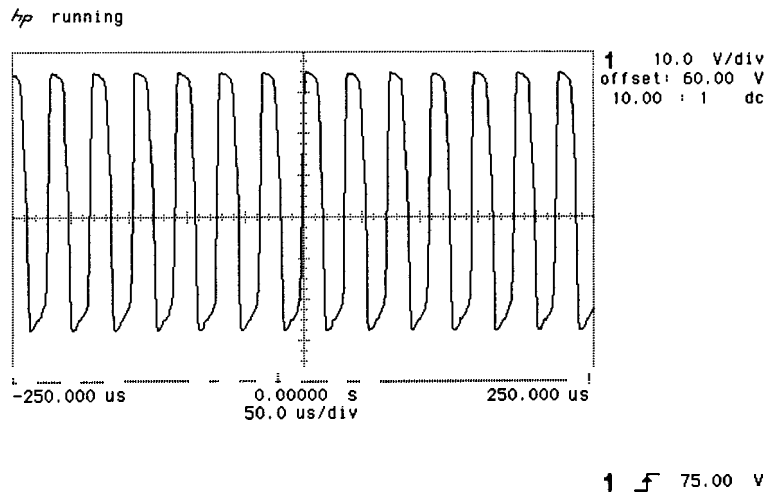

Figure 3-9. CRT Cut-Off Voltage

35. Connect a separate function generator to each of the X and Y inputs of the Display Adjustment Board, as shown in Figure 3-5. Set the function generators as follows:
 - X input J1:
 - frequency 500 kHz
 - wave sine
 - amplitude $2V_{p-p}$ (0–2 Vdc)
 - Y input J2:
 - frequency 1 kHz
 - wave sine
 - amplitude $2V_{p-p}$ (0–2 Vdc)
36. Adjust A1A2R35 INT LIMIT clockwise until the display is just visible.
37. Adjust A1A4R7 POS, A1A5R7 POS, and if necessary the function generator dc offsets for a full-screen illumination.
38. Set the front-panel INTENSITY control fully counter-clockwise, and, if it is not sealed, adjust A1A2R5 INT GAIN fully clockwise. Adjust A1A2R35 INT LIMIT just below the threshold at which the display illumination becomes visible.
39. Slowly adjust the front-panel INTENSITY control through its entire range while monitoring the peak-to-peak voltage at A1A3TP5. As the INTENSITY control is turned clockwise, the peak-to-peak voltage at A1A3TP5 will drop. To prevent long-term CRT damage, this voltage should not drop below $(V_{,} - 50)V_{p-p}$ or

2. High-Voltage Adjustment (SN 3001A and Below)

12 V_{p-p}, whichever is greater. See Figure 3-10. (The value of V_{co} was recorded in step 34.)

If the front-panel INTENSITY control cannot be set fully clockwise without dropping below this minimum peak-to-peak voltage, then perform the following:

- a. Set the INTENSITY control fully counter clockwise.
- b. Set the LINE switch to STANDBY.
- c. Increase the value of A1A2R9.
- d. Return to step 34.

Note

Maximum CRT life expectancy is obtained when the peak-to-peak voltage at A1A3TP5 is as large as possible with the INTENSITY control set fully clockwise. The display illumination must fully disappear with the INTENSITY control set fully counter clockwise.

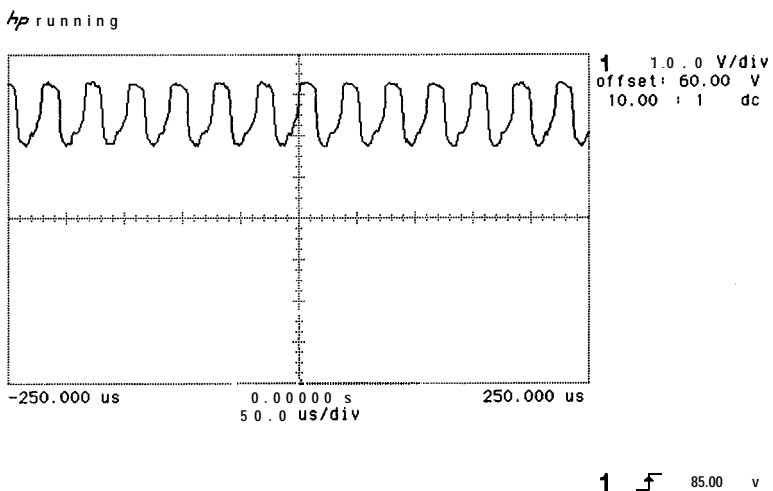

Figure 3-10. Waveform at A1A3TP5

40. Replace the cover on the A1A3 High-Voltage Regulator Assembly.

2. High-Voltage Adjustment (SN 3001A and Below)

41. The High-Voltage Adjustment is completed. If an A1A2, A1A4, or A1A5 assembly has been repaired or replaced, perform adjustment procedure 3, "Preliminary Display Adjustment (SN 3001A and Below)", and then adjustment procedure 4, "Final Display Adjustments (SN 3001A and Below)". If the A1A2, A1A4, and A1A5 assemblies function properly and do not require compensation, proceed directly to adjustment procedure 4, "Final Display Adjustments (SN 3001A and Below)".

Discharge Procedure for High Voltage and CRT

The adjustment procedures in this manual do not require the removal or discharge of the A1A3 High-Voltage Regulator or CRT assemblies. However, if for any reason the A1A3 High Voltage Regulator Assembly or the post-accelerator cable must be removed, the following procedure ensures the proper safety.

Warning

This procedure should be performed by qualified personnel only. Voltages are present which, if contacted, could cause serious personal injury. Approximately -4000 V dc is present on the A1A3 High-Voltage Regulator assembly even when the ac line cord is disconnected. The CRT can hold a + 18 kV dc charge for several days if the post-accelerator cable is improperly disconnected.

Warning

Do not handle the A1A3 High-Voltage Regulator Assembly or A1A1 1 High-Voltage Multiplier until the following high-voltage discharge procedure has been performed.

1. Set the spectrum analyzer's LINE switch to STANDBY, remove the ac line cords, and remove the A1A3 High Voltage Regulator safety cover.

Warning

With the ac power cord disconnected, voltages are still present which, if contacted, could cause serious personal injury.

Warning

In the following step, a large arc of high voltage should be drawn. Be careful.

2. Locate the snap connector on the CRT post-accelerator cable. It is shown in Figure 3-11 as item 1. Using a long flat-bladed screwdriver with an insulated handle, carefully pry the connector loose but do not disconnect the cable.
 - a. Using one hand, remove the end of the cable labeled item 2 in Figure 3-11. As the end of the cable becomes free, touch the end of the cable to the CRT's metal cover. A large arc of high voltage should ground to the CRT cover. The CRT is not discharged yet!
 - b. Reconnect the CRT post-accelerator cable, and repeat the above step until high-voltage arcs no longer appear.
3. Leave the CRT post-accelerator cable disconnected, and remove the cover on the A1A3 High Voltage Regulator.

2. High-Voltage Adjustment (SN 3001A and Below)

4. Connect a jumper wire (insulated wire and two alligator clips) between the shaft of a small screwdriver and the chassis ground lug on the inside of the high-voltage shield.
5. While holding the insulated handle of the screwdriver, touch the grounded blade to the following connections:
 - a. Both brown wires going to the rear of the CRT from A1A3 via cable harness W2 1.
 - b. The yellow, blue, and orange wires in the same cable as “a.” above.
 - c. The top lead of each of the 11 large vertical capacitors on the A1A3 High-Voltage Regulator Assembly.
6. Connect the jumper wire from chassis ground to the black wire coming from the A1A11 High-Voltage Multiplier at the wire's connection to A1A3T1.

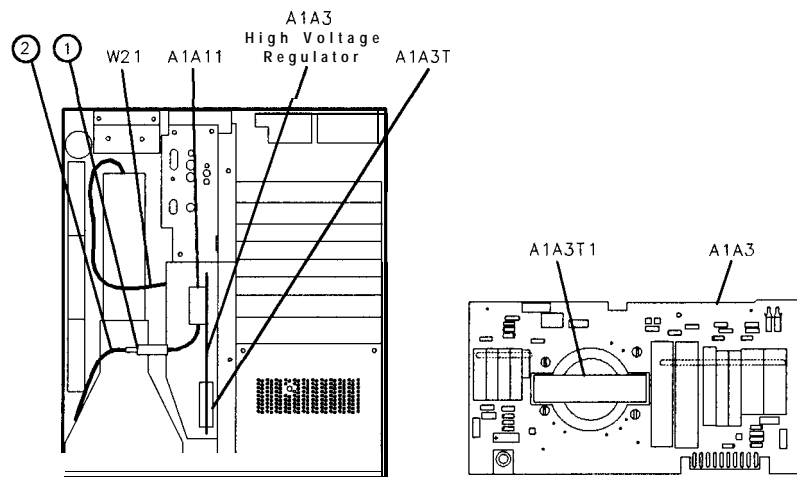

Figure 3-11. Discharging the CRT Post-Accelerator Cable

7. Remove all jumper wires. The A1A3 High-Voltage Regulator, A1A11 High-Voltage Multiplier, and A1V1 CRT assemblies should now be discharged.
8. A small bracket and screw secure the A1A3 High-Voltage Regulator Assembly to the A1A10 Display Motherboard Assembly. The bottom cover of the IF-Display Section must be removed to gain access to this screw prior to removal of the A1A3 High-Voltage Regulator Assembly.

2. High-Voltage Adjustment (SN 3004A and Above)

Note This procedure is for IF-Display Sections with serial number prefixes 3004A and above. The procedure for serial prefixes 3001A and below is located immediately before this procedure.

Note This procedure should be performed whenever the A1V1 CRT or A1A3 High Voltage Regulator Assembly is repaired or replaced.

Reference IF-Display Section:
A1A2 Z-Axis Amplifier
A1A3 High-Voltage Regulator
A1A6 ± 15 V Regulator
A1A7 + 120 V, +5.2 V Regulator

Description

Warning This procedure is intended for adjustment purposes only. Voltages are present which, if contacted, could cause serious personal injury. Approximately -2400 V dc can be present on the A1A3 High Voltage Regulator Assembly even when the ac line cord is disconnected. Do not attempt to remove the A1A3 High-Voltage Regulator Assembly from the instrument. Do not disconnect the CRT's post-accelerator cable; the CRT can hold a + 9500 V dc charge for several days.

If for any reason the A1A3 High Voltage Assembly or the postaccelerator cable must be removed, refer to "Discharge Procedure for High Voltage and CRT" at the end of this adjustment procedure.

A 1000:1 divider probe is used to measure the CRT cathode voltage. First, the high-voltage probe is calibrated by comparing measurements of the + 120 V dc supply voltage with and without the probe. Any measurement error due to the use of the high-voltage probe is calculated into the adjustment specification of the CRT cathode voltage, which is adjusted with the A1A6 HV ADJUST control. When the CRT cathode voltage is properly adjusted, the CRT filament voltage will be $+6.00 \pm 0.05$ V rms measured with CRT beam at cut-off, which is required for maximum CRT life. The filament voltage is referenced to the high-voltage cathode and can only be measured directly with special equipment.

2. High-Voltage Adjustment (SN 3004A and Above)

Equipment	Digital Voltmeter (DVM)	HP 3456A
	DC High-Voltage Probe (1000:1 divider)	HP 34111A

High-Voltage Adjustment Procedure

Warning

In the following procedure, it is necessary to probe voltages which, if contacted, could cause serious personal injury. Use a nonmetallic alignment tool when making adjustments. Be extremely careful.

Warning

Do not attempt to measure the CRT filament voltage directly. The filament voltage is referenced to the high-voltage cathode and can only be measured safely with a special high-voltage true-rms voltmeter and probe.

1. Set the spectrum analyzer LINE switch to STANDBY.
2. Remove the top cover from the IF-Display Section and connect the equipment as shown in Figure 3-12.

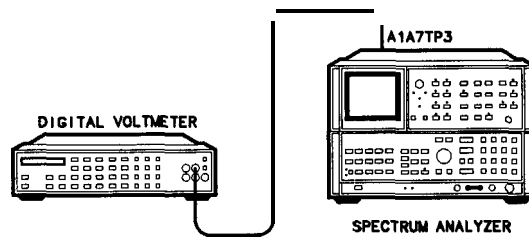

Figure 3-12. High Voltage Adjustment Setup

3. Set the DVM to the 100V range, and connect the DVM to A1A7TP3 (+ 120V) without the high-voltage probe. See Figure 3-13.

Note

The accuracy of the high-voltage probe is specified for a probe connected to a dc voltmeter with 10 MO input resistance. HP 3456A and HP 3455A digital voltmeters have a 10 MO input resistance on the 100 V and 1000 V ranges. All measurements in this procedure should be performed with the DVM manually set to the 100 V range (± 00.000 on the HP 3456A display).

2. High-Voltage Adjustment (SN 3004A and Above)

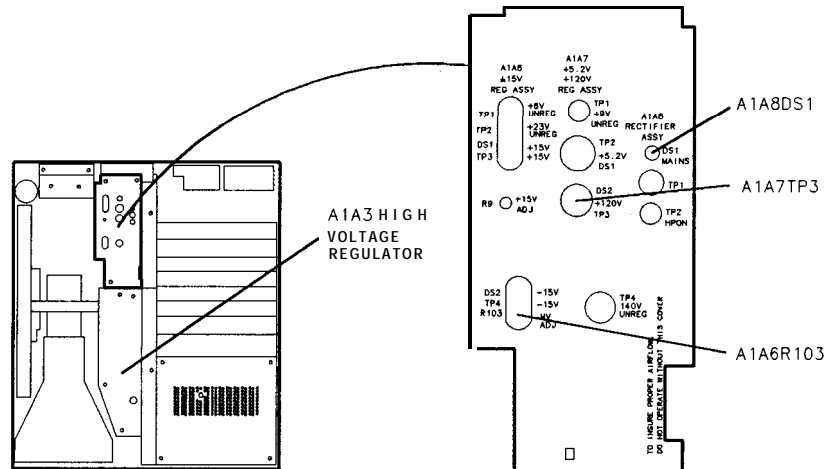

Figure 3-13. Location of High Voltage Adjustments

4. Set the spectrum analyzer LINE switch to ON. Set the front-panel INTENSITY control fully counterclockwise (CRT beam at cut-off) to prevent possible damage to the CRT.
5. Note the DVM indication at A1A7TP3.

DVM Indication: _____

6. Connect the high-voltage probe to the DVM, and connect the probe to A1A7TP3.
7. Note the DVM indication.

DVM Indication: _____

8. Divide the DVM indication in step 7 by the DVM indication in step 5. This gives the calibration factor needed to compensate for high-voltage probe error.

Calibration Factor: _____

9. Disconnect the high-voltage probe from A1A7TP3. Set the spectrum analyzer LINE switch to STANDBY. Remove the ac line cord from both instrument sections.

Warning

The MAINS power-on indicator A1A8DS1 (red LED) should be completely off before proceeding with this procedure. See Figure 3-13 The indicator will remain lit for several seconds after the ac line cord has been removed, and will go out slowly (the light becomes dimmer until it is completely out).

Warning

With the protective cover removed in the following step, do not place hands near the A1A3 High-Voltage assembly. High voltage (approximately -2400 V dc) can present even when the ac line cord is disconnected.

10. Wait at least one minute for capacitors to discharge to a safe level.

2. High-Voltage Adjustment (SN 3004A and Above)

11. Remove the protective cover from the A1A3 High-Voltage Regulator Assembly. A label should be visible on the A1A3A1 High Voltage Assembly. (A1A3A1 is mounted on the non-component side of the High-Voltage Regulator Assembly as shown in Figure 3-14.) Record the voltage listed on the label for use in step 15. In cases where more than one voltage is listed on this label, record the value which is closest to -2400 Vdc.

_____ V dc

Warning

With power supplied to the instrument, A1A3TP2A is at a voltage level of approximately -2400 V dc. Be extremely careful.

12. Connect the high-voltage probe to A1A3TP2A. See Figure 3-14 for the location of the test point.

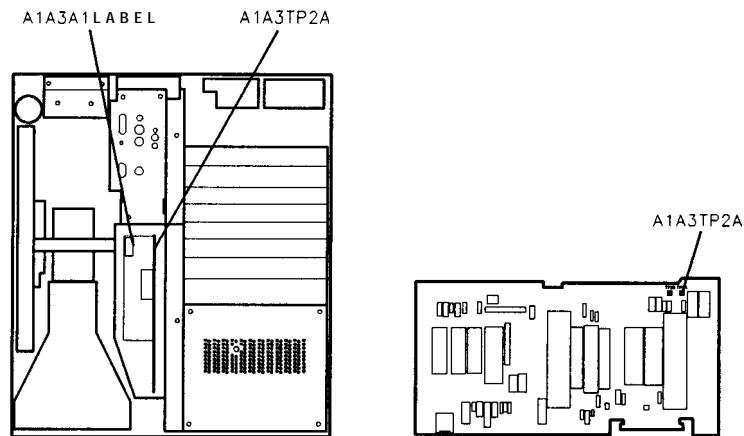

Figure 3-14. Location of A1A3 Label and Test Point

13. Reconnect ac line cords to both instrument sections. Set the LINE switch to ON.
14. Wait approximately 30 seconds for the dc regulator circuits to stabilize.
15. Adjust A1A6R103 HV ADJ for a DVM indication equal to the calibration factor (calculated in step 8) times the voltage labeled on the top of the A1A3A1 High-Voltage Assembly (noted in step 11). See Figure 3-13 for the location of the adjustment.

_____ V dc

EXAMPLE:

If the calibration factor calculated in step 8 is 0.00099, and A1A3A1 is labeled for -2400 V, then adjust A1A6R103 HV ADJ for a DVM indication of:

$$0.00099 \times (-2400 \text{ V}) = -2.376 \text{ V dc}$$

16. With the front-panel INTENSITY control fully counter clockwise, wait approximately 10 minutes to allow the high-voltage supply to stabilize and the CRT to normalize. This *soft* turn-on will extend

2. High-Voltage Adjustment (SN 3004A and Above)

CRT life expectancy, particularly if a new CRT has just been installed.

17. Readjust **A1A6R103** HV ADJ for a DVM indication equal to the voltage determined in step 15.
18. If a new CRT has just been installed do the following:
 - a. Set the front-panel INTENSITY control so the CRT trace is barely visible.
 - b. Wait an additional 30 minutes for the CRT to normalize.
 - c. Readjust **A1A6R103** HV ADJ for a DVM indication equal to the voltage determined in step 15.
19. Set the LINE switch to STANDBY. Remove the ac line cord from each instrument section.
20. Wait at least one minute for the MAINS power-on indicator **A1A8DS1** (red LED) to go out completely before proceeding.
21. Disconnect the high-voltage probe from **A1A3TP2A**.
22. Replace the cover on the **A1A3** High-Voltage Regulator Assembly.
23. The High-Voltage adjustments are now completed. If the **A1A2** assembly has been repaired or replaced, perform adjustment procedure 3, "Preliminary Display Adjustment (SN 3004A and Above)", and then adjustment procedure 4, "Final Display Adjustments (SN 3004A and Above)". If the **A1A2** assembly functions properly and does not require compensation, proceed directly to adjustment procedure 4, "Final Display Adjustments (SN 3004A and Above)".

2. High-Voltage Adjustment (SN 3004A and Above)

Discharge Procedure for High Voltage and CRT

The High-Voltage Adjustment procedure does not require the removal or discharge of the A1A3 High-Voltage Regulator or A1V1 CRT assemblies. However, if for any reason the A1A3 High Voltage Regulator Assembly, the CRT, or the CRT post-accelerator cable must be removed, perform the following procedure to ensure proper safety.

Warning

This procedure should be performed by qualified personnel only. Voltages are present which, if contacted, could cause serious personal injury. Approximately -2400 V dc can be present on the A1A3 High-Voltage Regulator assembly even when the ac line cord is disconnected. The CRT can hold a +9500 V dc charge for several days if the post-accelerator cable is improperly disconnected.

1. Remove the ac line cord from both instrument sections.

Warning

With the ac power cords disconnected, voltages can still be present which, if contacted, could cause serious personal injury.

2. Obtain an electrician's screwdriver which has a thin blade at least eight inches long. The handle of the screwdriver must be made of an insulating material.
3. Connect one end of a jumper wire (made of insulated wire and two alligator clips) to the blade of the screwdriver. Connect the other end of the jumper wire to the metal chassis of the IFDisplay Section. This grounds the screwdriver.
4. Slide the screwdriver's blade between the CRT and the sheet metal as shown in Figure 3-15. Gently work the tip of the screwdriver under the post-accelerator cable's rubber shroud. Make sure that the screwdriver's tip touches the connection between the postaccelerator cable and the CRT. You should hear a cracking sound when the cable discharges.
5. Remove the cover from the A1A3 High-Voltage Regulator assembly.
6. Touch the screwdriver's tip to the top lead of each of the 11 large vertical capacitors on the A1A3 High-Voltage Regulator assembly.
7. The A1A3 High-Voltage Regulator and A1V1 CRT assemblies should now be discharged.

2. High-Voltage Adjustment (SN 3004A and Above)

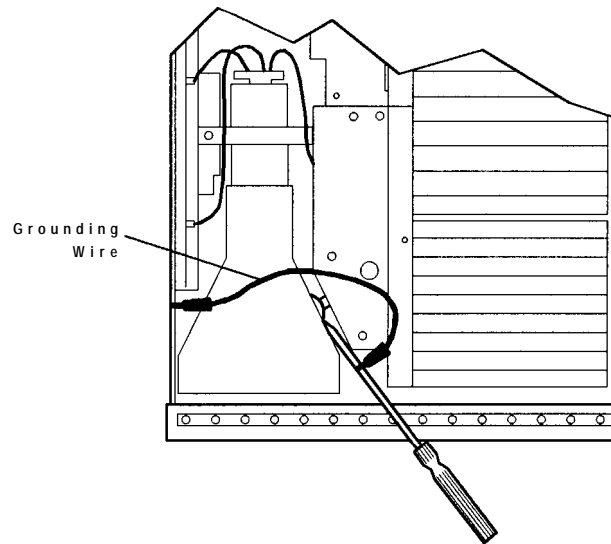

Figure 3-15. Discharging the CRT Post-Accelerator Cable

Note

A small bracket and screw secure the A1A3 High-Voltage Regulator Assembly to the A1A10 Display Motherboard Assembly. The bottom cover of the IF-Display Section must be removed to gain access to this screw prior to removal of the A1A3 High-Voltage Regulator Assembly.

3. Preliminary Display Adjustments (SN 3001A and Below)

Reference A1A1 Keyboard
 A1A2 Z-Axis Amplifier
 A1A4 X-Deflection Amplifier
 A1A5 Y-Deflection Amplifier

Note Adjustment 2, “High-Voltage Adjustment,” should be performed before performing the following adjustment procedure.

Note Perform this adjustment only if components have been replaced on the A1A2 Z-Axis Amplifier, A1A4 X-Deflection Amplifier, or A1A5 Y-Deflection Amplifier Assemblies. Components A1A2R22 HF GAIN, A1A2C10, A1A4R28 HF GAIN, A1A4C10, A1A4C11, A1A5R28 HF GAIN, A1A5C10, and A1A5C11 are factory adjusted and normally do not require readjustment.

Description The AI Display Section is adjusted to compensate the CRT drive circuits for proper horizontal and vertical characteristics. These preliminary adjustments are necessary only when a major repair has been performed in the display section (for example, replacement or repair of the A1A2 Z Axis Amplifier, A1A4 X-Deflection Amplifier, or A1A5 Y-Deflection Amplifier assemblies). For routine maintenance, CRT replacement, or minor repairs, only adjustment procedure 4, “Final Display Adjustments,” needs to be performed.

Caution Be sure not to allow a high intensity spot to remain on the spectrum analyzer CRT. A fixed spot of high intensity may permanently damage the CRT’s phosphor coating. Monitor the CRT closely during the following adjustment procedures. If a spot occurs, move it off-screen by adjusting either the front-panel INTENSITY control, or the horizontal or vertical deflection position controls.

Equipment Digitizing Oscilloscope HP 54501A
 Pulse/Function Generator HP 8116A
 10:1 Divider Probe, 10 MW7.5 pF (2 required) HP 10432A
 Display Adjustment PC Board (*service* accessory) 85662-60088
 Termination, BNC 50Ω HP 11593A

Adapters:
 Adapter, BNC tee 1250-0781
 Adapter, BNC(f) to SMB(f) 1250-1236

3. Preliminary Display Adjustments (SN 3001A and Below)

Procedure

X and Y Deflection Amplifier Pulse Response Adjustments

1. Connect a 10: 1 (10 M Ω) divider probe to the oscilloscope's channel 1 input and a 10:1 divider probe to the channel 4 input.
2. On the oscilloscope, press **RECALL** **CLEAR** to perform a soft reset.
3. On the oscilloscope, press **CHAN** more preset probe , select channel 1, and use the front-panel knob to select a 10: 1 probe.
4. Select channel 4, and use the front-panel knob to select a 10: 1 probe.
5. Press **SHOW**.
6. Connect the channel 1 probe to the oscilloscope rear panel PROBE COMPENSATION AC CALIBRATOR OUTPUT connector. Press **AUTO- SCALE**. Adjust the channel 1 probe for an optimum square wave display on the oscilloscope.
7. Connect the channel 4 probe to the oscilloscope rear panel PROBE COMPENSATION AC CALIBRATOR OUTPUT connector. Press **AUTO- SCALE**. Adjust the channel 4 probe for an optimum square wave display on the oscilloscope.

Note

Each probe is now compensated for the oscilloscope input to which it is connected. Do not interchange probes without recompensating.

8. Connect the channel 1 10:1 divider probe to A1A4E1, and the channel 4 probe to A1A4E2, as shown in Figure 3-16. Connect the probe ground leads to chassis ground. See Figure 3-17 and Figure 3-18 for the location of the assemblies and test points.

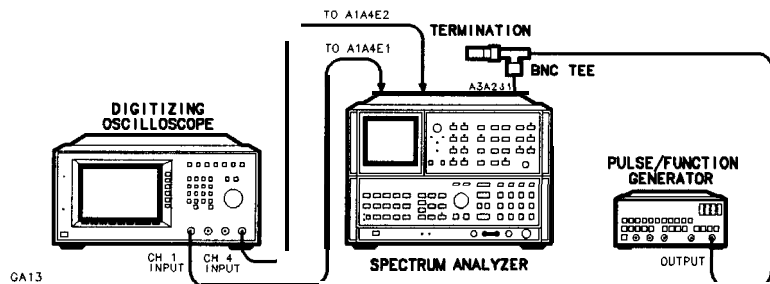

Figure 3-16. Preliminary Display Adjustments Setup

9. Set the spectrum analyzer LINE switch to STANDBY. Remove the cover over A3 Digital Storage Section and remove A3A2 Intensity Control Assembly. Insert the Display Adjustment PC board (HP part number 85662-60088) into the A3A2 slot. See Figure 3-17 for the location of the A3A2 assembly.

3. Preliminary Display Adjustments (SN 3001A and Below)

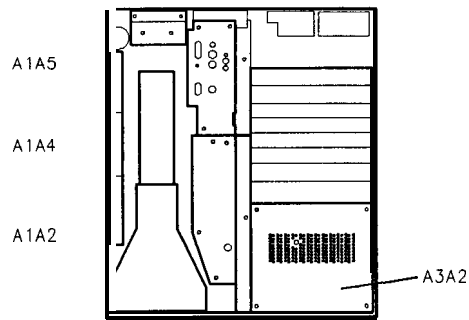

Figure 3-17. Location of A1A2, A1A4, A1A5, and A3A2

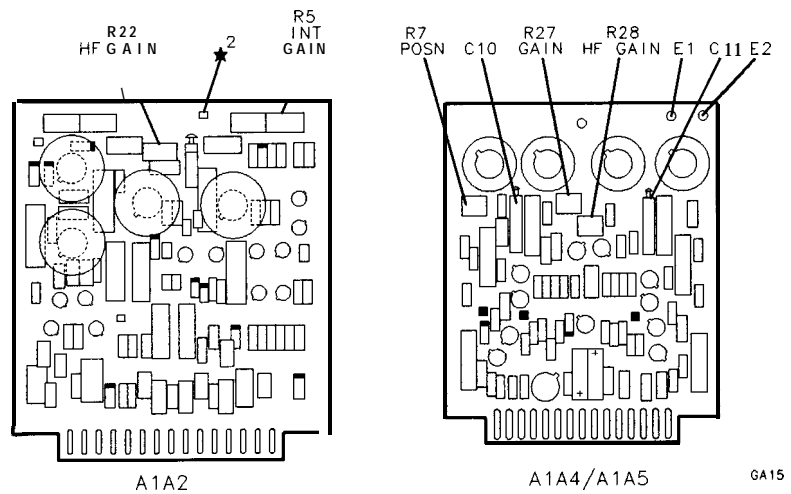

Figure 3-18. A1A2, A1A4, and A1A5 Adjustment Locations

10. Set the pulse/function generator controls as follows:

MODE	NORM
Waveform	pulse
Frequency (FRQ)	200 kHz
Width (WID)	250 ns
Amplitude (AMP)	2.00 V
Offset (OFS)000 mV
Disable	off (OUTPUT enabled)

11. Connect the output of the pulse/function generator to J1 (X input) on the Display Adjustment PC board in the A3A2 slot as shown in Figure 3-16.

Note

The pulse/function generator output must be terminated with 50 ohms. Use a BNC tee, a 500 termination, and a BNC female to SMB female adapter. Install the 50Ω termination as close to the Display Adjustment PC Board as possible.

3. Preliminary Display Adjustments (SN 3001A and Below)

12. Set the oscilloscope controls as follows:

Press **CHAN**:

Channel 1 on
 amplitude scale 10.0 V/div
 offset 25.0000 V
 Channel 4 on
 amplitude scale 10.0 V/div
 offset 60.0000 V

Press **TRIG**:

source
 level 25.0000 V

Press **TIME**:

time scale 50.0 ns/div
 delay 125.000 ns

Press **DISPLAY**:

connect dots on

Press **SHOW**.

13. Set the spectrum analyzer front-panel INTENSITY control fully counterclockwise, and then set the LINE switch to ON.

14. The X+ deflection and X- deflection waveforms should be superimposed on the oscilloscope display, as shown in Figure 3-19. If necessary, adjust A1A4R7 X POSN and A1A4R27 X GAIN for a centered display of at least four vertical divisions. See Figure 3-18 for the location of the adjustments.

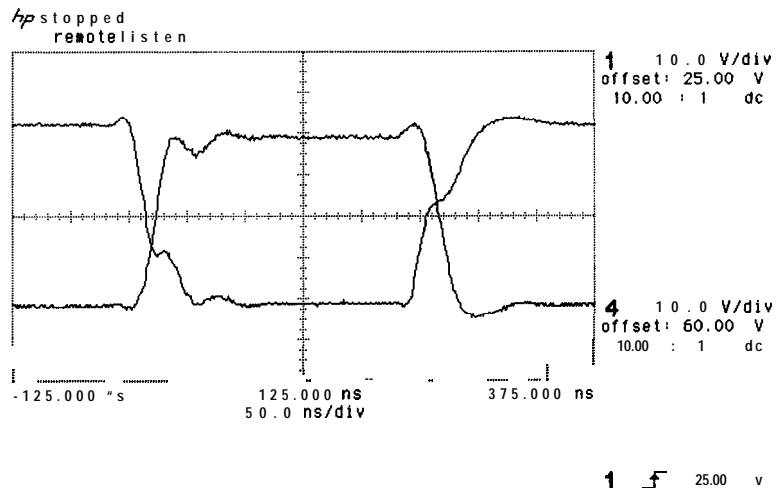

Figure 3-19. X + and X- Waveforms

15. Set the oscilloscope controls as follows:

Press **WFORM MATH**:

f1 on
 display on
 math channel 1 – channel 4
 sensitivity 25.0 V/div

16. Three waveforms should be displayed on the oscilloscope, as shown in Figure 3-20. The lower composite waveform represents

3. Preliminary Display Adjustments (SN 3001A and Below)

the combined X deflection voltage applied to the CRT. Use the oscilloscope front-panel knob to adjust waveform fl sensitivity for approximately 8 vertical divisions.

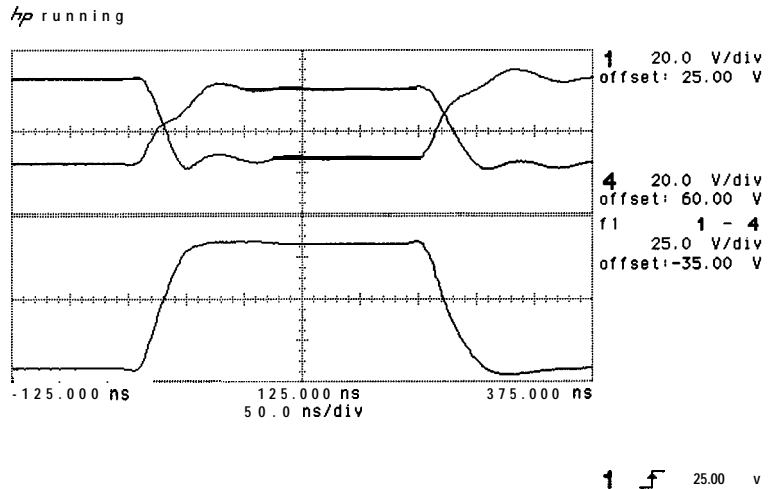

Figure 3-20. Composite X Deflection Waveform

- Adjust A1A4R28 HF GAIN, A1A4C10, and A1A4C11 for minimum overshoot and minimum rise and fall times of the composite X-deflection waveform. See Figure 3-18 for the location of the adjustments.

Note

Always adjust A1A4C10 and A1A4C11 in approximately equal amounts. Do not adjust one to its minimum value and the other to its maximum value.

- Use the oscilloscope $\Delta t \Delta V$ markers to measure the risetime, falltime, and percent overshoot of the composite Xdeflection waveform. Rise and fall times should both be less than approximately 65 ns between the 10% and 90% points on the waveform. Overshoot should be less than 3% (approximately 0.25 divisions). See Figure 3-21.

3. Preliminary Display Adjustments (SN 3001A and Below)

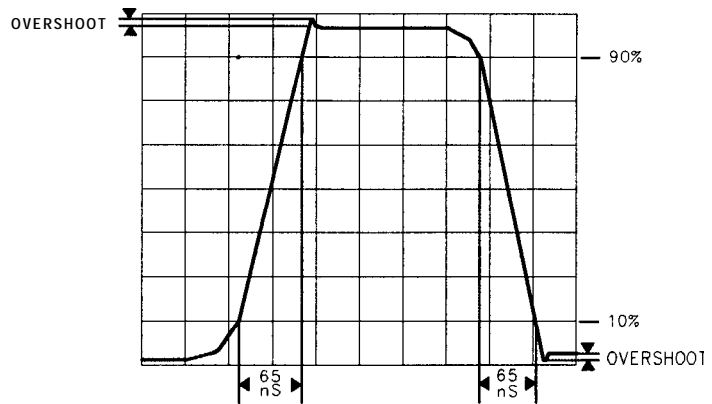

Figure 3-2 1.
Rise and Fall Times and Overshoot Adjustment Waveform

19. Connect the oscilloscope channel 1 probe to A1A5E1 and the channel 4 probe to A1A5E2. See Figure 3-18 for the location of the test points. Connect the output of the pulse/function generator to J2 (Y input) on the Display Adjustment PC board in the A3A2 slot.
20. The Y Deflection Amplifier is identical to the X Deflection Amplifier. Repeat steps 12 through 18 for the Y Deflection Amplifier using R7, R27, R28, C10, and C11 respectively.

Pulse Response of Control Gate Z Amplifier to BLANK Input

21. Disconnect the oscilloscope channel 4 probe from the spectrum analyzer. Connect the oscilloscope channel 1 probe to A1A2TP2, and connect the probe ground lead to chassis ground.
22. On the oscilloscope, press **RECALL**, **CLEAR** to perform a soft reset.
23. Press **CHAN**, **CHANNEL** 1 on, **more** preset probe , and use the front-panel knob to set the probe to 10.00:1. Press more .
24. Set the oscilloscope controls as follows:
 - Press **CHAN**:
 - amplitude scale 10.0 V/div
 - offset 25.0000 V
 - Press **TIME BASE**:
 - time scale 50.0 ns/div
 - delay 125.000 ns
 - Press **TRIG**:
 - level 5.00000 v
 - Press **DISPLAY**:
 - connect dots on
 - Press **SHOW**.
25. Connect the output of the pulse/function generator to J3 (Z input) on the Display Adjustment PC Board in the A3A2 slot. Set the board's switch to the *down* position.

3. Preliminary Display Adjustments (SN 3001A and Below)

Note

The pulse/function generator output must be terminated with 50 ohms. Use a BNC tee, a 50Ω termination, and a BNC female to SMB female adapter. Install the 50Ω termination as close to the Display Adjustment PC Board as possible.

26. Set the pulse/function generator controls as follows:

```

MODE ..... NORM
Waveform ..... pulse
Frequency (FRQ) ..... 200 kHz
Width (WID) ..... 250 ns
Amplitude (AMP) ..... 4.00V
Offset (OFS) ..... 2.00V
    
```

27. Set the spectrum analyzer front-panel INTENSITY control fully clockwise. Adjust the oscilloscope trigger level for a stable display. Note the display on the oscilloscope. The pulse should be $\geq 55V$ peak-to-peak.

28. Set the oscilloscope controls as follows:

```

Press CHAN:
Channel 1 ..... on
amplitude scale ..... 8.0V/div
Press SHOW.
    
```

29. Adjust A1A4R7 X POS and A1A5R7 Y POS to either extreme to position the CRT beam off-screen (to prevent possible damage to the CRT phosphor). If it is not sealed, adjust A1A2R5 INT GAIN fully clockwise.

30. Adjust the spectrum analyzer front-panel INTENSITY control for 50 V peak-to-peak (6.25 divisions) as indicated on the oscilloscope. See Figure 3-22.

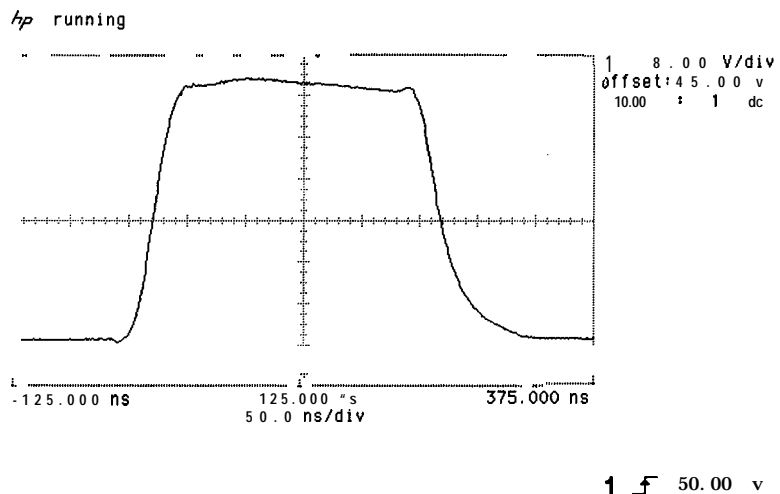

Figure 3-22. 50V_{p-p} Signal

31. Adjust A1A2R22 HF GAIN and A1A2C10 for minimum overshoot on rise and minimum rise and fall times of the pulse waveform.

3. Preliminary Display Adjustments (SN 3001A and Below)

32. Use the oscilloscope $\Delta t \Delta V$ markers to measure the risetime, falltime, and percent overshoot of the pulse waveform. Rise and falltimes should be less than 50 ns and 90 ns respectively. Overshoot on the rise should be less than 5% (approximately 0.4 divisions).
33. Set the spectrum analyzer LINE switch to STANDBY, and center potentiometers A1A4R7 X POSN and A1A5R7 Y POSN.
34. Disconnect the oscilloscope channel 1 probe from the spectrum analyzer. Remove the Display Adjustment PC board from the A3A2 slot, and reinstall the A3A2 Intensity Control Assembly. Replace the A3 Section cover and cables.
35. Perform Adjustment Procedure 4, Final Display Adjustment (SN 3001A and Below).

3. Preliminary Display Adjustments (SN 3004A and Above)

Reference A1A1 Keyboard
 A1A2 X, Y, Z Axis Amplifier

Note Adjustment Procedure 2, "High-Voltage Adjustment," should be performed before performing the following adjustment procedure.

Note Perform this adjustment only if components have been replaced on the A1A2 X, Y, Z Axis Amplifier Assembly. Components R117, R217, R308, C104, C109, C204, C209, and C307 are factory adjusted and normally do not require readjustment. Components affecting these adjustments are located in function blocks F, H, M, N, O, P, R, and S of the A1A2 X, Y, Z Axis Amplifier Assembly schematic diagram.

Description The X, Y, Z Axis Amplifier Assembly is adjusted to compensate the CRT drive circuits for proper horizontal and vertical characteristics. These preliminary adjustments are necessary only after replacement or repair of the A1A2 X, Y, Z Axis Amplifier Assembly). For routine maintenance, CRT replacement, or minor repairs, only Adjustment Procedure 4, "Final Display Adjustments," needs to be performed.

Caution Be sure not to allow a fixed spot of high intensity to remain on the spectrum analyzer CRT. A high intensity spot may permanently damage the CRT's phosphor coating. Monitor the CRT closely during the following adjustment procedures. If a spot occurs, move it off-screen by adjusting either the front-panel INTENSITY control, or the horizontal or vertical deflection position controls.

Equipment Digitizing Oscilloscope HP 54501A
 Pulse/Function Generator HP 8116A
 10: 1 Divider Probe, 10 M Ω /7.5 pF, (2 *required*) HP 10432A
 Display Adjustment PC Board (*service* accessory) 85662-60088
 Termination, BNC 50 Ω HP 11593A

Adapters:
 Adapter, BNC(f) to SMB(f) 1250-1236
 Adapter, BNC tee 1250-0781

3. Preliminary Display Adjustments (SN 3004A and Above)

Procedure

X and Y Deflection Amplifier Pulse Response Adjustments

1. Connect a 10: 1 (10 M Ω) divider probe to the oscilloscope's channel 1 input and a 10: 1 divider probe to the channel 4 input.
2. On the oscilloscope, press **RECALL** **CLEAR** to perform a soft reset.
3. On the oscilloscope, press **CHAN** more preset probe , select channel 1, and use the front-panel knob to select a 10: 1 probe.
4. Select channel 4, and use the front-panel knob to select a 10:1 probe.
5. Press **SHOW**.
6. Connect the channel 1 probe to the oscilloscope rear panel PROBE COMPENSATION AC CALIBRATOR OUTPUT connector. Press **AUTO-SCALE**. Adjust the channel 1 probe for an optimum square wave display on the oscilloscope.
7. Connect the channel 4 probe to the oscilloscope rear panel PROBE COMPENSATION AC CALIBRATOR OUTPUT connector. Press **AUTO-SCALE**. Adjust the channel 4 probe for an optimum square wave display on the oscilloscope.

Note

Each probe is now compensated for the oscilloscope input to which it is connected. Do not interchange probes without recompensating.

8. Connect the channel 1 10:1 divider probe to A1A2TP204, and the channel 4 probe to A1A2TP205, as shown in Figure 3-23. Connect the probe ground leads to A1A2TP106. See Figure 3-24 and Figure 3-25 for the location of the assemblies and test points.

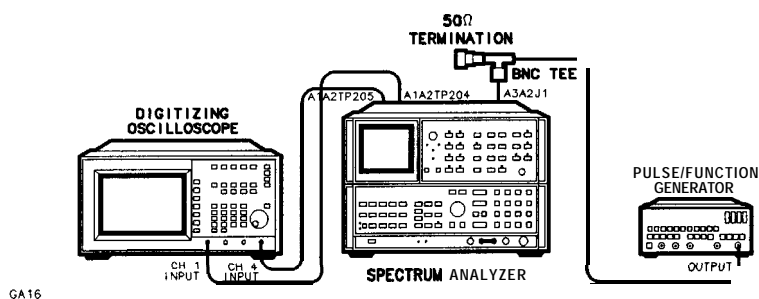

Figure 3-23. Preliminary Display Adjustments Setup

9. Set the spectrum analyzer LINE switch to standby. Remove the cover over A3 Digital Storage Section and remove A3A2 Intensity Control Assembly. Insert the Display Adjustment PC board (HP part number 85662-60088) into the A3A2 slot. See Figure 3-24 for the location of the A3A2 assembly.

3. Preliminary Display Adjustments (SN 3004A and Above)

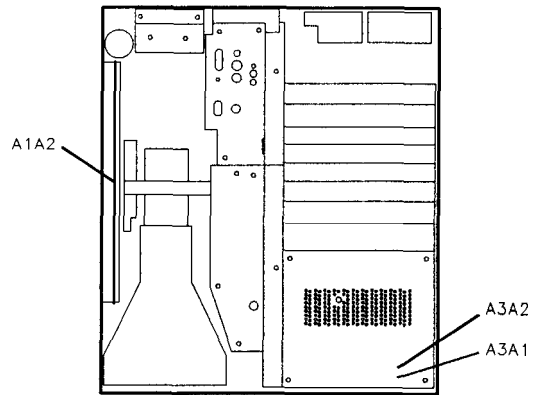

Figure 3-24. Location of A1A2 and A3A2

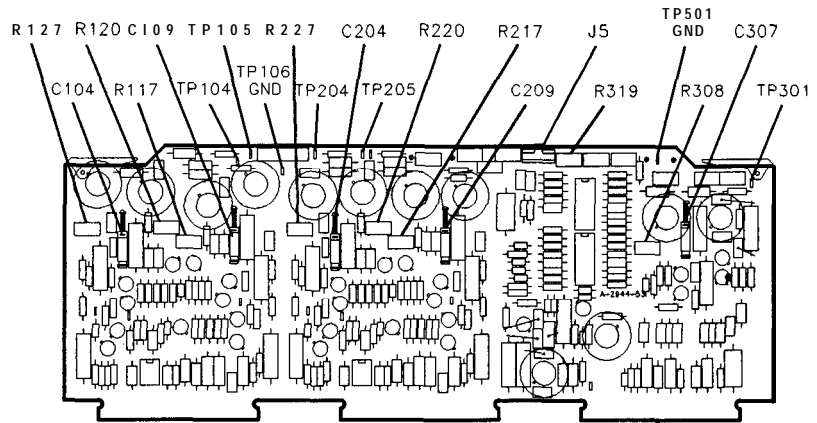

Figure 3-25. A1A2 Adjustment Locations

10. Set the pulse/function generator controls as follows:

MODE	NORM
Waveform	pulse
Frequency (FRQ)	200 kHz
Width (WID)	250 ns
Amplitude (AMP)	2.00 V
Offset (OFS)	0.000 mV
Disable	off (OUTPUT enabled)

11. Connect the output of the pulse/function generator to J1 (X input) on the Display Adjustment PC board in the A3A2 slot as shown in Figure 3-23.

Note

The pulse/function generator output must be terminated with 50 ohms. Use a BNC tee, a 500 termination, and a BNC female to SMB female adapter. Install the 500 termination as close to the Display Adjustment PC Board as possible.

3. Preliminary Display Adjustments (SN 3004A and Above)

12. Set the oscilloscope controls as follows:

Press **CHAN**:

Channel 1 on
 amplitude scale 10.0 V/div
 offset 25.0000 V
 Channel 4 on
 amplitude scale 10.0 V/div
 offset 60.0000 V

Press (TRIG):
 source 1
 level 25.0000 V

Press **TIME BASE**:
 time scale 50.0 ns/div
 delay 125.000 ns

Press **DISPLAY**:
 connect dots on

Press **SHOW**.

13. Set the spectrum analyzer front-panel INTENSITY control fully counterclockwise, and then set the LINE switch to ON.

14. The X+ deflection and X- deflection waveforms should be superimposed on the oscilloscope display, as shown in Figure 3-26. If necessary, adjust A1A2R227 X POSN and A1A2R220 X GAIN for a centered display of at least four vertical divisions. See Figure 3-25 for the location of the adjustments.

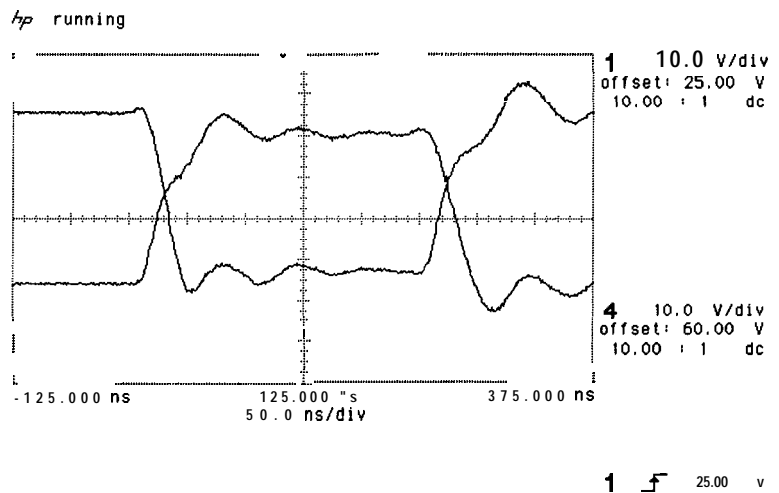

Figure 3-26. X+ and X- Waveforms

15. Set the oscilloscope controls as follows:

Press **WFORM MATH**:

f1 on
 display on
 math channel 1 – channel 4
 sensitivity 25.0 V/div

16. Three waveforms should be displayed on the oscilloscope, as shown in Figure 3-27. The lower composite waveform represents

3. Preliminary Display Adjustments (SN 3004A and Above)

the combined X deflection voltage applied to the CRT. Use the oscilloscope front-panel knob to adjust waveform fl sensitivity for approximately 8 vertical divisions.

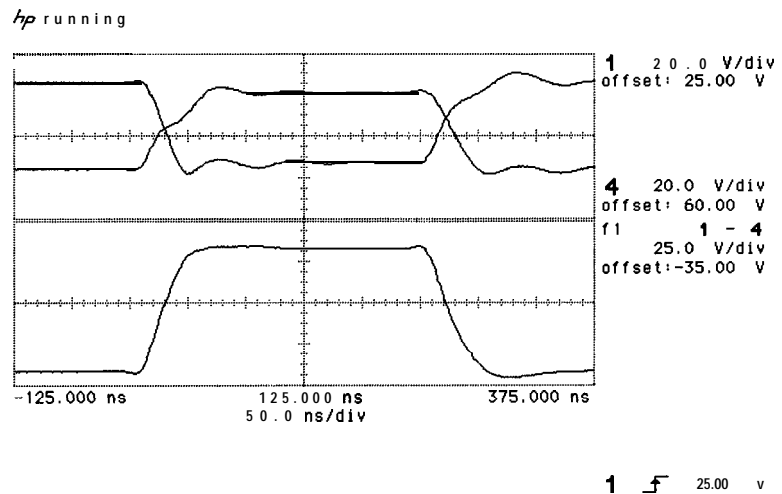

Figure 3-27. Composite X Deflection Waveform

- Adjust A1A2R217 HF GAIN, A1A2C204, and A1A2C209 for minimum overshoot and minimum rise and fall times of the composite Xdeflection waveform.

Note

Always adjust A1A2C204 and A1A2C209 in approximately equal amounts. Do not adjust one to its minimum value and the other to its maximum value.

- Use the oscilloscope $\Delta t \Delta V$ markers to measure the risetime, falltime, and percent overshoot of the composite Xdeflection waveform. Rise and fall times should both be less than approximately 65 ns between the 10% and 90% points on the waveform. Overshoot should be less than 3% (approximately 0.25 divisions). See Figure 3-28.

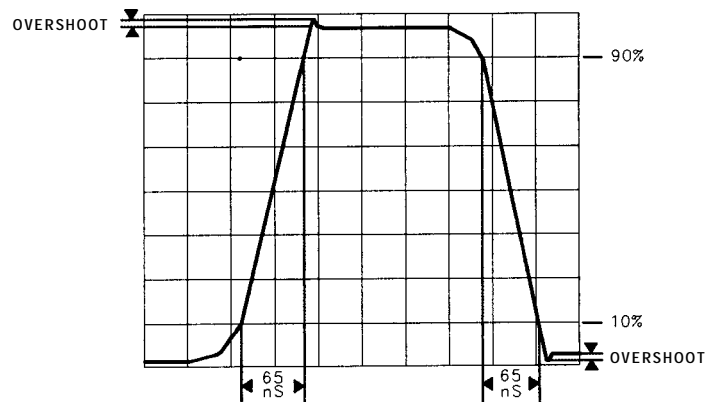

Figure 3-28. Rise and Fall Times and Overshoot Adjustment Waveform

3. Preliminary Display Adjustments (SN 3004A and Above)

19. Connect the oscilloscope channel 1 probe to A1A2TP104 and the channel 4 probe to A1A2TP105. See Figure 3-25 for the location of the test points. Connect the output of the pulse/function generator to J2 (Y input) on the Display Adjustment PC board in the A3A2 slot.
20. The Y Deflection Amplifier is identical to the X Deflection Amplifier. Repeat steps 12 through 18 for the Y Deflection Amplifier using R127, R120, R117, C104, and C109, respectively.

Pulse Response of Control Gate Z Amplifier to BLANK Input

21. Disconnect the oscilloscope channel 4 probe from the spectrum analyzer. Connect the oscilloscope channel 1 probe to A1A2TP301, and connect the probe ground lead to A1A2TP501.
22. On the oscilloscope, press **RECALL** **CLEAR** to perform a soft reset.
23. Press **CHAN**, **CHANNEL 1** on, more preset probe, and use the front-panel knob to set the probe to 10.00:1. Press more .
24. Set the oscilloscope controls as follows:
 - Press **CHAN**:
 - amplitude scale 20.0 V/div
 - offset 45.0000 V
 - Press **TIME BASE**:
 - time scale 50.0 ns/div
 - delay 125.000 ns
 - Press (TRIG):
 - level 50.00000 V
 - Press **DISPLAY**:
 - connect dots on
 - Press **SHOW**.
25. Connect the output of the Pulse/Function Generator to J3 (Z input) on the Display Adjustment PC Board in the A3A2 slot. Set the board's switch to the *down* position.

Note

The pulse/function generator output must be terminated with 50 ohms. Use a BNC tee, a 50Ω termination, and a BNC female to SMB female adapter. Install the 50Ω termination as close to the Display Adjustment PC Board as possible.

26. Set the pulse/function generator's controls as follows:
 - MODE NORM
 - Waveform pulse
 - Frequency (FRQ) 200 kHz
 - Width (WID) 250 ns
 - Amplitude (AMP) 4.00V
 - Offset (OFS) 2.00V
27. Disconnect the black connector with three wires (8, 98, and 96) from A1A2J5, and set A1A2R319 INT GAIN fully clockwise.
28. Set the spectrum analyzer front-panel INTENSITY control fully clockwise. Adjust the oscilloscope trigger level for a stable display. Note the display on the oscilloscope. The pulse should be ≥55V peak-to-peak.

3. Preliminary Display Adjustments (SN 3004A and Above)

29. Set the oscilloscope controls as follows:

Press **CHAN**:

Channel 1 on
amplitude scale 8.00 V/div

Press **SHOW**.

30. Adjust the spectrum analyzer front-panel INTENSITY control for 50 V peak-to-peak (6.25 divisions) as indicated on the oscilloscope. See Figure 3-29.

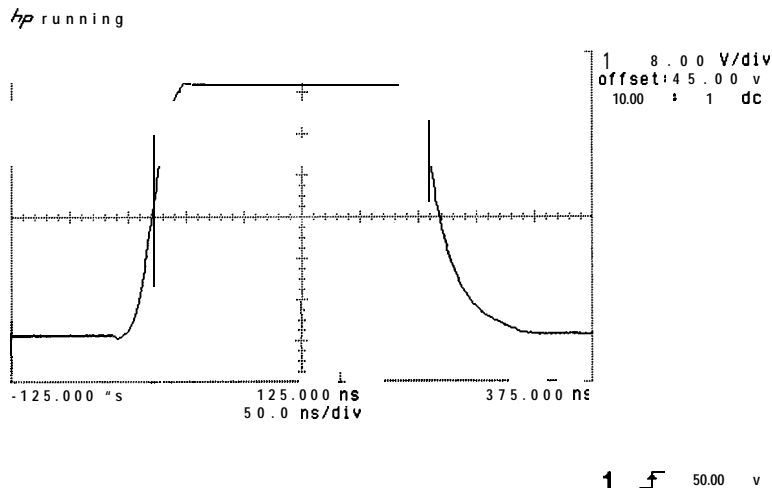

Figure 3-29. 50V_{p-p} Signal

31. Adjust A1A2R308 HF GAIN and A1A2C307 for minimum overshoot on rise and minimum rise and fall times of the pulse waveform.
32. Use the oscilloscope **ΔtΔV** markers to measure the risetime, falltime, and percent overshoot of the pulse waveform. Rise and falltimes should be less than 50 ns and 90 ns respectively. Overshoot on the rise should be less than 5% (approximately 0.4 divisions).
33. Set the spectrum analyzer LINE switch to STANDBY.
34. Disconnect the oscilloscope channel 1 probe from the spectrum analyzer. Remove the Display Adjustment PC board from the A3A2 slot, and reinstall the A3A2 Intensity Control Assembly. Replace the A3 Section cover and cables.
35. Reconnect the black connector with three wires (8, 98, and 96) to A1A2J5, and set A1A2R319 INT GAIN approximately two-thirds clockwise.
36. Perform Adjustment Procedure 4 Final Display Adjustment (SN 3004A and Above).

4. Final Display Adjustments (SN 3001A and Below)

Reference A1A1 Keyboard
 A1 A2 Z Axis Amplifier
 A1A4 X Deflection Amplifier
 A1A5 Y Deflection Amplifier

Description This procedure is used to optimize the appearance of the CRT display during routine maintenance or after CRT replacement or minor repairs. First, the display is adjusted for best focus over the full CRT, then the graticule pattern is adjusted for optimum rectangular display.

Note Adjustment Procedure 2, High Voltage Adjustment (SN 3001A and Below) should be performed prior to performing the following adjustment procedure.

Procedure 1. With the spectrum analyzer LINE switch set to STANDBY, set the potentiometers listed in Table 3-5 as indicated. See Figure 3-30 for the location of the adjustments.

Note In this procedure, do not adjust the following potentiometers and precision variable capacitors on the A1A2 Z-Axis Amplifier, A1A4 X-Axis Amplifier, or A1A5 Y-Axis Amplifier Assemblies: A1A2R36 INT LIMIT, A1A2R22 HF GAIN, A1A2C10, A1A4R28 HF GAIN, A1A4C10, A1A4C11, A1A5R28 HF GAIN, A1A5C10, or A1A5C11. These components are adjusted in Adjustment Procedure 2, High Voltage Adjustments (SN 3001A and Below) and Adjustment Procedure 3, Preliminary Display Adjustments (SN 3001A and Below).

Table 3-5. Initial Adjustment Positions

Adjustment	Position
Front-panel INTENSITY	fully clockwise
Front-panel FOCUS	centered
Front-panel ALIGN	centered
A1A2R5 INT GAIN	fully clockwise

- Set the spectrum analyzer LINE switch to ON and wait at least 5 minutes to allow the CRT and high-voltage circuits to warm up. The spectrum analyzer power-up annotation should be visible on the CRT display.
- For an initial coarse focus adjustment, adjust A1A3R15 FOCUS LIMIT, A1A2R36 ASTIG, and A1A2R30 FOCUS GAIN in sequence for best displayed results.
- Adjust A1A4R7 X POSN, A1A4R27 X GAIN, A1A5R7 Y POSN, and A1A5R27 Y GAIN for optimum centering of the display annotation and graticule pattern.

4. Final Display Adjustments (SN 3001A and Below)

5. For best overall focusing of the display, adjust the following potentiometers in the sequence listed below:
 - a. A1A3R14 FOCUS LIMIT for best focus of graticule lines (long vectors)
 - b. A1A2R36 ASTIG
 - c. A1A2R30 FOCUS GAIN for best focus of annotation (short vectors)
6. Adjust A1A2R31 ORTHO, the front-panel ALIGN control, and A1A2R32 PATT to optimize the orientation and appearance of the rectangular graticule pattern on the CRT display.
7. Repeat steps 4 through 6 as needed to optimize overall display focus and appearance.

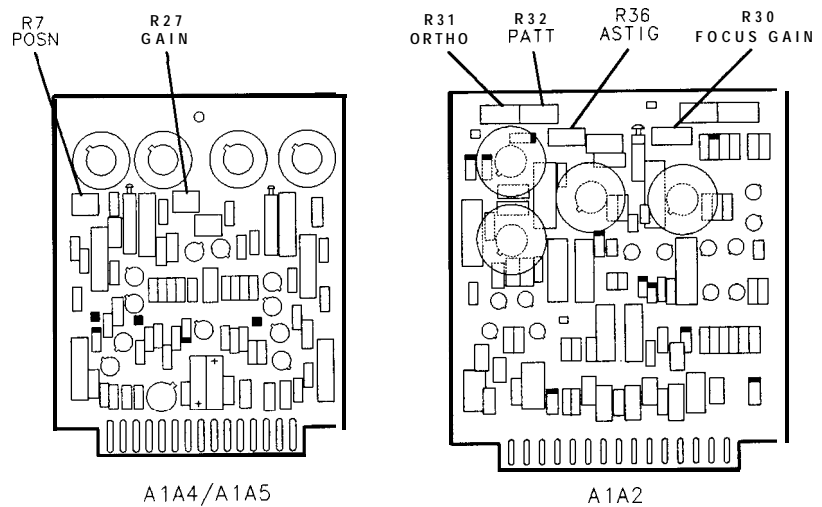

Figure 3-30.
Location of Final Display Adjustments on A1A2, A1A4, and A1A5

4. Final Display Adjustments (SN 3004A and Above)

Reference A1A1 Keyboard
A1A2 X, Y, Z Axis Amplifiers

Description This procedure is used to optimize the appearance of the CRT display during routine maintenance or after CRT replacement or minor repairs. First, the display is adjusted for best focus over the full CRT, then the graticule pattern is adjusted for optimum rectangular display.

Equipment Digital Photometer Tektronix J-16, Option 02
Photometer Probe Tektronix 56503
Photometer interconnect cable Tektronix 012-0414-02
Photometer light occluder Tektronix 016-0305-00

Procedure

Note Adjustment Procedure 2, High Voltage Adjustment (SN 3004A and Above) should be performed prior to performing the following adjustment procedure.

1. Connect the equipment as shown in Figure 3-31.

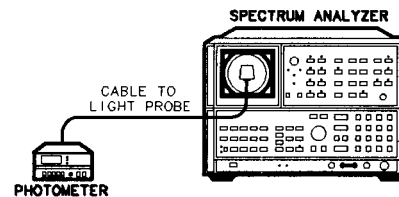

Figure 3-31. Final Display Adjustments Setup

2. Set the photometer probe to NORMAL. Press **POWER** on the photometer to turn it on and allow 30 minutes warm-up. Zero the photometer according to the manufacturer's instructions.
3. With the spectrum analyzer LINE switch set to STANDBY, set the potentiometers listed in the Table 3-6 as indicated. See Figure 3-32 for the location of the adjustments.

Note In this procedure, do not adjust the following potentiometers and variable capacitors on the A1A2 X, Y, Z Amplifier Assembly: C104, C109, C204, C209, C307, R117, R217, or R308. These components are adjusted in the factory and in Adjustment Procedure 3, Preliminary Display Adjustments (SN 3004A and Above).

4. Final Display Adjustments (SN 3004A and Above)

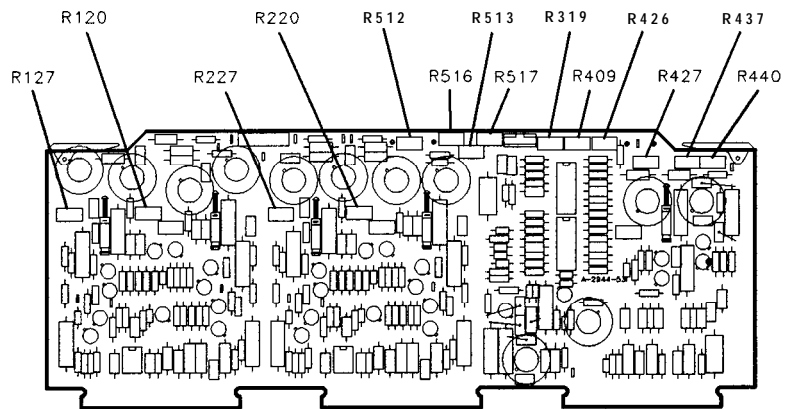

Figure 3-32. Location of Final Display Adjustments on A1A2

Table 3-6. Initial Adjustment Positions

Adjustment	Position
A1A2 R120 Y GAIN	centered
A1A2 R127 Y POSN	centered
A1A2 R220 X GAIN	centered
A1A2 R227 X POSN	centered
A1A2 R319 INT GAIN	two-thirds clockwise
A1A2 R409 FOCUS COMP	centered
A1A2 R426 T/B FOC	centered
A1 A2 R427 T/B CTR	centered
A1A2 R437 R/L FOC	centered
A1 A2 R440 R/L CTR	centered
A1A2 R512 ORTHO	centered
A1A2 R513 3D	centered
A1A2 R516 INT LIM	fully counterclockwise
A1A2 R517 ASTIG	centered
Front-panel INTENSITY	fully counterclockwise
Front-panel FOCUS	centered
Front-panel ALIGN	centered

4. Set the spectrum analyzer's LINE switch to ON, and wait at least 5 minutes to allow the CRT and high-voltage circuits to warm up.
5. Set the front panel INTENSITY control fully counterclockwise and adjust A1A2R516 INT LIM until the display is just visible. See Figure 3-32.
6. Set the front-panel INTENSITY control fully clockwise.
7. Adjust A1A2R220 X GAIN, A1A2R227 X POSN, A1A2R120 Y GAIN, and A1A2R127 Y POSN for optimum centering of the display annotation and graticule pattern.
8. For an initial coarse focus, adjust the following potentiometers in the sequence listed:

A1A3R14 FOCUS LIMIT

4. Final Display Adjustments (SN 3004A and Above)

A1A2R517 ASTIG
A1A2R513 3D
A1A2R409 FOCUS COMP

9. Press **0--2.5 GHz**, **REFERENCE LEVEL** and then adjust the reference level to bring the displayed noise to the top division of the graticule (**REFERENCE LEVEL**). Press **ENTER dB/DIV** and key in 1 dB/DIV. The noise should now completely fill the CRT graticule pattern, illuminating a large rectangular area. If necessary, adjust the reference level until the graticule pattern is completely filled.
10. Press SWEEP **SINGLE**, **SHIFT** DISPLAY LINE **OFF**^m, and then **SHIFT** THRESHOLD **OFF**^p to turn off the CRT annotation and graticule pattern.

Connect a 56503 photometer probe to the Tektronix J-16 digital photometer. Set the photometer to the XI range.

11. Place the photometer light probe hood against the IF-Display Section glass RFI filter, and adjust A1A2R319 INT GAIN for a photometer reading of 80 NITS (cd/m²).

Note

This reading must be made with the glass RFI filter in place in front of the CRT. It might be necessary to slightly trim the top and bottom of the photometer probe's hood so that it will fit flush against the glass RFI filter.

Note

If a standard J-16 photometer is used (instead of metric option 02), adjust A1A2R319 for a photometer reading of 23.5 fl (foot-lamberts).

12. Set the spectrum analyzer LINE switch to STANDBY and then back to ON. The spectrum analyzer power-up annotation should be visible on the CRT display. (This includes the firmware datecode.)
13. For the best focus near the center of the CRT display, adjust the following potentiometers in the sequence listed below. Repeat as needed to optimize center-screen focus.
A1A3R14 FOCUS LIMIT
A1A2R517 ASTIG
A1A2R513 3D for best focus of annotation (short vectors)
A1A2R409 FOCUS COMP for best focus of graticule lines (long vectors)
14. Adjust A1A2R426 T/B FOC for best focus at the top and bottom of the display.
15. Adjust A1A2R437 R/L FOC for best focus at the right and left sides of the display.
16. If the top and bottom (or right and left sides) of the display achieve best focus at different potentiometer settings, adjust A1A2R427 T/B CTR or A1A2R440 R/L CTR, and then readjust A1A2R426 T/B FOC or A1A2R437 R/L FOC to optimize overall focus.

4. Final Display Adjustments (SN 3004A and Above)

17. Adjust A1A2R512 ORTHO and the front-panel ALIGN control to optimize the orientation and appearance of the rectangular graticule pattern on the CRT display.
18. Repeat steps 13 through 17 as needed to optimize overall display focus and appearance.

5. Log Amplifier Adjustments

Reference IF-Display Section
 A4A3 Log Amplifier-Filter
 A4A2 Log Amplifier-Detector

Related Performance Tests Scale Fidelity Test

Note The A4A3 Log Amplifier-Filter and A4A2 Log Amplifier Detector are temperature compensated as a matched set at the factory. In the event of a circuit failure, a new matched set must be ordered. Contact your nearest HP Service Center.

Description The A4A2 Log Amplifier-Detector ZERO adjustment is checked and adjusted if necessary, then the A4A3 Log Amplifier-Filter is set for center frequency by injecting a signal and adjusting the bandpass filter center adjustment for maximum DVM indication. The bandpass filter amplitude is adjusted by monitoring the output of the filter control line shorted and not shorted to the + 15V supply. Next, log fidelity (gain and offset of the log curve) is adjusted by adjusting the -12 VTV and the PIN diode attenuator. Last, the linear gain step adjustments are performed to set the proper amount of step gain in the linear mode of operation.

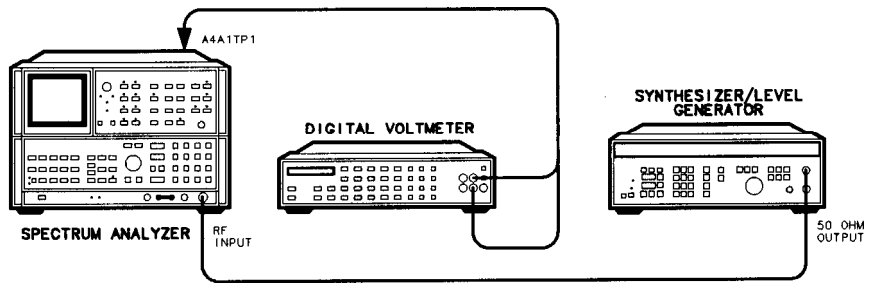

Figure 3-33. Log Amplifier Adjustments Setup

Equipment Digital Voltmeter (DVM) HP 3456A
 Frequency Synthesizer HP 3335A

5. Log Amplifier Adjustments

Procedure

1. Position the spectrum analyzer upright as shown in Figure 3-33. Remove the IF-Display section top cover.
2. Set spectrum analyzer LINE switch to ON and press **2-22 GHz**.

Offset Adjustment Check

3. Key in **FREQUENCY SPAN** 0 Hz, **CENTER FREQUENCY** 7.6 MHz, **REFERENCE LEVEL** + 10 dBm, **RES BW** 10 kHz, and press LIN pushbutton.
4. Connect DVM to A4A1TP1 and DVM ground to the IF casting. Connect the frequency synthesizer to the RF INPUT. Key in **FREQUENCY** 80 MHz and **AMPLITUDE** -86.98 dBm. The frequency synthesizer provides a 50Ω load to the spectrum analyzer RF INPUT.
5. Check A4A2R79 ZERO for a DVM indication of 0.0000 f0.0005 V dc. See Figure 3-34 for location of adjustment. If A4A2R79 ZERO requires adjustment, perform Adjustment Procedure 6, "Video Processor Adjustment" before continuing.

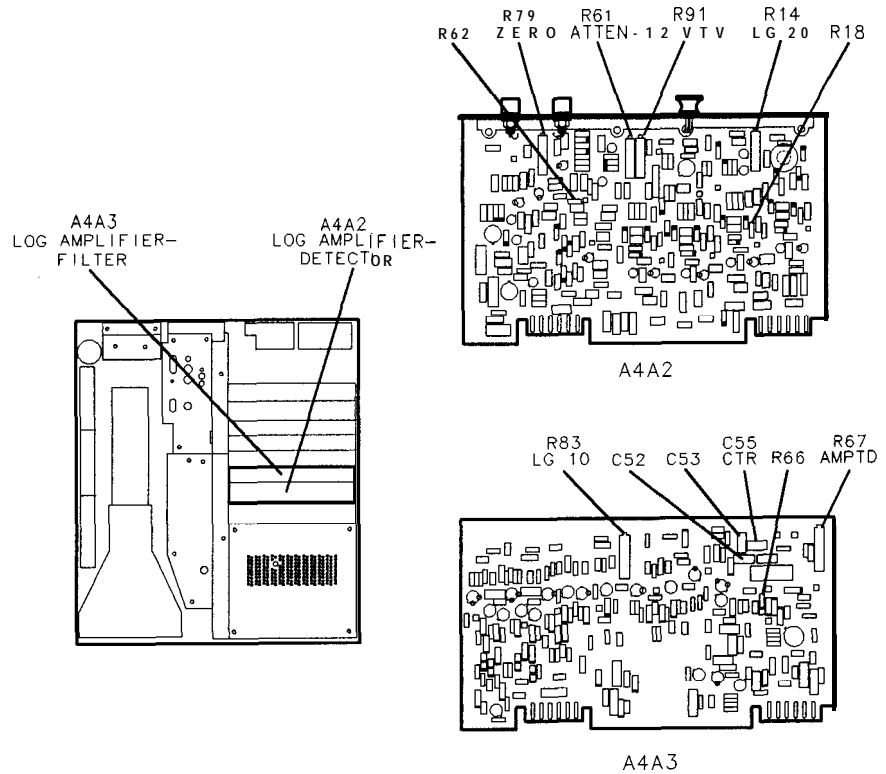

Figure 3-34. Location of Log Amplifier Adjustments

**Bandpass Filter
Center Adjustment**

6. Press LOG CENTER dB/DIV.
7. Set the frequency synthesizer for 7.6000 MHz at +5.0 dBm output level.
8. Adjust A4A3C55 CTR for maximum DVM indication. See Figure 3-34 for location of adjustment. If A4A3C55 is at an extreme of its adjustment range (fully meshed, maximum capacitance, or unmeshed, minimum capacitance), increase or decrease value of A4A3C52 and A4A3C53. Refer to Table 3-3 for range of values.

Note

A4A3C52 is a fine adjustment, and A4A3C53 is a coarse adjustment. If A4A3C55 is fully meshed, increase the value of A4A3C52 or A4A3C53.

**Bandpass Filter
Amplitude Adjustment**

9. Connect one end of a jumper wire to A4A3TP8. Connect the other end of the jumper to A4A3TP7 (+15V). Connecting the jumper to A4A3TP8 first reduces the chance of shorting the +15V to ground. Note DVM indication.

_____ V dc

10. Remove the jumper from between A4A3TP7 and A4A3TP8.
11. Adjust A4A3R67 AMPTD for DVM indication the same as that noted in step 9 ± 0.0005 V dc. See Figure 3-34 for location of adjustment. If unable to adjust A4A3R67 AMPTD for proper indication, increase or decrease value of A4A3R66. (If A4A3R67 is fully counter-clockwise, increase the value of A4A3R66.)
Refer to Table 3-3 for range of values.
12. Repeat steps 9 through 11 until DVM indication is the same ± 0.0005 V dc with A4A3TP7 jumpered to A4A3TP8, and with A4A3TP7 and A4A3TP8 not jumpered. Remove the jumper.

**-12 VTV and ATTEN
Adjustments**

13. Press the LIN pushbutton.
14. Adjust frequency synthesizer output level for DVM indication of +1.000 ± 0.0002 V dc, and note the frequency synthesizer amplitude setting.

Frequency Synthesizer output level: _____ dBm

15. Press LOG ENTER dB/DIV.
16. Wait three minutes for the A4A3 Log Amplifier-Filter and A4A2 Log Amplifier Detector to stabilize.
17. Decrease the frequency synthesizer output level by 50 dB.
18. Adjust A4A2R91 -12 VTV for DVM indication of +500 ± 1 mV dc. See Figure 3-34 for location of adjustment.
19. Increase the frequency synthesizer output level by 50 dB (to the level of step 14).

5. Log Amplifier Adjustments

20. Adjust **A4A2R61 ATTEN** for DVM indication of + 1.000 fO.OOO1 V dc. See Figure 3-34 for location of adjustment. If unable to adjust **A4A2R61 ATTEN** for proper indication, increase or decrease value of **A4A2R62**. (If **A4A2R61** is fully clockwise, increase the value of **A4A2R62**.) Refer to **Table 3-3** for range of values.
21. Repeat steps 17 through 20, until specifications of steps 18 and 20 are achieved without further adjustment. Because adjustments **A4A2R61** and **A4A2R91** are interactive, several iterations are needed.

Linear Gain Adjustments

22. Press the LIN pushbutton. DVM indication at **A4A1TP1** should be + 1.000 ±0.020 V dc (+0.980 to + 1.020 V dc). If indication is not within this range, repeat steps 14 through 21. If indication is within this range, press **(SHIFT) (ENTER dB/DIV)**⁹. This disables the IF step gains.
23. Decrease the frequency synthesizer output level 10 dB. Press **(REFERENCE LEVEL) 0 dBm**, and adjust the frequency synthesizer output level for a DVM indication of + 1.00 f.OO1 Vdc.
24. Verify that attenuator is set at 10 dB. Decrease the frequency synthesizer output level by 10 dB. Press **(REFERENCE LEVEL) -60 dB**.
25. Adjust **A4A3R83 LG10** for DVM indication of + 1.000 fO.O10 V dc. See Figure 3-34 location of adjustment. If unable to adjust **LG10** for proper indication, increase or decrease value of **A4A3R54**. Refer to **Table 3-3** for range of values.
26. Decrease the frequency synthesizer output level by 10 dB.
27. Key in **(REFERENCE LEVEL) -70 dB**.
28. Adjust **A4A2R14 LG20** for DVM indication of + 1.000 fO.O10 V dc. See Figure 3-34 for location of adjustment. If unable to adjust **LG20** for proper indication, increase or decrease value of **A4A2R18**. Refer to **Table 3-3** for range of values.
29. Press **(2-22 GHz)** to reenble the IF step gains.

6. Video Processor Adjustments

Reference IF-Display Section
A4A1 Video Processor

Related Performance Test Log Scale Switching Uncertainty Test

Description The CAL OUTPUT signal is connected to the RF INPUT through a step attenuator. The instrument is placed in zero frequency span to produce a dc level output from the log amplifier. The A4A2R79 ZERO adjustment, which sets the dc offset of the output buffer amplifier of the log board, is checked and adjusted if necessary. The dc level into the video processor is adjusted by varying the input signal level and reference level. The offsets and gains on the A4A1 Video Processor are adjusted for proper levels using a DVM.

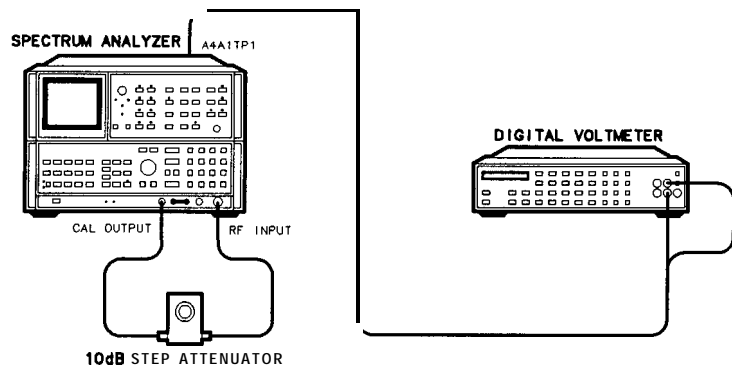

Figure 3-35. Video Processor Adjustments Setup

Equipment Digital Voltmeter (DVM) HP 3456A
10 dB Step AttenuatorHP 355D

Note The voltage at A4A1TP3 may drift noticeably with temperature during this adjustment. Allow the A4A1 Video Processor to warm up at least one-half hour prior to adjustment.

- Procedure**
1. Position the spectrum analyzer upright as shown in Figure 3-35. Remove the IF-Display Section top cover.
 2. Set the spectrum analyzer LINE switch to ON and press **2-22 GHz**.
 3. Connect DVM to A4A1TP1 and DVM ground to the IF casting.
 4. Connect CAL OUTPUT to RF INPUT through 10 dB step attenuator.
 5. Key in **[CENTER FREQUENCY]** 100 MHz and **[FREQUENCY SPAN]** 0 Hz. Press the LIN pushbutton.

6. Video Processor Adjustments

6. Set step attenuator to 120 dB. DVM indication should be 0.0000 f0.0005 V dc. If DVM indication is out of tolerance, adjust **A4A2R79 ZERO** on A4A2 Log Amplifier-Detector. See Figure 3-34 for the adjustment location.
7. Set the step attenuator to 0 dB.
8. Key in REFERENCE LEVEL and adjust DATA knob, and then the front panel AMPTD CAL control, for DVM indication as close to + 1.000 f0.001 Vdc as possible.
9. Connect DVM to **A4A1TP2**.
10. Adjust **A4A1R14 OS** for a DVM indication of 0.000 ± 0.003 Vdc. See Figure 3-36 for the location of the adjustment.

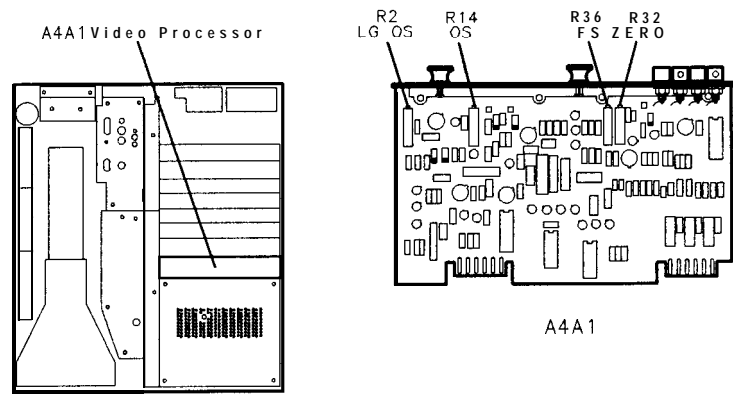

Figure 3-36. Location of Video Processor Adjustments

11. Connect the DVM to **A4A1TP3**.
12. Set the step attenuator to 120 dB.
13. Adjust **A4A1R32 ZERO** for a DVM indication of 0.000 f0.001 Vdc.
14. Set the step attenuator to 0 dB.
15. Adjust **A4A1R36 FS** for DVM indication of $+2.000 \pm 0.001$ Vdc.
16. Repeat steps 12 through 15 until no further adjustments are required.

LOG Offset Adjust

17. Set step attenuator to 40 dB.
18. Key in **(SHIFT), (ATTEN)**¹, LOG **(ENTER dB/DIV), (SHIFT) (ENTER dB/DIV)**⁹, REFERENCE LEVEL -50 dBm.
19. Connect DVM to **A4A1TP1**. Record DVM indication. Indication should be approximately +0.500 Vdc.
_____ Vdc
20. Decrease reference level to -60 dBm using the step key.
21. Adjust **A4A1R2 LG OS** for DVM indication of +0.100 f0.001 Vdc greater than the DVM indication recorded in step 19. See Figure 3-36 for location of adjustment.

6. Video Processor Adjustments

22. Decrease reference level to -70 dBm using the step key.
23. DVM indication should be $+0.200 \pm 0.002$ V dc greater than the indication recorded in step 19. If not, readjust A4A1R2 LG OS.
24. Decrease reference level to -90 dBm using the step key.
25. DVM indication should be $+0.400 \pm 0.004$ V dc greater than the indication recorded in step 19. If not, readjust A4A1R2 LG OS.
26. Repeat steps 17 through 25 until no further adjustments are required.

7. 3 MHz Bandwidth Filter Adjustments

Reference IF-Display Section
A4A7 3 MHz Bandwidth Filter

Related Performance Test Resolution Bandwidth Switching Uncertainty Test
Resolution Bandwidth Selectivity Test

Description With the CAL OUTPUT signal connected to the RF INPUT, the 18.4 MHz oscillator is adjusted with the FREQ ZERO control (on the front panel) to peak the IF signal for maximum amplitude for the center of the 3 MHz bandpass. Each of the five stages of the 3 MHz Bandwidth Filter is adjusted for **bandpass** centering and symmetry. Four crystal filter bypass networks are required for alignment of the filter stages. See Figure 3-109 or information concerning the bypass networks.

A stable 21.4 MHz signal is then applied to the IF section of the instrument from a frequency synthesizer. Each of the first four stages of the 3 MHz Bandwidth Filter is peaked in a 10 Hz bandwidth using an oscilloscope display. The final stage is peaked using the spectrum analyzer CRT display.

After all five filter stages are adjusted for centering, symmetry, and peaking, the CAL OUTPUT signal is used to match the 10 Hz and 1 kHz bandwidth amplitudes.

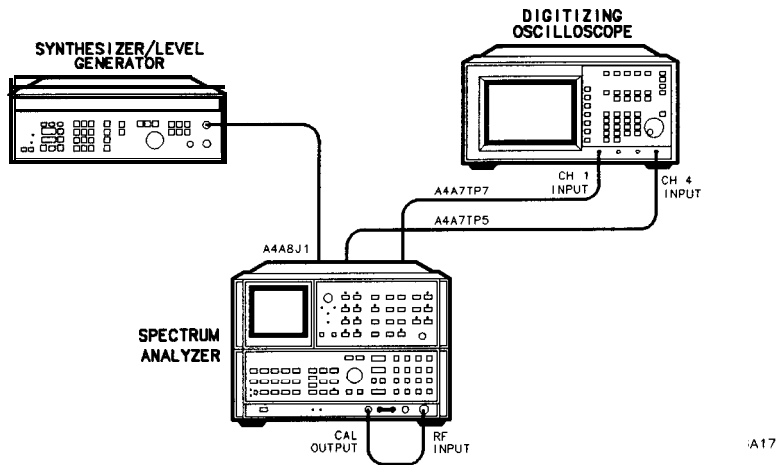

Figure 3-37. 3 MHz Bandwidth Filter Adjustments Setup

7. 3 MHz Bandwidth Filter Adjustments

Equipment	10:1 Divider Probe, 10 M Ω /7.5 pF (2 required).	HP 10432A
	Frequency Synthesizer	HP3335A
	Oscilloscope	HP 54501A
	Crystal Filter Bypass Network (4 <i>required</i>)	See Figure 3-109
	Test Cable: BNC to SMB snap-on	HP 85680-60093

- Procedure**
1. Position the spectrum analyzer upright as shown in Figure 3-37 and remove the IF-Display Section top cover.
 2. Set the spectrum analyzer LINE switch to ON and press **2-22 GHz**.

- Frequency Zero Check**
3. Connect CAL OUTPUT signal to RF INPUT
 4. Key in **RECALL 9**.
 5. Adjust front panel FREQ ZERO control for maximum signal amplitude on the CRT display.

- Filter Center and Symmetry Adjustments**
6. Key in **CENTER FREQUENCY** 100 MHz, **FREQUENCY SPAN** 10 kHz, **RES BW** 1 kHz, and press **LIN** pushbutton. Press **REFERENCE LEVEL** and adjust reference level, using step keys and front-panel knob to place signal peak near top CRT graticule line.
 7. On A4A7 3 MHz Bandwidth Filter Assembly connect crystal filter bypass networks between the two test points above C41 SYM, C32 SYM, C23 SYM, and C14 SYM. See Figure 3-38 for the location of A4A7 3MHz Bandwidth filter.
 8. Adjust A4A7C7 CTR for minimum amplitude of the displayed signal peak. Adjust A4A7C6 SYM for best symmetry of the displayed signal. Repeat adjustments to ensure that the displayed signal is **nulled** and adjusted for best symmetry. See Figure 3-38 for location of adjustments.

Note You may find it helpful to widen and narrow the spectrum analyzer frequency span to adjust the **bandpass** symmetry and centering for each filter stage.

7. 3 MHz Bandwidth Filter Adjustments

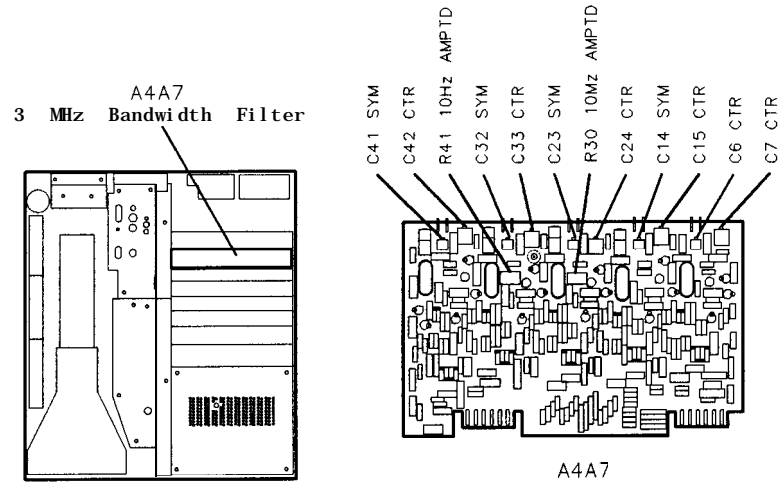

Figure 3-38.
Location of Center, Symmetry, and 10 Hz Amplitude Adjustments

9. Remove crystal filter bypass network near C14 SYM.
10. Adjust A4A7C15 CTR for minimum amplitude of the displayed signal peak. Adjust A4A7C14 SYM for best symmetry of the displayed signal. Repeat adjustments to ensure that the signal is **nulled** and adjusted for best symmetry. See Figure 3-38 for location of adjustments.
11. Remove crystal filter bypass network near C23 SYM.
12. Adjust A4A7C24 CTR for minimum amplitude of the displayed signal peak. Adjust A4A7C23 SYM for best symmetry of the displayed signal. Repeat adjustments to ensure that signal is **nulled** and adjusted for best symmetry. See Figure 3-38 for location of adjustments.
13. Remove crystal filter bypass network near C32 SYM.
14. Adjust A4A7C33 CTR for minimum amplitude of the displayed signal peak. Adjust A4A7C32 SYM for best symmetry of the displayed signal. Repeat adjustments to ensure that signal is **nulled** and adjusted for best symmetry. See Figure 3-38 for location of adjustments.
15. Remove crystal filter bypass network near C41 SYM.
16. Adjust A4A7C42 CTR for minimum amplitude of the displayed signal peak. Adjust A4A7C41 SYM for best symmetry of the displayed signal. Repeat adjustments to ensure that the signal is **nulled** and adjusted for best symmetry. See Figure 3-38 for location of adjustments.
17. Signal should be centered on center graticule line on CRT display. If signal is not centered, repeat steps 3 through 16 to readjust each filter stage.

Filter Peak Adjust

Note

The adjustment ranges of A4A7C13 PK, A4A7C22 PK, A4A7C31 PK, and A4A7C40 PK are all indirectly affected by factory-select components A4A7C93 and A4A7C5. A4A7C93 and A4A7C5 set the peak frequency for the first 3 MHz filter pole, setting the reference for peaking the amplitudes of the remaining 4 poles. In the following steps, decrease or increase the value of A4A7C93 and A4A7C5 as necessary only if adjustments A4A7C13 PK, A4A7C22 PK, A4A7C31 PK, and A4A7C40 PK are all near the same end of their adjustment range (fully meshed, maximum capacitance, or unmeshed, minimum capacitance). If the adjustable capacitors are fully meshed, decrease the value of A4A7C93.

18. Press **2-22 GHz**.
19. Key in **[SWEEP TIME] 20 ms**, **[FREQUENCY SPAN] 0 Hz**, **[RES BW] 10 Hz**, **[REFERENCE LEVEL] -20 dBm**.
20. Set the frequency synthesizer for 21.400 MHz at an amplitude level of -25.0 dBm.
21. Disconnect cable 97 (white/violet) from A4A8J1 and connect output of the frequency synthesizer to A4A8J1 using BNC to SMB snap-on cable.
22. Set the oscilloscope following Settings:

Press **[CHAN]**

Channel 1 on
probe 10:1
amplitude scale 50 mV/div
coupling ac
Channel 4 on
probe 10:1
amplitude scale 50 mV/div
coupling ac

Press **[TRIG]**

EDGE TRIGGER auto, edge
source Channel 1

Press **[TIME]**

time scale 200 ns/div
------------	------------------

Press **[DISPLAY]**

connect dots on
--------------	----------

Press **[SHOW]**

23. Connect the oscilloscope channel 1 probe to A4A7TP7 (left side of C14 SYM) and the channel 4 probe to A4A7TP5 (left side of C23 SYM).
24. Adjust the frequency synthesizer output frequency for maximum peak-to-peak signal on the oscilloscope channel 1 display.
25. Adjust A4A7C13 PK for maximum peak-to-peak signal on channel 4 display. See Figure 3-39 for location of adjustment. If unable to achieve 1 “peak” in signal amplitude, increase or decrease value of A4A7C12. Refer to Table 3-3 for range of values.

7. 3 MHz Bandwidth Filter Adjustments

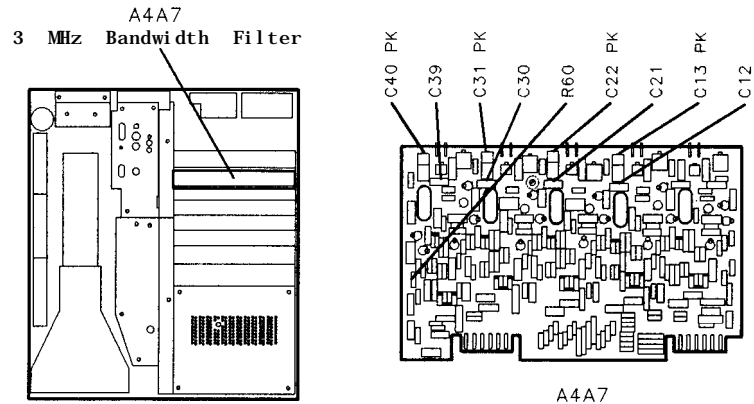

Figure 3-39. Location of 3 MHz Peak Adjustments

26. Move the oscilloscope channel 4 probe to A4A7TP3 (left side of C32 SYM).
27. Adjust frequency synthesizer output frequency to peak the oscilloscope channel 1 display.
28. Adjust A4A7C22 PK for maximum peak-to-peak signal on channel 4 display. See Figure 3-39 for location of adjustment. If unable to achieve a “peak” in signal amplitude, increase or decrease value of A4A7C21. Refer to Table 3-3 for range of values.
29. Move the oscilloscope channel 4 probe to A4A7TP1 (left side of C41 SYM).
30. Adjust frequency synthesizer output frequency to peak the oscilloscope channel 1 display.
31. Adjust A4A7C31 PK for maximum peak-to-peak signal on the oscilloscope channel 4 display. See Figure 3-39 for location of adjustment. If unable to achieve a “peak” in signal amplitude, increase or decrease value of A4A7C30. Refer to Table 3-3 for range of values.
32. Disconnect the oscilloscope channel 4 probe from A4A7TP1.
33. Adjust frequency synthesizer output frequency to peak the oscilloscope channel 1 display.
34. On the spectrum analyzer, adjust REFERENCE LEVEL using step keys to place signal near top CRT graticule line.
35. Adjust A4A7C40 PK for maximum signal amplitude on the spectrum analyzer CRT display. See Figure 3-39 for the location of adjustment. If unable to achieve a “peak” in signal amplitude, increase or decrease value of A4A7C39. Refer to Table 3-3 for range of values.
36. Disconnect the oscilloscope channel 1 probe from A4A7TP7. Disconnect frequency synthesizer output from A4A8J1 and reconnect cable 97 (white/violet) to A4A8J1.

7. 3 MHz Bandwidth Filter Adjustments

10 Hz Amplitude Adjustments

37. Connect CAL OUTPUT to RF INPUT. Key in **2-22 GHz**, **RECALL** 9, **RES BW** 10 Hz.
38. Adjust the spectrum analyzer front panel FREQ ZERO control for maximum signal amplitude on the CRT display.
39. Key in **RES BW** 1 kHz and DISPLAY LINE **ENTER**. Using the DATA knob, place the display line at the signal trace.
40. Key in **RES BW** 10 Hz.
41. Adjust the spectrum analyzer front panel FREQ ZERO control for maximum signal amplitude on the CRT display.
42. Adjust **A4A7R30** 10 Hz AMPTD and **A4A7R41** 10 Hz AMPTD equal amounts to set the signal level the same as the reference level set in step 39. See Figure 3-38 for location of 10 Hz AMPTD adjusts.
43. Repeat steps 37 through 42 until no further adjustment is required.

Note

Factory-select component **A4A7R60** sets the overall gain of the **A4A7** 3 MHz Bandwidth Filter, and is selected as required in Adjustment Procedure 10, "Step Gain and 18.4 MHz Local Oscillator Adjustments." This procedure should be performed if the **A4A7** 3 MHz Bandwidth Filter or the **A4A5** Step Gain Assembly is replaced or repaired.

Note

The remaining adjustments and selection of factory-select components for the **A4A7** 3 MHz Bandwidth Filter are performed in Adjustment Procedure 9, "3-dB Bandwidth Adjustments." This procedure should be performed if the **A4A7** 3 MHz Bandwidth Filter is replaced or repaired.

8. 21.4 MHz Bandwidth Filter Adjustments

Reference IF-Display Section
 A4A4 Bandwidth Filter
 A4A8 Attenuator-Bandwidth Filter

Related Performance Tests IF Gain Uncertainty Test
 Resolution Bandwidth Switching Uncertainty test
 Resolution Bandwidth Selectivity Test

Description First the LC Filters (100 kHz to 3 MHz bandwidths) on the A4A4 Bandwidth Filter are adjusted. The crystal filter poles (3 kHz to 30 kHz bandwidths) are then adjusted for center and symmetry by bypassing all but one pole at a time and adjusting the active pole.

Next, the LC filters and the crystal filter poles on the A4A8 Attenuator-Bandwidth Filter are adjusted in the same manner as on the A4A4 Bandwidth Filter.

Last, the 10 dB and 20 dB attenuators on the A4A8 Attenuator-Bandwidth Filter are adjusted for the proper amount of attenuation. This is done by connecting the CAL OUTPUT signal to the RF INPUT through two step attenuators, keying in the necessary reference level to activate the 10 dB and the 20 dB control lines, adjusting the step attenuators to compensate for the attenuation, and adjusting the attenuators for the proper amount of attenuation.

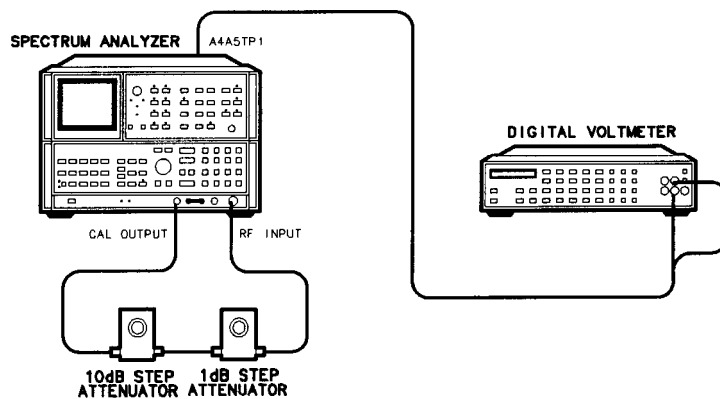

Figure 3-40. 21.4 MHz Bandwidth Filter Adjustments Setup

8. 21.4 MHz Bandwidth Filter Adjustments

Equipment

Digital Voltmeter (DVM) HP 3456A
 10 dB Step Attenuator HP 355D, Option H89
 1 dB Step Attenuator HP 3556, Option H25
 Crystal Filter Bypass Network (2 required) . . Refer to Figure 3-109

Procedure

+ 10 V Temperature Compensation Supply Check

A4A4 LC Adjustments

1. Position the spectrum analyzer upright as shown in Figure 3-40 and remove the IF-Display Section cover.
2. Set the spectrum analyzer LINE switch to ON and press **2-22 GHz**.
3. Connect DVM to A4A5TP1 (+ 10 VF).
4. DVM indication should be between +9.0 V dc and + 10.0 V dc. If voltage is not within tolerance, perform Adjustment Procedure 10, "Step Gain and 18.4 MHz Local Oscillator Adjustments," before continuing.
5. Connect spectrum analyzer CAL OUTPUT to RF INPUT through 1 dB and 10 dB step attenuators, as shown in Figure 3-40. Set step attenuators to 0 dB.
6. Disconnect cable 97 (white/violet) from A4A8J1 and connect to cable A4A6J 1.
7. Key in **CENTER FREQ** 100 MHz, **RES BW** 100 kHz, **FREQUENCY SPAN** 200 kHz, and press LIN pushbutton.
8. Press **REFERENCE LEVEL** and adjust front-panel knob to set signal peak approximately 2 divisions down from top CRT graticule line.
9. Adjust A4A4C67 LC CTR and A4A4C19 LC CTR for maximum MARKER level as indicated by CRT annotation. See Figure 3-41 for location of adjustments. If unable to adjust LC CTR adjustments for satisfactory signal amplitude, increase or decrease value of A4A4C17 and A4A4C70. Refer to Table 3-3 for range of values.

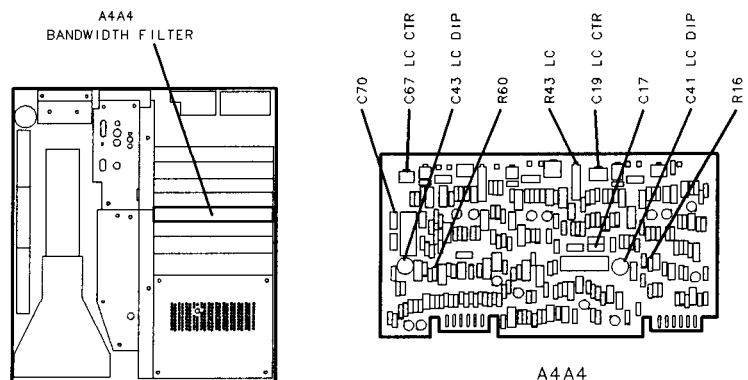

Figure 3-41.
Location of A4A4 21.4 MHz LC Filter Adjustments

10. Key in **RES BW** 1 MHz, and (SPAN) 2 MHz, MARKER **(PEAK SEARCH)**, MARKER **(Δ)**.

8. 21.4 MHz Bandwidth Filter Adjustments

11. Key in **RES BW** 100 kHz, **FREQ SPAN** 200 kHz and **MARKER** **PEAK SEARCH**.
12. Adjust **A4A4R43** LC to align markers on display. **MARKER A** level should indicate 1.00 X. See Figure 3-41 for location of adjustment.
13. Repeat steps 10 through 12 until no further adjustment is necessary.

A4A4 XTAL Adjustments

14. Key in **MARKER** **OFF**, **RES BW** 30 kHz and **FREQUENCY SPAN** 100 kHz.
15. Press **REFERENCE LEVEL** and adjust **DATA** knob to set signal peak approximately 2 divisions down from the top CRT graticule line.
16. Connect crystal filter bypass networks between **A4A4TP1** and **A4A4TP2** and between **A4A4TP4** and **A4A4TP5**.
17. Adjust **A4A4C20** CTR to center signal on center graticule line. Adjust **A4A4C9** SYM for best symmetry of signal. See Figure 3-42 for location of adjustments. If unable to adjust **SYM** for satisfactory signal symmetry, increase or decrease value of **A4A4C10**. Refer to Table 3-3 for range of values.

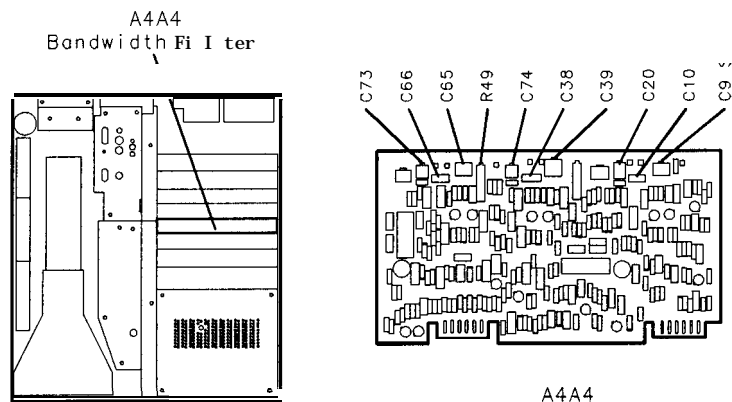

Figure 3-42.
Location of A4A4 21.4 MHz Crystal Filter Adjustments

18. Remove crystal filter bypass network from between **A4A4TP4** and **A4A4TP5**.
19. Adjust **A4A4C74** CTR to center signal on center graticule line. Adjust **A4A4C39** SYM for best symmetry of signal. See Figure 3-42 for location of adjustments. If unable to adjust **A4A4C39** SYM for satisfactory signal symmetry, increase or decrease value of **A4A4C38**. Refer to Table 3-3 for range of values.
20. Remove crystal filter bypass network from between **A4A4TP1** and **A4A4TP2**.
21. Adjust **A4A4C73** CTR to center signal on center graticule line. Adjust **A4A4C65** SYM for best symmetry of signal. See Figure 3-42 for location of adjustments. If unable to adjust **A4A4C65** SYM

8. 21.4 MHz Bandwidth Filter Adjustments

- for satisfactory signal symmetry, increase or decrease value of A4A4C66. Refer to Table 3-3 for range of values.
22. All crystal filter bypass networks are removed. Signal should be centered and symmetrical. If not, go back to step 14 and repeat adjustments.
 23. Press MARKER PEAK SEARCH and MARKER Δ.
 24. Key in FREQUENCY SPAN 20 kHz, RES BW 3 kHz, and MARKER PEAK SEARCH.
 25. Adjust A4A4R49 XTAL to align markers on display. MARKER A level should indicate 1.00 X. See Figure 3-42 for location of adjustment.

A4A8 LC Adjustments

26. Disconnect cable 97 (white/violet) from A4A6J1 and reconnect cable to A4A8J1. Reconnect cable 89 (gray/white) to A4A6J1.
27. Key in RES BW 100 kHz and FREQUENCY SPAN 200 kHz.
28. Press REFERENCE LEVEL and adjust DATA knob to place signal peak approximately two divisions down from the top graticule line.
29. Adjust A4A8C32 LC CTR and A4A8C46 LC CTR for maximum MARKER level as indicated by CRT annotation. See Figure 3-43 for location of adjustments. If unable to adjust A4A8C32 and A4A8C46 LC CTR adjustments for satisfactory signal amplitude, increase or decrease value of A4A8C35 and A4A8C49. Refer to Table 3-3 for range of values.

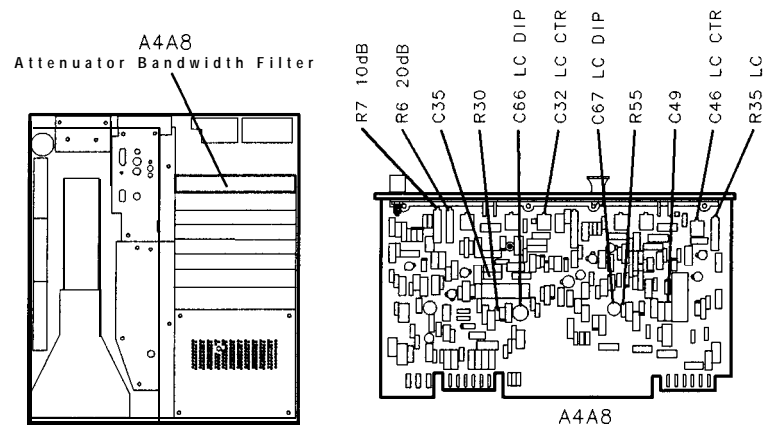

Figure 3-43.
Location of A4A8 21.4 MHz LC Filter and Attenuation Adjustments

30. Key in RES BW 1 MHz and FREQ SPAN 2 MHz, MARKER PEAK SEARCH and MARKER la.
31. Key in RES BW 100 kHz, FREQ SPAN 200 kHz, and MARKER PEAK SEARCH.

8. 21.4 MHz Bandwidth Filter Adjustments

32. Adjust A4A8R35 LC to align markers on display. MARKER A level should indicate 1.00 X. See Figure 3-43 for location of adjustment.
33. Repeat steps 30 through 32 until no further adjustment is necessary.

A4A8 XTAL Adjustments

34. Key in **[RES BW]** 30 kHz, **[FREQUENCY SPAN]** 100 kHz **MARKER [OFF]**.
35. Press **[REFERENCE LEVEL]** and adjust DATA knob to set signal peak approximately 2 divisions down from top CRT graticule line.
36. Connect crystal filter bypass network between A4A8TP1 and A4A8TP2.
37. Adjust A4A8C44 CTR to center signal on center graticule line. Adjust A4A8C42 SYM for best symmetry of signal. See Figure 3-44 for location of adjustments. If unable to adjust A4A8C42 SYM for satisfactory signal symmetry, increase or decrease value of A4A8C43. Refer to Table 3-3 for range of values.

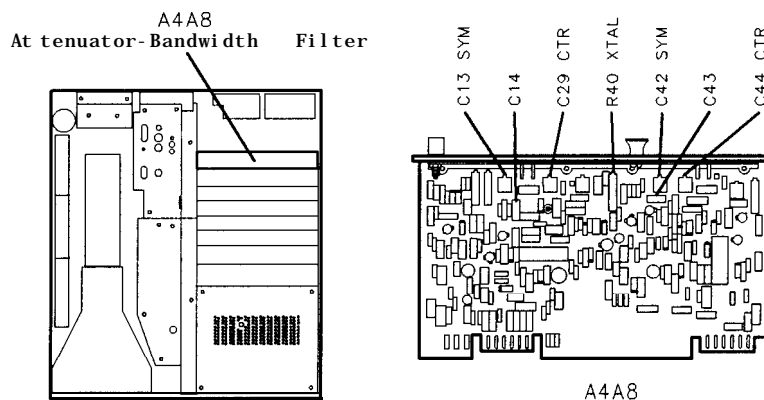

Figure 3-44.
Location of A4A8 21.4 MHz Crystal Filter Adjustments

38. Remove crystal filter bypass network from between A4A8TP1 and A4A8TP2.
39. Adjust A4A8C29 CTR to center signal on center graticule line. Adjust A4A8C13 SYM for best symmetry of signal. See Figure 3-44 for location of adjustments. If unable to adjust A4A8C13 SYM for satisfactory signal symmetry, increase or decrease value of A4A8C14. Refer to Table 3-3 for range of values.
40. Key in **[FREQUENCY SPAN]** 10 kHz, **MARKER [PEAK SEARCH]**, and **MARKER [Δ]**
41. Key in **[RES BW]** 3 kHz and **MARKER [PEAK SEARCH]**.
42. Adjust A4A8R40 XTAL to align markers on display. MARKER A level should indicate 1.00 X. See Figure 3-44 for location of adjustment.

8. 21.4 MHz Bandwidth Filter Adjustments

A10 dB and A20 dB Adjustments

43. Connect CAL OUTPUT to RF INPUT through 1 dB and 10 dB step attenuators. Set step attenuators to 25 dB.
44. Key in $\overline{\text{CENTER FREQUENCY}}$ 100 MHz, $\overline{\text{FREQUENCY SPAN}}$ 3 kHz, $\overline{\text{ATTEN}}$ 0 dB, $\overline{\text{RES BW}}$ 1 kHz, $\overline{\text{REFERENCE LEVEL}}$ -30 dBm.
45. Key in LOG $\overline{\text{CENTER dB/DIV}}$ 1 dB, MARKER [al
46. Key in $\overline{\text{REFERENCE LEVEL}}$ -20 dBm. Set step attenuators to 15 dB.
47. Adjust A4A8R7 A10dB to align markers on display. MARKER A level should indicate 0.00 dB. See Figure 3-43 for location of adjustment.
48. Key in $\overline{\text{REFERENCE LEVEL}}$ -10 dBm. Set step attenuators to 5 dB.
49. Adjust A4A8R6 A20dB to align markers on display. MARKER A level should indicate 0.00 dB. See Figure 3-43 for location of adjustment.
50. Refer to Performance Test 5, "Resolution Bandwidth Switching Uncertainty Test", and check the amplitudes of resolution bandwidths from 1 kHz through 3 MHz. If the amplitude of the 300 kHz resolution bandwidth is more than 0.3 dB low relative to the 100 kHz and 1 MHz resolution bandwidths, perform steps 51 through 71, LC Dip Adjustments.

If the amplitudes of the 3 kHz, 10 kHz, and 30 kHz resolution bandwidths are not within ± 0.4 dB of the amplitude of the 1 MHz resolution bandwidth, perform steps 1 through 12 (Bandpass Filter Adjustments) of Adjustment Procedure 5, "Log Amplifier Adjustments" and then check the amplitudes of the resolution bandwidths from 3 kHz through 3 MHz again. If the amplitudes of the 3 kHz, 10 kHz, and 30 kHz resolution bandwidths are still not within ± 0.4 dB of the 1 MHz resolution bandwidth, change the value of factory-select component A4A4R35 or A4A4R3.

An increase of one standard value of A4A4R35 decreases the amplitudes of the 100 kHz through 3 MHz resolution bandwidths by approximately 0.15 dB. An increase of one standard value of A4A4R3 decreases the amplitudes of the 3 kHz through 30 kHz resolution bandwidths by approximately 0.05 dB.

If the amplitudes of the 3 kHz through 3 MHz resolution bandwidths are not within ± 0.4 dB of the amplitude of the 1 kHz resolution bandwidth, perform Adjustment Procedure 7, "3 MHz Bandwidth Filter Adjustments," and Adjustment Procedure 11, "Down/Up Converter Adjustments."

LC Dip Adjustments

51. Set spectrum analyzer LINE switch to STANDBY.
52. Disconnect cable 97 (white/violet) from A4A8J1 and connect cable to A4A6J1.
53. Remove A4A4 Bandwidth Filter and install on 2 extender boards.
54. Set spectrum analyzer LINE switch to ON. Press $\overline{\text{2-22 GHz}}$.
55. Key in $\overline{\text{CENTER FREQUENCY}}$ 100 MHz, $\overline{\text{RES BW}}$ 100 kHz, $\overline{\text{FREQUENCY SPAN}}$ 1 MHz, $\overline{\text{ATTEN}}$ 0 dB, LOG $\overline{\text{CENTER dB/DIV}}$ 2 dB.
56. Set step attenuators to 0 dB. Short A4A4TP3 to ground.

8. 21.4 MHz Bandwidth Filter Adjustments

57. Adjust **A4A4C41** LC DIP for minimum amplitude of signal peak. See Figure 3-41 for location of adjustment. Key in **MARKER** (PEAK SEARCH), **MARKER** **(Δ)**, and then press **MARKER** (PEAK SEARCH) and re-adjust LC DIP to offset the signal peak approximately -17 kHz (to the left). This is done to compensate for operating the **A4A4** Bandwidth Filter on extender boards. If unable to achieve a “dip” in signal amplitude, increase or decrease value of **A4A4R16**. Refer to **Table 3-3** for range of values.
58. Remove short from **A4A4TP3** and short **A4A4TP8** to ground.
59. Adjust **A4A4C43** LC DIP for minimum amplitude of signal peak. See Figure 3-41 for location of adjustment. Key in **MARKER** (PEAK SEARCH), **MARKER** **(Δ)**, and then press **MARKER** (PEAK SEARCH) and re-adjust LC DIP to offset the signal peak approximately -17 kHz (to the left). If unable to achieve a “dip” in signal amplitude, increase or decrease value of **A4A4R60**. Refer to **Table 3-3** for range of values.
60. Set spectrum analyzer LINE switch to STANDBY.
61. Reinstall **A4A4** Bandwidth Filter without extender boards. Short **A4A4TP3** and **A4A4TP8** to ground. Remove **A4A8** Attenuator-Bandwidth Filter and install on extenders. Reconnect cable 97 to **A4A8J1** and reconnect cable 89 to **A4A6J1**.
62. Set spectrum analyzer LINE switch to ON. Press **(2-22 GHz)**.
63. Key in (CENTER FREQUENCY) 100 MHz, **(RES BW)** 100 kHz, (FREQUENCY SPAN) 1 MHz, **(ATTEN)** 0 dB, LOG (ENTER dB/DIV) 2 dB.
64. Short **A4A8TP6** to ground.
65. Adjust **A4A8C66** LC DIP for minimum amplitude of signal peak. See Figure 3-43 for location of adjustment. Key in **MARKER** (PEAK SEARCH), **MARKER** **(Δ)**, and then press **MARKER** (PEAK SEARCH) and re-adjust LC DIP to offset the signal peak approximately -17 kHz (to the left). If unable to achieve a “dip” in signal amplitude, increase or decrease value of **A4A8R30**. Refer to **Table 3-3** for range of values.
66. Remove short from **A4A8TP6** and short **A4A8TP3** to ground.
67. Adjust **A4A8C67** LC DIP for minimum amplitude of signal peak. See Figure 3-43 for location of adjustment. Key in **MARKER** (PEAK SEARCH), **MARKER** [a, and then press **MARKER** (PEAK SEARCH) and re-adjust LC DIP again to offset the signal peak approximately -17 kHz (to the left). If unable to achieve a “dip” in signal amplitude, increase or decrease value of **A4A8R55**. Refer to **Table 3-3** for range of values.
68. Set spectrum analyzer LINE switch to STANDBY.
69. Reinstall **A4A8** Attenuator-Bandwidth Filter without extender boards. Remove short from **A4A8TP3**.
70. Set spectrum analyzer LINE switch to ON. Press **(2-22 GHz)**.
71. Repeat LC adjustments for both the **A4A4** Bandwidth filter (steps 5 through 13) and the **A4A8** Attenuator-Bandwidth Filter (steps 26 through 33).

9. 3 dB Bandwidth Adjustments

(For instruments with Option 462, refer to Chapter 4.)

Reference IF-Display Section
A4A9 IF Control

Related Performance Test Resolution Bandwidth Accuracy Test

Description The spectrum analyzer CAL OUTPUT signal is connected to the RF INPUT. Each of the adjustable resolution bandwidths is selected and adjusted for the proper 3-dB bandwidth.

Equipment No test equipment is required for this adjustment.

- Procedure**
1. Position the spectrum analyzer upright and remove the IF-Display Section top cover.
 2. Set the spectrum analyzer LINE switch to ON and press **(2-22 GHz)**.
 3. Connect the spectrum analyzer CAL OUTPUT to the RF INPUT.
 4. On the spectrum analyzer, key in the following settings:

(CENTER FREQUENCY) 100 MHz
(FREQUENCY SPAN) 3 MHz
(RES BW) 3 MHz
SCALE LIN

5. On the spectrum analyzer, key in (SHIFT) RES BW A [AUTO], **(REFERENCE LEVEL)** and use the DATA knob to position the signal peak near the reference level (top graticule line).
6. On the spectrum analyzer, key in **(PEAK SEARCH)**, **MARKER (Δ)**, and press **(↓)** several times to position the second marker at the leftmost graticule line.
7. Adjust A4A9R60 3 MHz for a MARKER A indication of -3.00 dB ±0.05 dB. See Figure 3-45 for location of adjustment.
8. On the spectrum analyzer, press **(↑)** several times to position the second marker at the rightmost graticule line. Then, press **(STOP FREQ)** and use the DATA knob to adjust the centering of the displayed signal for a MARKER A indication of -3.00 dB ±0.05 dB.

9. 3 dB Bandwidth Adjustments

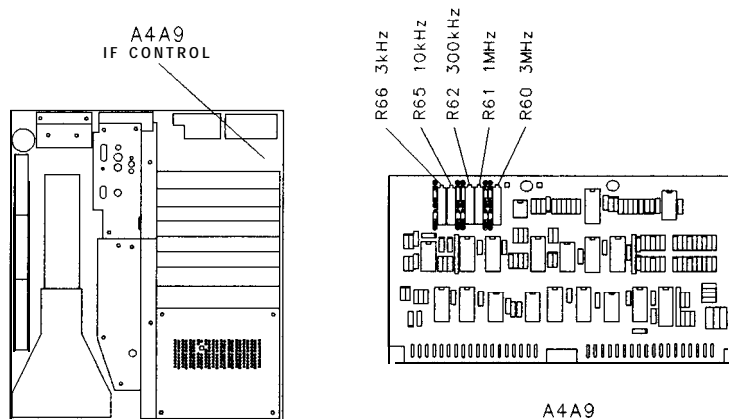

Figure 3-45. Location of 3 dB Bandwidth Adjustments

9. On the spectrum analyzer, key in $\overline{[FREQUENCY SPAN]} 3 \text{ MHz}$, $\overline{[MARKER (OFF)]}$, $\overline{[PEAK SEARCH]}$, $\overline{[MARKER (\Delta)]}$, and press $\overline{[\downarrow]}$ several times to position the second marker at the leftmost graticule line.
10. Readjust A4A9R60 3 MHz for a MARKER A indication of $-3.00 \text{ dB} \pm 0.05 \text{ dB}$.
11. Repeat steps 8 through 10 as necessary until no further adjustment is required.
12. On the spectrum analyzer, key in the following settings:

$\overline{[CENTER \text{ FREQUENCY}]}$	100 MHz
$\overline{[FREQUENCY SPAN]}$1 MHz
$\overline{[RES BW]}$	1 MHz
13. On the spectrum analyzer, press $\overline{[REFERENCE LEVEL]}$ and use the DATA knob to position the signal peak near the reference level (top graticule line).
14. On the spectrum analyzer, key in $\overline{[PEAK SEARCH]}$, $\overline{[MARKER (\Delta)]}$, and press $\overline{[\downarrow]}$ several times to position the second marker at the leftmost graticule line.
15. Adjust A4A9R61 1 MHz for a MARKER A indication of $-3.00 \text{ dB} \pm 0.05 \text{ dB}$.
16. On the spectrum analyzer, press $\overline{[\uparrow]}$ several times to position the second marker at the rightmost graticule line. Then, press $\overline{[STOP FREQ]}$ and use the DATA knob to adjust the centering of the displayed signal for a MARKER A indication of $-3.00 \text{ dB} \pm 0.05 \text{ dB}$.
17. On the spectrum analyzer, key in $\overline{[FREQUENCY SPAN]} 1 \text{ MHz}$, $\overline{[MARKER (OFF)]}$, $\overline{[PEAK SEARCH]}$, $\overline{[MARKER (Ia)]}$, and press $\overline{[\downarrow]}$ several times to position the second marker at the leftmost graticule line.
18. Readjust A4A9R61 1 MHz for a MARKER A indication of $-3.00 \text{ dB} \pm 0.05 \text{ dB}$.
19. Repeat steps 16 through 18 as necessary until no further adjustment is required.

9. 3 dB Bandwidth Adjustments

20. On the spectrum analyzer, key in the following settings:

<u>CENTER FREQUENCY</u>	100 MHz
<u>FREQUENCY SPAN</u>	300 kHz
<u>RES BW</u>	300 kHz

21. On the spectrum analyzer, press REFERENCE LEVEL and use the DATA knob to position the signal peak near the reference level (top graticule line).
22. On the spectrum analyzer, key in PEAK SEARCH, MARKER (Δ), and press (⇓) several times to position the second marker at the leftmost graticule line.
23. Adjust A4A9R62 300 kHz for a MARKER A indication of -3.00 dB f0.05 dB.
24. On the spectrum analyzer, press (⇑) several times to position the second marker at the rightmost graticule line. Then, press STOP FREQ and use the DATA knob to adjust the centering of the displayed signal for a MARKER A indication of -3.00 dB f0.05 dB.
25. On the spectrum analyzer, key in FREQUENCY SPAN 300 kHz, MARKER (OFF), PEAK SEARCH, MARKER (Δ), and press (⇓) several times to position the second marker at the leftmost graticule line.
26. Readjust A4A9R62 300 kHz for a MARKER A indication of -3.00 dB f0.05 dB.
27. Repeat steps 24 through 26 as necessary until no further adjustment is required.

Note

The 100 kHz 3-dB bandwidth is set with factory-select components A4A8R30, A4A8R55, A4A4R16, and A4A4R60. If it is necessary to increase the 100 kHz 3-dB bandwidth, increase the value of one or more of these factory-select components. The 30 kHz 3-dB bandwidth is set with factory-select components A4A8R26, A4A8R52, A4A4R20, A4A4R40, and A4A4R64. If it is necessary to increase the 30 kHz 3-dB bandwidth, decrease the value of one or more of these factory-select components. Refer to Table 3-3 for the acceptable range of values for A4A8R30, A4A8R55, A4A4R16, A4A4R60, A4A8R26, A4A8R52, A4A4R20, A4A4R40, and A4A4R64, and to Table 3-4 for HP part numbers.

28. On the spectrum analyzer, key in the following settings:

<u>CENTER FREQUENCY</u>	100 MHz
<u>FREQUENCY SPAN</u>	10 kHz
<u>RES BW</u>	10 kHz

29. On the spectrum analyzer, press REFERENCE LEVEL and use the DATA knob to position the signal peak near the reference level (top graticule line).
30. On the spectrum analyzer, key in PEAK SEARCH, MARKER (Δ), and press (⇓) several times to position the second marker at the leftmost graticule line.

9. 3 dB Bandwidth Adjustments

31. Adjust A4A9R65 10 kHz for a MARKER A indication of -3.00 dB \pm 0.05 dB.
32. On the spectrum analyzer, press \uparrow several times to position the second marker at the rightmost graticule line. Then, press **(STOP FREQ)** and use the DATA knob to adjust the centering of the displayed signal for a MARKER A indication of -3.00 dB f0.05 dB.
33. On the spectrum analyzer, key in **(FREQUENCY SPAN)** 10 kHz, MARKER **(OFF)**, **(PEAK SEARCH)**, MARKER **(Δ)**, and press \downarrow several times to position the second marker at the leftmost graticule line.
34. Readjust A4A9R65 10 kHz for a MARKER **(Δ)** indication of -3.00 dB f0.05 dB.
35. Repeat steps 32 through 34 as necessary until no further adjustment is required.
36. On the spectrum analyzer, key in the following settings:

(CENTER FREQUENCY)	100 MHz
(FREQUENCY SPAN)	3 kHz
(RES BW)3 kHz
37. On the spectrum analyzer, press **(REFERENCE LEVEL)** and use the DATA knob to position the signal peak near the reference level (top graticule line).
38. On the spectrum analyzer, key in **(PEAK SEARCH)**, MARKER **(Δ)**, and press \downarrow several times to position the second marker at the leftmost graticule line.
39. Adjust A4A9R66 3 kHz for a MARKER A indication of -3.00 dB \pm 0.05 dB.
40. On the spectrum analyzer, press \uparrow several times to position the second marker at the rightmost graticule line. Then, press **(STOP FREQ)** and use the DATA knob to adjust the centering of the displayed signal for a MARKER A indication of -3.00 dB f0.05 dB.
41. On the spectrum analyzer, key in **(FREQUENCY SPAN)** 3 kHz, MARKER **(OFF)**, **(PEAK SEARCH)**, MARKER **(Δ)**, and press \downarrow several times to position the second marker at the leftmost graticule line.
42. Readjust A4A9R66 3 kHz for a MARKER A indication of -3.00 dB f0.05 dB.
43. Repeat steps 40 through 42 as necessary until no further adjustment is required.

Note

The 1 kHz 3-dB bandwidth is set with factory-select components A4A7R12/A4A7R13, A4A7R23/A4A7R24, A4A7R34/A4A7R35, A4A7R45/A4A7R46, and A4A7R56/A4A7R57. If it is necessary to increase the 1 kHz 3-dB bandwidth, increase the value of one or more pairs of these factory-select components. The 300 Hz, 100 Hz, 30 Hz, and 10 Hz 3-dB bandwidths are set with factory-select components A4A7R66, A4A7R68, A4A7R70, A4A7R72, A4A7R74, A4A7R76, A4A7R78, A4A7R80, A4A7R82, A4A7R84, A4A7R86, A4A7R88, A4A7R90, A4A7R92, A4A7R94, A4A7R96, A4A7R98,

9. 3 dB Bandwidth Adjustments

A4A7R100, A4A7R102, and A4A7R104. If it is necessary to increase one of these 3-dB bandwidths, increase the value of one or more of these factory-select components. Refer to Table 3-3 for the acceptable range of values for A4A7R12/A4A7R13, A4A7R23/A4A7R24, A4A7R34/A4A7R35, A4A7R45/A4A7R46, A4A7R56/A4A7R57, A4A7R66, A4A7R68, A4A7R70, A4A7R72, A4A7R74, A4A7R76, A4A7R78, A4A7R80, A4A7R82, A4A7R84, A4A7R86, A4A7R88, A4A7R90, A4A7R92, A4A7R94, A4A7R96, A4A7R98, A4A7R100, A4A7R102, and A4A7R104, and to Table 3-4 for HP part numbers.

10. Step Gain and 18.4 MHz Local Oscillator Adjustments

Reference

IF-Display Section
A4A7 3 MHz Bandwidth Filter
A4A5 Step Gain

Related Performance Tests

Resolution Bandwidth Selectivity Test
IF Gain Uncertainty Test
Center Frequency Readout Accuracy Test

Description

First, the IF signal from the RF Section is measured with a power meter and adjusted for proper level. Next, the 10 dB gain steps are adjusted by connecting the CAL OUTPUT signal through two step attenuators to the RF INPUT and keying in the REFERENCE LEVEL necessary to activate each of the gain steps, while compensating for the increased gain with the step attenuators. The 1 dB gain steps are checked in the same fashion as the 10 dB gain steps, and then the variable gain is adjusted. The 18.4 MHz oscillator frequency is adjusted to provide adequate adjustment range of front-panel FREQ ZERO control; and last, the +10V temperature compensation supply used by the A4A4 Bandwidth Filter and A4A8 Attenuator-Bandwidth Filter is checked and adjusted if necessary.

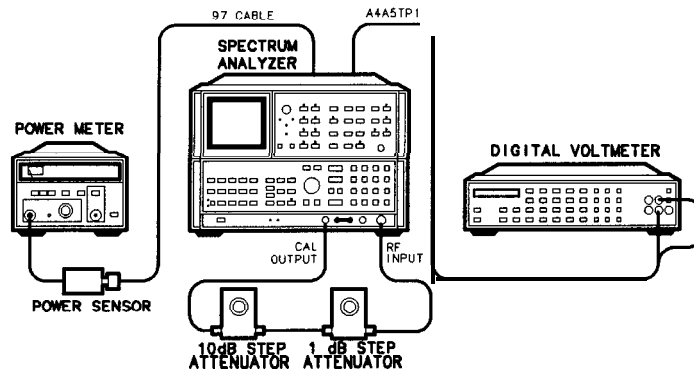

Figure 3-46.
Step Gain and 18.4 MHz Local Oscillator Adjustments Setup

10. Step Gain and 18.4 MHz Local Oscillator Adjustments

Equipment

Digital Voltmeter (DVM)	HP 3456A
Power Meter	HP 436A
Power Sensor	HP 8481A
10 dB Step Attenuator	HP 355D, Option H89
1 dB Step Attenuator	HP 355C, Option H25

Procedure

Note

Adjustment A4A5R33 CAL sets the gain of the A4A5 Step Gain Assembly with no gain steps enabled. Perform Adjustment Procedure 5, "Log Amplifier Adjustments," (steps 1-12) Adjustment Procedure 6, "Video Processor Adjustments," Adjustment Procedure 8, "2 1.4 MHz Bandwidth Filter Adjustments," and Adjustment Procedure 23, "Track and Hold Adjustments" to ensure that the signal level at the top CRT graticule line is properly set before adjusting A4A5R33 CAL.

+ 10 V Temperature Compensation Supply Adjustment

1. Position the spectrum analyzer upright as shown in Figure 3-46 and remove the IF-Display Section top cover.
2. Set the spectrum analyzer LINE switch to ON and press **2-22 GHz**.
3. Connect the spectrum analyzer CAL OUTPUT to the RF INPUT.
4. On the spectrum analyzer, key in **RECALL** 8 and adjust the front panel AMPTD CAL control for a displayed signal level of -10.00 dBm.
5. On the spectrum analyzer, key in **RECALL** 9 and adjust the front panel FREQ ZERO control for maximum amplitude of the displayed signal trace.
6. Connect DVM to A4A5TP1 (+ 10VF).
7. If DVM indication is between +9 V dc and 10.0 V dc, no adjustment is required.
8. If DVM indication is not within tolerance of step 5, adjust A4A5R2 + 10V ADJ for DVM indication of +9.5 f0.1 V dc at normal room temperature of approximately 25°C. Voltage change is approximately 30 mV/°C. Therefore, if room temperature is higher or lower than 25°C, adjustment should be made higher or lower, accordingly.

IF Gain Adjustment

9. Key in **CENTER FREQUENCY** 100 MHz, **REFERENCE LEVEL** -10 dBm, **ATTEN** 0 dB, **FREQUENCY SPAN** 0 Hz, **RES BW** 1 kHz, **VIDEO BW** 100 Hz, and **SWEEP TIME** 20 ms.
10. Disconnect cable 97 (white/violet) from A4A8J1 and connect cable to the calibrated power meter/power sensor. Refer to Figure 3-47 for location of cable 97 and A4A8J1.
11. Adjust front-panel AMPTD CAL adjustment for a power meter indication of -5 dBm.
12. Disconnect power meter and reconnect cable 97 to A4A8J1.
13. Press LIN pushbutton and MARKER **NORMAL**.

10. Step Gain and 18.4 MHz Local Oscillator Adjustments

- Note MARKER amplitude in mV and adjust A4A5R33 CAL to 70.7 mV (top CRT graticule line). See Figure 3-47 for location of adjustment.

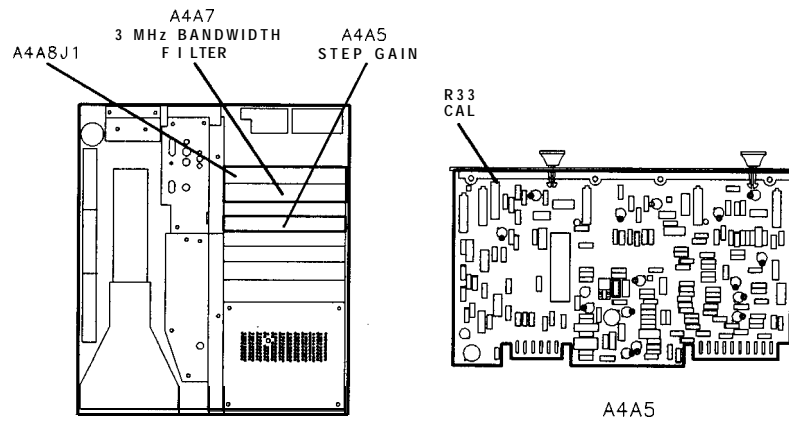

Figure 3-47. Location of IF Gain Adjustment

- If A4A5R33 CAL adjustment does not have sufficient range to adjust trace to the top CRT graticule line, increase or decrease the value of A4A7R60 as necessary to achieve the proper adjustment range of A4A5 CAL adjustment. See Figure 3-39 for the location of A4A7R60. Refer to Table 3-3 for range of values for A4A7R60.

10 dB Gain Step Adjustment

- Connect CAL OUTPUT to RF INPUT through 10 dB step attenuator and 1 dB step attenuator.
- Key in LOG CENTER dB/DIV 1 dB, VIDEO BW 3 Hz, and REFERENCE LEVEL -30 dBm.
- Set step attenuators to 25 dB.
- Key in MARKER A. Signal trace should be at the center CRT graticule line, and MKR A level, as indicated by CRT annotation, should be .00 dB.
- Key in REFERENCE LEVEL -40 dBm. Set step attenuators to 35 dB.
- Adjust A4A5R32SG10 for MKR A level of .00 dB (CRT MKR A annotation is now in upper right corner of CRT display). See Figure 3-48 for location of adjustment.

10. Step Gain and 18.4 MHz Local Oscillator Adjustments

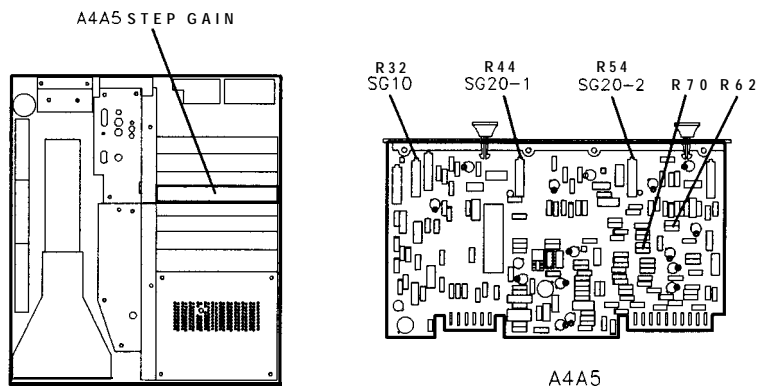

Figure 3-48. Location of 10 dB Gain Step Adjustments

22. If A4A5R32 SG10 adjustment does not have sufficient range to perform adjustment in step 19, increase or decrease the value of A4A7R60 as necessary to achieve the proper adjustment range of A4A5 SG10. See Figure 3-39 for the location of A4A7R60. Refer to Table 3-3 for range of values for A4A7R60. Repeat steps 9 through 21 if the value of A4A7R60 is changed.
23. Key in REFERENCE LEVEL -50 dBm. Set step attenuators to 45 dB.
24. Adjust A4A5R44 SG20-1 for MKR A level of .00 dB. See Figure 3-48 for location of adjustment.
25. Key in REFERENCE LEVEL -70 dBm. Set step attenuators to 65 dB.
26. Adjust A4A5R54 SG20-2 for MKR A level of .00 dB. See Figure 3-48 for location of adjustment.

1 dB Gain Step Checks

27. Key in REFERENCE LEVEL -19.9 dBm. Set step attenuators to 15 dB. Press MARKER (Δ) twice to establish a new reference.
28. Key in REFERENCE LEVEL -17.9 dBm. Set step attenuators to 13 dB.
29. MKR A level, as indicated by CRT annotation, should be .00 \pm 0.05 dB. If not, increase or decrease the value of A4A5R86. Refer to Table 3-3 for range of values.
30. Key in REFERENCE LEVEL -15.9 dBm. Set step attenuators to 11 dB.
31. MKR A level should be .00 \pm 0.05 dB. If not, increase or decrease the value of A4A5R70. Refer to Table 3-3 for range of values.
32. Key in REFERENCE LEVEL -11.9 dBm. Set step attenuators to 7 dB.
33. MKR A level should be .00 \pm 0.05 dB. If not, increase or decrease the value of A4A5R62. Refer to Table 3-3 for range of values.

10. Step Gain and 18.4 MHz Local Oscillator Adjustments

0.1 dB Gain Step Adjustment

34. Key in LIN, **(SHIFT)** ^A [AUTO] (resolution bandwidth), and **(REFERENCE LEVEL)** -19.9 dBm. Set step attenuators to 13 dB. Press **(MARKER)** **(Δ)** twice to establish a new reference.
35. Key in **(REFERENCE LEVEL)** -18.0 dBm. Set step attenuators to 11 dB.
36. Adjust A4A5R51 VR for MKR A level of +0.10 dB. See Figure 3-49 for location of adjustment.
37. Remove all test equipment from the spectrum analyzer. Connect CAL OUTPUT to RF INPUT.

18.4 MHz Local Oscillator Adjustment

38. Press **(2-22 GHz)** and **(RECALL)** **(9)**.
39. Set front-panel FREQ ZERO control to midrange.
40. Adjust A4A5C10 FREQ ZERO to peak signal trace on CRT. See Figure 3-49 for location of adjustment.

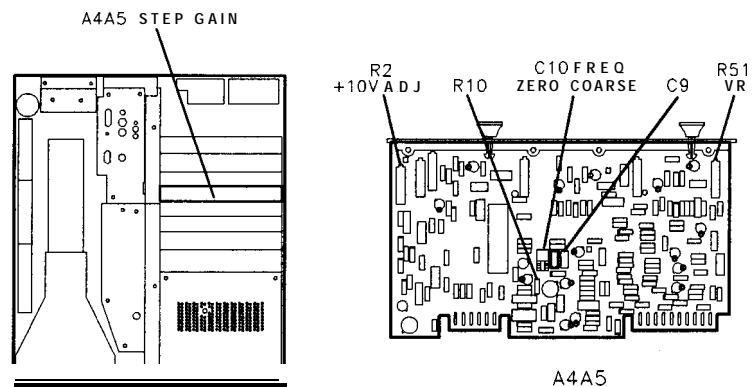

Figure 3-49.
Location of .1 dB Gain Step, 18.4 MHz LO, and +10V Adjustments

41. Key in **(FREQUENCY SPAN)** 1 kHz, **(RES BW)** 100 Hz, and **(PEAK SEARCH)** [a].
42. Adjust front-panel FREQ ZERO control fully clockwise. Press **(PEAK SEARCH)**. Signal should move at least 60 Hz away from center CRT graticule line.
43. Adjust front-panel FREQ ZERO control fully counterclockwise. Press **(PEAK SEARCH)**. Signal should move at least 60 Hz away from center CRT graticule line.
44. If proper indications are not achieved, increase or decrease value of A4A5C9 and repeat adjustment from step 33. Refer to Table 3-3 for range of values.
45. Press **(2-22 GHz)** and **(RECALL)** **(9)**.
46. Adjust front panel FREQ ZERO for maximum amplitude of the displayed signal trace.

10. Step Gain and 18.4 MHz Local Oscillator Adjustments

Note

Factory-select component **A4A7R60** affects the adjustment of **A4A6A1R29** WIDE GAIN. If the value of **A4A7R60** is changed, perform Adjustment Procedure 11, “Down/Up Converter Adjustments”.

11. Down/Up Converter Adjustments

Reference IF-Display Section
A4A6 Down/Up Converter

Related Performance Test Resolution Bandwidth Switching Uncertainty Test

Description The CAL OUTPUT signal is connected to the RF INPUT connector of the spectrum analyzer and controls are set to display the signal in a narrow bandwidth. A marker is placed at the peak of the signal to measure the peak amplitude. The bandwidth is changed to a wide bandwidth and the Down/Up Converter is adjusted to place the peak amplitude of the signal the same as the level of the narrow bandwidth signal. Optionally, the input signal is removed and the IF signal is monitored at the output of the Bandwidth Filters using a spectrum analyzer with an active probe. The 18.4 MHz Local Oscillator and all harmonics are then adjusted for minimum amplitude.

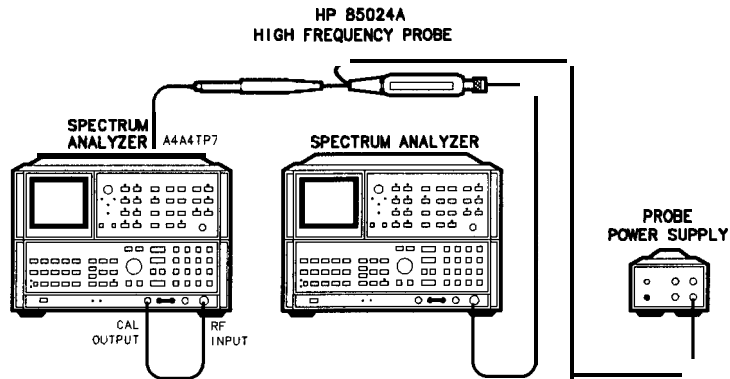

Figure 3-50. Down/Up Converter Adjustments Setup

Equipment Spectrum Analyzer HP 8566B
Active Probe HP 85024A
Probe Power Supply HP 1122A

Procedure

Note Adjustment A4A6A1R29 WIDE GAIN adjusts the amplitude of the 21.4 MHz Bandwidth Filters (3 kHz through 3 MHz) relative to the amplitude of the 3 MHz Bandwidth Filters (1 kHz through 10 Hz). Perform Adjustment Procedure 6, “Log Amplifier Adjustments,” (steps 1-12) Adjustment Procedure 8, “21.4 MHz Bandwidth Filter Adjustments,” and Adjustment Procedure 7, “3 MHz Bandwidth Filter Adjustments” to ensure that the amplitudes of the bandwidth filters are optimized before adjusting A4A6A1R29 WIDE GAIN (steps 14-17).

11. Down/Up Converter Adjustments

Note

The adjustment of A4A6A1R29 WIDE GAIN is affected by factory-select component A4A7R60, which sets the overall gain of the A4A7 3 MHz Bandwidth Filter Assembly. If the A4A7 3 MHz Bandwidth Filter Assembly or the A4A5 Step Gain Assembly is repaired or replaced, perform Adjustment Procedure 10, “Step Gain and 18.4 MHz Local Oscillator Adjustments” to select (if necessary) A4A7R60 before adjusting A4A6A1R29 WIDE GAIN (steps 14-17).

1. Position the spectrum analyzer upright as shown in Figure 3-50 and remove the IF-Display Section top cover.
2. Set the spectrum analyzer LINE switch to ON and press **2-22 GHz**.
3. Connect the spectrum analyzer CAL OUTPUT to the RF INPUT.
4. On the spectrum analyzer, key in **[RECALL-] 8** and adjust the front-panel AMPTD CAL control for a displayed signal level of -10.00 dBm.
5. On the spectrum analyzer, key in **RECALL 9** and adjust the front-panel FREQ ZERO control for maximum amplitude of the displayed signal.

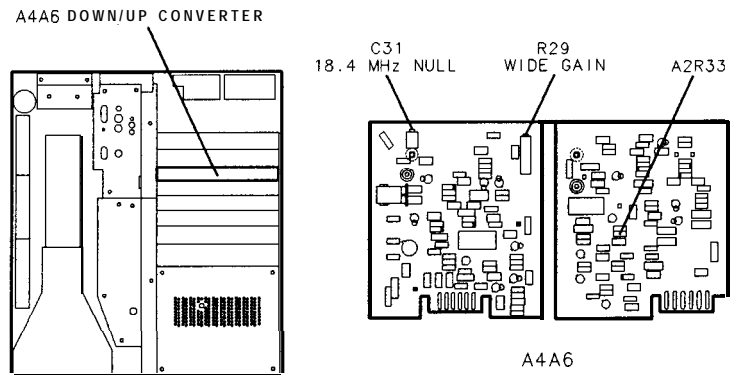

Figure 3-51. Location of Down/Up Converter Adjustments

Down Converter Gain Adjustment

Note

Perform steps 6 through 15 if the A4A6 Down/Up Converter Assembly has been repaired, or if factory-select component A4A7R60 has insufficient adjustment range. Otherwise, skip to step 17.

6. Set the spectrum analyzer LINE switch to STANDBY. Remove A4A6 Down/Up Converter Assembly from the IF-Display Section and install on two extender boards.
7. Set the spectrum analyzer LINE switch to ON, and key in **2-22 GHz**, **CENTER FREQUENCY 100 MHz**, **FREQUENCY SPAN 0 HZ**, **RES BW 1 kHz**, **REFERENCE LEVEL -10 dBm**.
8. Connect the active probe to the probe power supply and the RF INPUT of the second spectrum analyzer, as shown in Figure 3-50. On the second spectrum analyzer, key in **2-22 GHz**,

11. Down/Up Converter Adjustments

CENTER FREQUENCY 21.4 MHz, **FREQUENCY SPAN** 50 kHz, **RES BW** 10 kHz, **REFERENCE LEVEL** -30 dBm.

9. Connect the tip of the active probe to A4A6A2TP4. On the second spectrum analyzer, press **REFERENCE LEVEL** and use the DATA knob to position the peak of the displayed 21.4 MHz signal near the top CRT graticule line.
10. On the second spectrum analyzer, key in **LOG dB/DIV** 2 dB, **MARKER** **PEAK SEARCH** and record the level of the displayed 21.4 MHz signal:

Signal level at A4A6A2TP4: _____dBm

11. On the second spectrum analyzer, key in **MARKER** [al, **CENTER FREQUENCY** 3 MHz.
12. Connect the tip of the active probe to A4A6A2P1-9. On the second spectrum analyzer, key in **MARKER** **PEAK SEARCH** and record the level of the displayed 3 MHz signal:
Signal level at A4A6A2P1-9: _____dB
13. The 3 MHz signal level at A4A6A2P1-9 measured in step 12 should be 10.0 dB \pm 0.6 dB lower than the 21.4 MHz signal level at A4A6A2TP4 measured in step 10. If not, change the value of factory-select resistor A4A6A2R33. A 10% decrease in the value of A4A6A2R33 increases the signal level at A4A6A2P1-9 by approximately 0.6 dB. Refer to Table 3-3 for the acceptable range of values for A4A6A2R33 and to Table 3-4 for HP part numbers.
14. Set the spectrum analyzer LINE switch to STANDBY.
15. Remove A4A6 Down/Up Converter Assembly from the two extender boards and reinstall in the IF-Display Section.

21.4 MHz Gain

16. Set the spectrum analyzer LINE switch to ON and press **2-22 GHz**.
17. On the spectrum analyzer, key in **CENTER FREQUENCY** 100 MHz, **FREQUENCY SPAN** 10 kHz, **RES BW** 1 kHz, **REFERENCE LEVEL** -7 dBm, and press the LIN pushbutton.
18. On the spectrum analyzer, key in **MARKER** **PEAK SEARCH**, **MARKER** **Δ**, **RES BW** 1 MHz.
19. Adjust A4A6A1R29 WIDE GAIN for a MKR A indication of 1.00 X, aligning the two markers on the CRT display. See Figure 3-51 for the adjustment location.

18.4 MHz Null Adjustment

20. Disconnect the spectrum analyzer CAL OUTPUT from the RF INPUT.
21. On the spectrum analyzer, key in **REFERENCE LEVEL** -70 dBm, **RES BW** 1 kHz, **MARKER** (OFF).
22. On the second spectrum analyzer, key in **2-22 GHz**, **START FREQ** 5 MHz, **STOP FREQ** 50 MHz, **RES BW** 100 kHz.

11. Down/Up Converter Adjustments

23. Connect the tip of the active probe to **A4A4TP7**, and adjust **A4A6A1C31** 18.4 MHz NULL for minimum amplitudes of the displayed 18.4 MHz and 36.8 MHz signals on the second spectrum analyzer. The level of the displayed 18.4 MHz signal should be below -10 dBm.

If **A4A6A1C31** has insufficient adjustment range, increase the value of factory-select resistor **A4A5R10**. See Figure 3-49 for the location of **A4A5R10**. Refer to Table 3-3 for the acceptable range of values for **A4A5R10** and to Table 3-4 for HP part numbers.

12. 10 MHz Standard Adjustment (SN 2637A and Below)

Reference

RF-Section:
A22 10 MHz Frequency Standard
A22A2 Frequency Standard Regulator

Description

The frequency of the internal 10 MHz Frequency Standard is compared to a known frequency standard and adjusted for minimum frequency error. This procedure does not adjust the short-term stability or long-term stability of the 10 MHz Quartz Crystal Oscillator, which are determined by characteristics of the particular oscillator and the environmental and warmup conditions to which it has been recently exposed. The spectrum analyzer must be ON continuously (not in STANDBY) for at least 72 hours immediately prior to oscillator adjustment to allow both the temperature and frequency of the oscillator to stabilize.

Equipment

Frequency Standard
(10 MHz with aging rate of $<\pm 1 \times 10^{-10}$) HP 5061B
Frequency Counter HP 5334A/B

Cables:

BNC cable, 122 cm (48 in) (*2 required*) HP 10503A

Procedure

Note

The spectrum analyzer must be ON continuously (not in STANDBY) for at least 72 hours immediately prior to oscillator adjustment to allow both the temperature and frequency of the 10 MHz Quartz Crystal Oscillator to stabilize. Adjustment should not be attempted before the oscillator is allowed to reach its specified aging rate. Failure to allow sufficient stabilization time could result in oscillator misadjustment.

The A22A1 10 MHz Quartz Crystal Oscillator (HP P/N 0960-0477) will typically reach its specified aging rate again within 72 hours after being switched off for a period of up to 24 hours. If extreme environmental conditions were encountered during storage or shipment (i.e. mechanical shock, temperature extremes) the oscillator could require up to 30 days to achieve its specified aging rate.

1. Set the rear-panel **FREQ REFERENCE** switch on the spectrum analyzer RF Section to **INT**.
-

Note

The +22 Vdc STANDBY supply provides power to the heater circuit in the A22 10 MHz Frequency Standard assembly whenever line power is applied to the RF Section. This allows the A22 10 MHz Frequency Standard oven to remain at thermal equilibrium, minimizing frequency drift due to temperature variations. The **OVEN COLD**

12. 10 MHz Standard Adjustment (SN 2637A and Below)

message should typically appear on the spectrum analyzer display for 10 minutes or less after line power is first applied to the RF Section.

Note

The rear-panel **FREQ REFERENCE** switch enables or disables the RF Section +20 Vdc switched supply, which powers the oscillator circuits in the A22 10 MHz Frequency Standard. This switch must be set to **INT** and the spectrum analyzer must be switched **ON** continuously (not in **STANDBY**) for at least 72 hours before adjusting the frequency of the A22 10 MHz Frequency Standard.

- Set the **LINE** switch to **ON**. Leave the spectrum analyzer **ON** (not in **STANDBY**) and undisturbed for at least 48 hours to allow the temperature and frequency of the A22 10 MHz Frequency Standard to stabilize.

Note

To prolong CRT life, press **(SHIFT) (CLEAR-WRITE)** to turn off the CRT display while the spectrum analyzer is unattended, and **(SHIFT) (MAX HOLD)** to turn the CRT back on.

- Connect the (Cesium Beam) Frequency Standard to the Frequency Counter rear-panel **TIMEBASE IN/OUT** connector as shown in Figure 3-52.

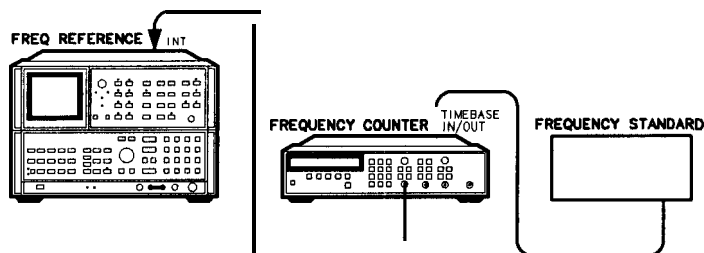

Figure 3-52. 10 MHz Frequency Standard Adjustments Setup

- Disconnect the short jumper cable on the RF Section rear panel from the **FREQ REFERENCE INT** connector. Connect this output (**FREQ REFERENCE INT**) to **INPUT A** on the Frequency Counter. A **REF UNLOCK** message should appear on the CRT display.

- Set the Frequency Counter controls as follows:

FUNCTION/DATA	FREQ A
INPUT A:		
x10 ATTN	OFF
AC	OFF (DC coupled)
50Ω Z	OFF (1 MΩ input impedance)
AUTO TRIG	ON
100 kHz FILTER A	OFF
INT/EXT switch (rear panel)	EXT

- On the Frequency Counter, select a 10 second gate time by pressing **(GATE/TIME) 10 (GATE)** displayed frequency by -10.0 MHz by pressing **MATH (SELECT/ENTER) (CHS/EEX) 10 (CHS/EEX) 6 @ELECT/ENTER (SELECT/ENTER)**. The

12. 10 MHz Standard Adjustment (SN 2637A and Below)

Frequency Counter should now display the difference between the frequency of the INPUT A signal (A22 10 MHz Frequency Standard) and 10.0 MHz with a displayed resolution of 1 mHz (0.001 Hz).

7. Wait at least two gate periods for the Frequency Counter to settle, and record the frequency of the A22 10 MHz Frequency Standard as reading #1 .

Reading # 1: _____ mHz

8. Allow the spectrum analyzer to remain powered (not in STANDBY) and undisturbed for an additional 24 hours.
9. Repeat steps 3 through 7 and record the frequency of the A22 10 MHz Frequency Standard as reading #2.

Reading #2: _____ mHz

10. If the difference between reading #2 and reading #1 is greater than 1 mHz, the A22 10 MHz Frequency Standard has not achieved its specified aging rate; the spectrum analyzer should remain powered (not in STANDBY) and undisturbed for an additional 24-hour interval. Then, repeat steps 3 through 7, recording the frequency of the 10 MHz Frequency Standard at the end of each 24-hour interval, until the specified aging rate of 1 mHz/day (1×10^{-9} /day) is achieved.

Reading #3: _____ mHz

Reading #4: _____ mHz

Reading #5: _____ mHz

Reading #6: _____ mHz

Reading #7: _____ mHz

Reading #8: _____ mHz

Reading #9: _____ mHz

Reading #10: _____ mHz

Reading # 11: _____ mHz

11. Position the spectrum analyzer on its right side as shown in Figure 3-52, and remove the bottom cover. Typically, the frequency of the A22 10 MHz Frequency Standard will shift slightly when the spectrum analyzer is reoriented. Record this shifted frequency of the A22 10 MHz Frequency Standard.

Reading # 11: _____ mHz

12. Subtract the shifted frequency reading in step 11 from the last recorded frequency in step 10. This gives the frequency correction factor needed to adjust the A22 10 MHz Frequency Standard.

Frequency Correction Factor: _____ mHz

13. On the Frequency Counter, select a 1 second gate time by pressing **GATE TIME** 1 **GATE TIME**. The Frequency Counter should now display the difference between the frequency of the INPUT A signal and 10.0 MHz with a resolution of 0.01 Hz (10 mHz).

12. 10 MHz Standard Adjustment (SN 2637A and Below)

14. Remove the two adjustment cover screws from the A22 10 MHz Frequency Standard. Refer to Figure 3-53 for the location of the A22 10 MHz Frequency Standard.

Note

Do not use a metal adjustment tool to tune an oven-controlled crystal oscillator (OCXO). The metal will conduct heat away from the oscillator circuit, shifting the operating conditions.

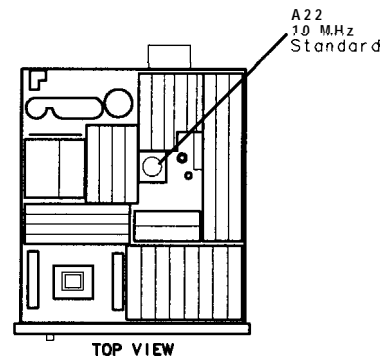

Figure 3-53. Location of 10 MHz Standard Adjustments

15. Use a nonconductive adjustment tool to adjust the 16-turn FINE frequency adjustment on the A22 10 MHz Frequency Standard for a Frequency Counter indication of 0.00 Hz. If the FINE frequency adjustment has insufficient range, center the adjustment and then adjust the COARSE frequency adjustment for a Frequency Counter indication of 0.00 Hz.
16. On the Frequency Counter, select a 10 second gate time by pressing **GATE TIME** 10 **GATE TIME**. The Frequency Counter should now display the difference between the frequency of the INPUT A signal and 10.0 MHz with a resolution of 0.001 Hz (1 mHz).
17. Wait at least 2 gate periods for the Frequency Counter to settle, and then adjust the 16-turn FINE adjustment on the A22 10 MHz Frequency Standard for a stable Frequency Counter indication of $(0.000 + \text{Frequency Correction Factor}) \pm 0.010$ Hz.
18. Replace the two adjustment cover screws on the A22 10 MHz Frequency Standard.
19. Replace the RF Section bottom cover and reconnect the short jumper cable between the FREQ REFERENCE INT and EXT connectors.

12. 10 MHz Standard Adjustment (SN 2728A and Above)

Reference

RF-Section:
A22 10 MHz Frequency Standard
A22A1 Frequency Standard Regulator
A22A2 10 MHz Quartz Crystal Oscillator

Description

The frequency of the internal 10 MHz Frequency Standard is compared to a known frequency standard and adjusted for minimum frequency error. This procedure does not adjust the short-term stability or long-term stability of the 10 MHz Quartz Crystal Oscillator, which are determined by characteristics of the particular oscillator and the environmental and warmup conditions to which it has been recently exposed. The spectrum analyzer must be ON continuously (not in STANDBY) for at least 72 hours immediately prior to oscillator adjustment to allow both the temperature and frequency of the oscillator to stabilize.

Equipment

Frequency Standard
(10 MHz with aging rate of $<\pm 1 \times 10^{-10}$) HP 5061B
Frequency Counter HP 5334A/B

Cables:

BNC cable, 122 cm (48 in) (2 required) HP 10503A

Procedure

Note

The spectrum analyzer must be ON continuously (not in STANDBY) for at least 72 hours immediately prior to oscillator adjustment to allow both the temperature and frequency of the oscillator to stabilize. Adjustment should not be attempted before the oscillator is allowed to reach its specified aging rate. Failure to allow sufficient stabilization time could result in oscillator misadjustment.

The A22A2 10 MHz Quartz Crystal Oscillator (HP P/N 10811-60111) will typically reach its specified aging rate again within 72 hours after being switched off for a period of up to 30 days, and within 24 hours after being switched off for a period less than 24 hours. If extreme environmental conditions were encountered during storage or shipment (i.e. mechanical shock, temperature extremes) the oscillator could require up to 30 days to achieve its specified aging rate.

12. 10 MHz Standard Adjustment (SN 2728A and Above)

Replacement oscillators are factory-adjusted after a complete warmup and after the specified aging rate has been achieved. Readjustment should typically not be necessary after oscillator replacement, and is generally not recommended.

1. Set the rear-panel FREQ REFERENCE switch on the spectrum analyzer RF Section to INT.

Note

The +22 Vdc STANDBY supply provides power to the heater circuit in the A22 10 MHz Frequency Standard assembly whenever line power is applied to the RF Section. This allows the A22 10 MHz Frequency Standard oven to remain at thermal equilibrium, minimizing frequency drift due to temperature variations. The OVEN COLD message should typically appear on the spectrum analyzer display for 10 minutes or less after line power is first applied to the RF Section.

Note

The rear-panel FREQ REFERENCE switch enables or disables the RF Section +20 Vdc switched supply, which powers the oscillator circuits in the A22 10 MHz Frequency Standard. This switch must be set to INT and the spectrum analyzer must be switched ON continuously (not in STANDBY) for at least 72 hours before adjusting the frequency of the A22 10 MHz Frequency Standard.

2. Set the LINE switch to ON. Leave the spectrum analyzer ON (not in STANDBY) and undisturbed for at least 48 hours to allow the temperature and frequency of the A22 10 MHz Frequency Standard to stabilize.

Note

To prolong CRT life, press **SHIFT** **[CLEAR-WRITE]**^h to turn off the CRT display while the spectrum analyzer is unattended, and **SHIFT** **[MAX HOLD]**^h to turn the CRT back on.

3. Connect the (Cesium Beam) Frequency Standard to the Frequency Counter rear-panel TIMEBASE IN/OUT connector as shown in Figure 3-54.

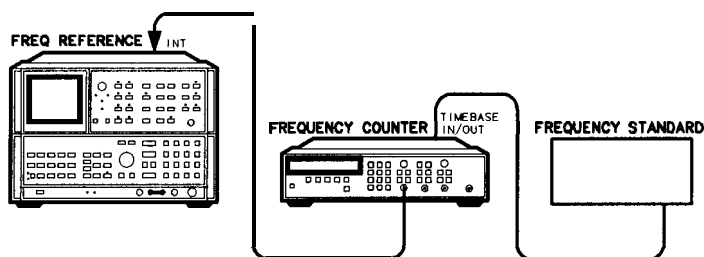

Figure 3-54. 10 MHz Frequency Standard Adjustments Setup

12. 10 MHz Standard Adjustment (SN 2728A and Above)

4. Disconnect the short jumper cable on the RF Section rear panel from the FREQ REFERENCE INT connector. Connect this output (FREQ REFERENCE INT) to INPUT A on the Frequency Counter. A REF UNLOCK message should appear on the CRT display.

5. Set the Frequency Counter controls as follows

```

FUNCTION/DATA ..... FREQ A
INPUT A:
  x10ATTN ..... OFF
  AC ..... OFF (DC coupled)
  50Ω Z ..... OFF (1 MΩ input impedance)
  AUTO TRIG ..... ON
  100 kHz FILTER A ..... OFF
  INT/EXT switch (rear panel) ..... EXT
  
```

6. On the Frequency Counter, select a 10 second gate time by pressing **[GATE TIME] 10 [GATE TIME]**. Offset the displayed frequency by - 10.0 MHz by pressing **MATH [SELECT/ENTER] [CHS/EEX] 10 [CHS/EEX] 0 [SELECT/ENTER] [SELECT/ENTER]**. The Frequency Counter should now display the difference between the frequency of the INPUT A signal (A22 10 MHz Frequency Standard) and 10.0 MHz with a displayed resolution of 1 mHz (0.001 Hz).
7. Wait at least two gate periods for the Frequency Counter to settle, and record the frequency of the A22 10 MHz Frequency Standard as reading #1.

Reading # 1: _____ mHz

Note

The A22A2 Quartz Crystal Oscillator has a typical adjustment range of 10 MHz ±10 Hz. The oscillator frequency should be within this range after 48 hours of continuous operation.

8. Allow the spectrum analyzer to remain powered (not in STANDBY) and undisturbed for an additional 24 hours.
9. Repeat steps 3 through 7 and record the frequency of the A22 10 MHz Frequency Standard as reading #2.

Reading #2: _____ mHz

12. 10 MHz Standard Adjustment (SN 2728A and Above)

10. If the difference between reading #2 and reading #1 is greater than 1 mHz, the A22 10 MHz Frequency Standard has not achieved its specified aging rate; the spectrum analyzer should remain powered (not in STANDBY) and undisturbed for an additional 24-hour interval. Then, repeat steps 3 through 7, recording the frequency of the 10 MHz Frequency Standard at the end of each 24-hour interval, until the specified aging rate of 1 mHz/day (1×10^{-9} /day) is achieved.

Reading #3: _____ mHz

Reading #4: _____ mHz

Reading #5: _____ mHz

Reading #6: _____ mHz

Reading #7: _____ mHz

11. Position the spectrum analyzer on its right side as shown in Figure 3-54, and remove the bottom cover. Typically, the frequency of the A22 10 MHz Frequency Standard will shift slightly when the spectrum analyzer is reoriented. Record this shifted frequency of the A22 10 MHz Frequency Standard.

Reading #8: _____ mHz

12. Subtract the shifted frequency reading in step 11 from the last recorded frequency in step 10. This gives the frequency correction factor needed to adjust the A22 10 MHz Frequency Standard.

Frequency Correction Factor: _____ mHz

13. On the Frequency Counter, select a 1 second gate time by pressing **GATE TIME** 1 **GATE TIME**. The Frequency Counter should now display the difference between the frequency of the INPUT A signal and 10.0 MHz with a resolution of 0.01 Hz (10 mHz).

Note

Do not use a metal adjustment tool to tune an oven-controlled crystal oscillator (OCXO). The metal will conduct heat away from the oscillator circuit, shifting the operating conditions.

14. Use a nonconductive adjustment tool to adjust the 18-turn **FREQ ADJ** capacitor on the A22A2 10 MHz Quartz Crystal Oscillator for a Frequency Counter indication of 0.00 Hz. Refer to Figure 3-55 for the location of the A22A2 10 MHz Quartz Crystal Oscillator.

12. 10 MHz Standard Adjustment (SN 2728A and Above)

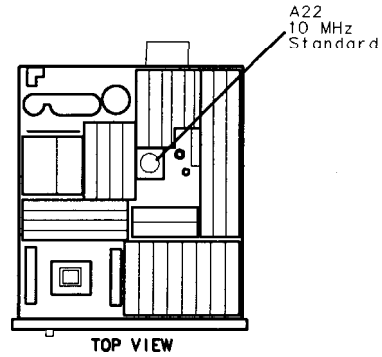

Figure 3-55. Location of 10 MHz Standard Adjustments

15. On the Frequency Counter, select a 10 second gate time by pressing **GATE TIME** 10 **GATE TIME**. The Frequency Counter should now display the difference between the frequency of the INPUT A signal and 10.0 MHz with a resolution of 0.001 Hz (1 mHz).
16. Wait at least 2 gate periods for the Frequency Counter to settle, and then adjust the **FREQ ADJ** capacitor on the **A22A2** 10 MHz Quartz Crystal Oscillator for a stable Frequency Counter indication of $(0.000 + \text{Frequency Correction Factor}) f0.010$ Hz.
17. Replace the RF Section bottom cover and reconnect the short jumper cable between the **FREQ REFERENCE INT** and **EXT** connectors.

**13. Sweep, DAC,
and Main Coil
Driver
Adjustments**

Reference

RF-Section:
A16 Scan Generator
A19 Digital-to-Analog Converter (DAC)
A20 Main Coil Driver

**Related Performance
Tests**

Center Frequency Readout Accuracy Test
Frequency Span Accuracy Test
Sweep Time Accuracy Test

Description

The Sweep Time is adjusted first by viewing the Scan Ramp on an oscilloscope and adjusting for proper levels. Next, the AUX OUT Ramp (SWEEP RECORDER OUTPUT) is adjusted to produce a continuous stepped ramp over multi-band sweeps. Offset adjustments are performed on both the A16 Scan Generator and A19 DAC Assemblies to set the start voltages of the various sweep and span ramps. The A20 Main Coil Driver Assembly is adjusted to set the two frequency end-points of the YIG-tuned oscillator. Finally, frequency span accuracy for YTO Spans (>5 MHz) is adjusted by adjusting the Sweep Attenuator gains on the A16 Scan Generator Assembly and the 5.8 and 12.5 GHz Band Overlap adjustments on the A19 DAC Assembly.

Note

Adjustments in this procedure affect YTO/YTX tracking. Adjustment Procedure 2 1, "Frequency Response Adjustments" should be performed after this procedure to ensure specified performance.

Equipment

Universal Counter HP 5316A
Synthesized Sweeper HP 8340A/B
Digitizing Oscilloscope HP 54501A
10:1 Divider Probe, 10 MHz/7.5 pF HP 10432A
Digital Voltmeter (DVM) HP 3456A
Frequency Counter HP 5343A

Adapters:

Adapter, BNC (f) to SMA (m) HP 1250-1200

Cables:

Low-Loss Microwave Test Cable (APC 3.5) HP 8120-4921

13. Sweep, DAC, and Main Coil Driver Adjustments

Procedure

1. Position the spectrum analyzer on its right side as shown in Figure 3-56, with bottom cover removed. Remove RF Digital Section cover over the A12 through A16 assemblies. Jumper A12TP2 to A12TP3 (Lock Indicator Disable).

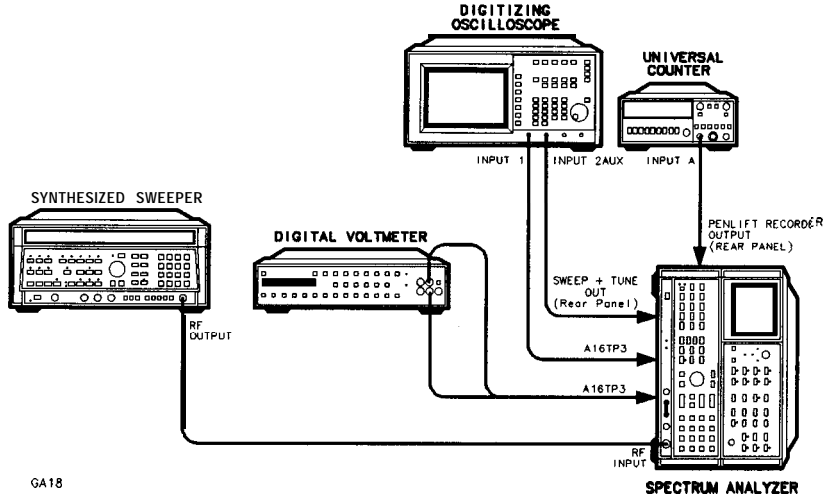

Figure 3-56. Sweep and DAC Adjustments Setup

2. Set the spectrum analyzer LINE switch to ON.
3. Key in **0--2.5 GHz**, **[SWEEP TIME] 500 ms**.
4. Connect the oscilloscope channel 1 probe to **A16TP3** (Scan Ramp). Connect rear panel **SWEEP + TUNE OUT** to the oscilloscope channel 2 input.
5. Set the oscilloscope controls as follows:

Press **(CHAN)**

Channel 1	on
probe	10:1
amplitude scale	V/div
offset3.5 V
couplingd c
Channel 2	off
amplitude scale	500 mV/div
offset-1.2 5
couplingd c
probe1:1

Press **[TRIG)**

EDGE TRIGGER	auto, edge
sourceChannel 2
level	1.375 V, rising edge

Press **(TIME BASE)**

time Scale50 ms/div
------------------	-------------

13. Sweep, DAC, and Main Coil Driver Adjustments

Press **DISPLAY**

connect dots on

Press **SHOW**

hp stopped

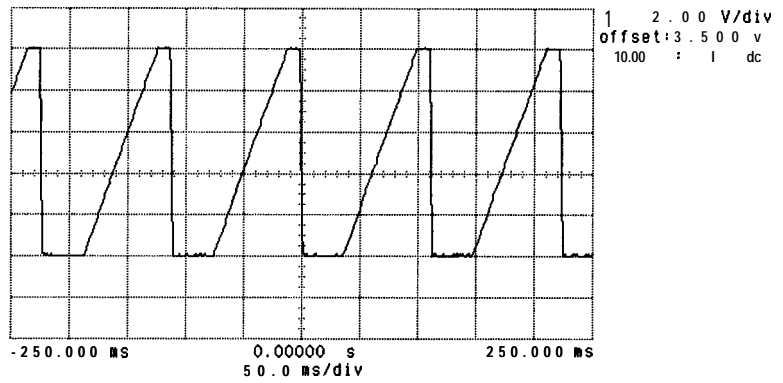

2 5 1.375 v

Figure 3-57. 0V to +10V Sweep Ramp at A16TP3

Sweep Time Adjustment (Preferred Procedure)

6. Connect universal counter INPUT A to the spectrum analyzer rear panel PENLIFT RECORDER OUTPUT.

7. Set universal counter controls as follows:

Counter modeTIA→B
 FILTER NORM/100 kHz FILTER NORM
 SEP/COM A COM A
 GATE TIME fully ccw
 Channel A/Channel B:
 Trigger Slope (A) in (negative)
 Trigger Slope (B) out (positive)
 TRIGGER LEVEL/SENSITIVITY out
 AC/DC DC
 ATTEN X1/X20 X20

8. Adjust universal counter channel A and channel B TRIGGER LEVEL controls as necessary to trigger both channels on PENLIFT RECORDER OUTPUT signal.

9. Adjust A16R67 SWEEP TIME adjustment for counter time interval indication of 500 ± 1 ms. See Figure 3-58 for the location of A16R67.

13. Sweep, DAC, and Main Coil Driver Adjustments

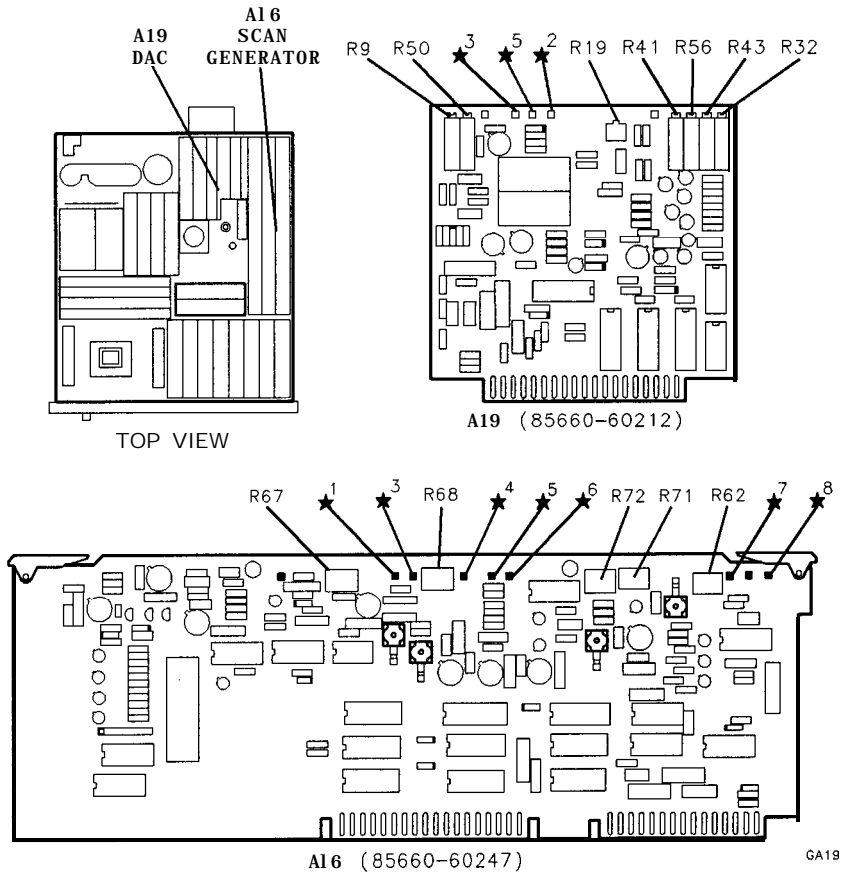

Figure 3-58. Location of Sweep and DAC Adjustments

Sweep Time Adjustment (Alternate Procedure)

Aux Out Adjustment

10. Adjust A16R67 SWEEP TIME adjustment for sweep ramp of 500 ms duration (not including dead time at beginning and end of each ramp) as measured on the oscilloscope.
11. Press **2-22 GHz**.
12. Connect the oscilloscope channel 1 to A16TP4 (AUX OUT). Display should be a stepped series of 4 sweep ramps similar to that shown in Figure 3-59.

13. Sweep, DAC, and Main Coil Driver Adjustments

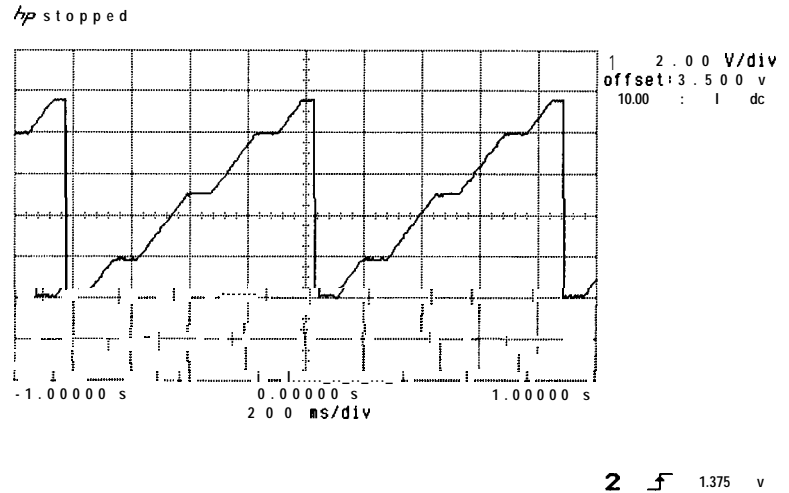

Figure 3-59. Properly Adjusted DC Levels Between Sweep Ramps

13. Adjust A16R68 AUX adjustment to align dc level of 3 dead time steps with upper dc level of each preceding sweep ramp. Refer to Figure 3-59 and Figure 3-60 for typical display of proper and improper adjustment.

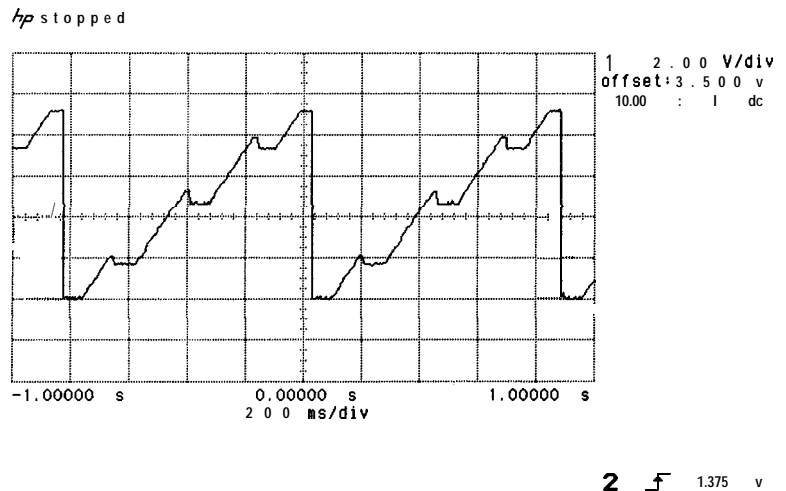

Figure 3-60. Improperly Adjusted DC Levels Between Sweep Ramps

14. Disconnect the oscilloscope (and universal counter) from the spectrum analyzer.

13. Sweep, DAC, and Main Coil Driver Adjustments

Offset and YTO DAC Adjustments

15. Perform this step only if the A16 Scan Generator is P/N 85660-60134 or 85660-60034. (HP 85660A/B with serial number prefix 2235A or below.)
 - a. Connect DVM to A16TP3 and DVM ground to A16TP1 GND.
 - b. Key in **2--22 GHz**, SWEEP (**SINGLE**), (**SHIFT**) **(RES BW)**^F (forces spectrum analyzer to reset Scan Ramp to 0 Vdc after each single sweep).
 - c. Press SWEEP (**SINGLE**).
 - d. After sweep has completed, adjust A16R74 Scan Reset OFFSET for stable DVM indication of **0.0000** f0.0005 Vdc.
 - e. Repeat steps c through d until no further adjustment is necessary.
 - f. Connect DVM to A16TP5 and DVM ground to A16TP6 GND.
 - g. Key in (**SHIFT**) **(RECALL)**, **(CENTER FREQUENCY)** 4 GHz, **(FREQUENCY SPAN)** 2.4 GHz, [**SAVE**] 1, **(FREQUENCY SPAN)** 260 MHz, [**SAVE**] 2, **(FREQUENCY SPAN)** 240 MHz, [**SAVE**] 3, **(FREQUENCY SPAN)** 80 MHz, [**SAVE**] 4.
 - h. Key in (**RECALL**) 1 and note stable DVM indication after sweep has completed.
 - i. Key in (**RECALL**) 2 and note change in stable DVM indication from previous step.
 - j. Adjust A16R75 Scan Width DAC OFFSET while alternating between (**RECALL**) 1 and (**RECALL**) 2 so that stable DVM indication varies less than 1 mVdc.
 - k. Connect DVM to A16TP8 and DVM ground to A16TP7 GND.
 - l. Key in (**RECALL**) 3 and note stable DVM indication after sweep has completed.
 - m. Key in (**RECALL**) 4 and note change in stable DVM indication from previous step.
 - n. Adjust A16R76 Integer Number Attenuator OFFSET while alternating between (**RECALL**) 3 and (**RECALL**) 4 so that stable DVM indication varies less than 1 mVdc.
16. Perform this step only if the A16 Scan Generator is P/N 85660-60188, 85660-60198, or 85660-60247. (HP 85660A/B with serial number prefix 2240A or above.)
 - a. Connect DVM to A16TP8 and DVM ground to A16TP7.
 - b. Key in **2--22 GHz**, SWEEP (**SINGLE**), (**SHIFT**) **(RES BW)**^F (forces instrument to reset Scan Ramp to 0 Vdc after each single sweep).
 - c. Press SWEEP (**SINGLE**).
 - d. After sweep is completed, adjust A16R62 RAMP OFFSET for stable DVM indication of 0.0000 ±0.0005 Vdc.
 - e. Repeat steps c through d until no further adjustment is necessary.

13. Sweep, DAC, and Main Coil Driver Adjustments

17. Perform this step only if the A19 Digital-to-Analog Converter is P/N 85660-60164 or 85660-60038. (HP 85660A/B with serial number prefix 2407A or below.)
 - a. Connect DVM to A19TP2 and DVM ground to A19 GND.
 - b. Key in (2--22 GHz), (SHIFT) (RECALL), SWEEP (SINGLE), (SHIFT) (RES BW)^F, (START FREQ) 2.5 GHz, (STOP FREQ) 4.9 GHz, (SAVE) 1, (STOP FREQ) 2.51 GHz, (SAVE) 2, (STOP FREQ) 22 GHz, (SAVE) 3, (FREQUENCY SPAN) 0 HZ, (CENTER FREQUENCY) 2.0 GHz, (SAVE) 4, (CENTER FREQUENCY) 6.2 GHz, (SAVE) 5, (CENTER FREQUENCY) 2.3 GHz, (SAVE) 6.
 - c. Key in (RECALL) 1 and note stable DVM indication after sweep has completed (approximately -7.5 Vdc).
 - d. Key in (RECALL) 2 and note change in stable DVM indication from previous step.
 - e. Adjust A19R19 Summing Amplifier OFFSET while alternating between (RECALL) 1 and (RECALL) 2 so that stable DVM indication varies less than 1 mVdc.
 - f. Key in (RECALL) 1 and note stable DVM indication after sweep has completed.
 - g. Key in (RECALL) 3 and note change in stable DVM indication from previous step.
 - h. Adjust A19R41 25 GHz SPAN OFFSET while alternating between (RECALL) 1 and (RECALL) 3 so that stable DVM indication varies less than 3 mVdc.
 - i. Key in (RECALL) 4 (to set YTO Pretune DAC to 0).
 - j. After sweep has completed, adjust A19R5 DC for stable DVM indication of -6.0000 f0.0005 Vdc.
 - k. Key in (RECALL) 5 (to set YTO Pretune DAC to 4095).
 1. After sweep has completed, adjust A19R2 AV for stable DVM indication of -18.6000 ±0.0005 Vdc.
 - m. Key in (RECALL) 6 (to set YTO Pretune DAC to 293).
 - n. After sweep has completed, readjust A19R5 DC for stable DVM indication of -6.9010 f0.0005 Vdc.
 - o. Repeat steps k through n until no further adjustments are necessary.
18. Perform this step only if the A19 Digital-to-Analog Converter is P/N 85660-60212. (HP 85660A/B with serial number prefix 2409A and above.)
 - a. Connect DVM to A19TP5 and DVM ground to A19TP3.
 - b. Key in (2--22 GHz), (SHIFT) (RECALL), SWEEP (SINGLE), (SHIFT) (RES BW)^F, (FREQUENCY SPAN) 0 HZ, (CENTER FREQUENCY) 2 GHz, (SAVE) 1, (CENTER FREQUENCY) 6.2 GHz, (SAVE) 2, (CENTER FREQUENCY) 2.3 GHz, (SAVE) 3, (START FREQ) 2.5 GHz, (STOP FREQ) 2.51 GHz, (SAVE) 4, (STOP FREQ) 5 GHz, (SAVE) 5, (STOP FREQ) 10 GHz, (SAVE) 6.

13. Sweep, DAC, and Main Coil Driver Adjustments

- c. Key in **RECALL** 1 (to set YTO Pretune DAC to 0).
- d. Adjust A19R50 for DVM indication of + 10.0000 f0.0005 Vdc.
- e. Connect DVM to A19TP2 (DVM ground to A19TP3).
- f. Key in **RECALL** 2 (to set YTO Pretune DAC to 4095).
- g. After sweep has completed, adjust A19R9 for stable DVM indication of -18.6000 ±0.0005 Vdc.
- h. Key in **RECALL** 3 (to set YTO Pretune DAC to 293).
- i. After sweep has completed, adjust A19R19 Summing Amplifier OFFSET for a stable DVM indication of -6.9010 ±0.0005 Vdc.
- j. Repeat steps f through i until no further adjustments are necessary.
- k. Key in **RECALL** 4 and note stable DVM indication after sweep has completed.
- l. Key in **RECALL** 5 and note change in stable DVM indication from previous step.
- m. Adjust A19R56 2.5 GHz SPAN OFFSET while alternating between **RECALL** 4 and **RECALL** 5 so that stable DVM indication varies less than 1 mVdc.
- n. Key in **RECALL** 4 and note stable DVM indication after sweep has completed.
- o. Key in **RECALL** 6 and note change in stable DVM indication from previous step.
- p. Adjust A19R41 25 GHz SPAN OFFSET while alternating between **RECALL** 4 and **RECALL** 6 so that stable DVM indication varies less than 1 mVdc.

YTO Main Coil Driver Adjustments (Preferred Procedure)

19. Jumper A20TP5 GND to A21TP2 and disconnect DVM from A19TP2 and A19TP3.
20. Disconnect the cable 8 (grey) from All YTO Loop Assembly at A11J10 DET OUT.
21. Connect frequency counter to front-panel 1ST LO OUTPUT as shown in Figure 3-61.

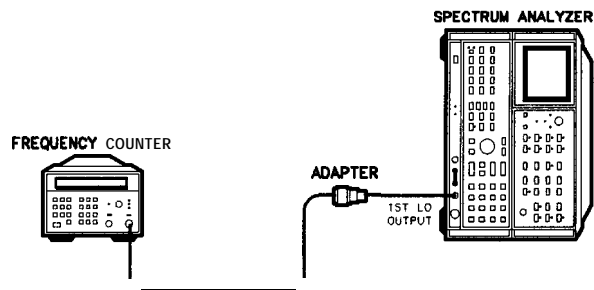

Figure 3-61. YTO Main Coil Driver Adjustments Setup

13. Sweep, DAC, and Main Coil Driver Adjustments

22. Key in (2--22 GHz), (SHIFT) (RECALL), SWEEP (SINGLE), (SHIFT) (RES BW)^F, (FREQUENCY SPAN) 0 Hz, (CENTER FREQUENCY) 2.3 GHz, (SAVE) 1, (CENTER FREQUENCY) 6.15 GHz, (SAVE) 2.
23. Key in (RECALL) 1.
24. Adjust A20R34 2.3 GHz adjustment for frequency counter indication of 2300.0 f0.1 MHz, allowing time for frequency counter display to settle. Refer to Figure 3-62 for location of adjustments.

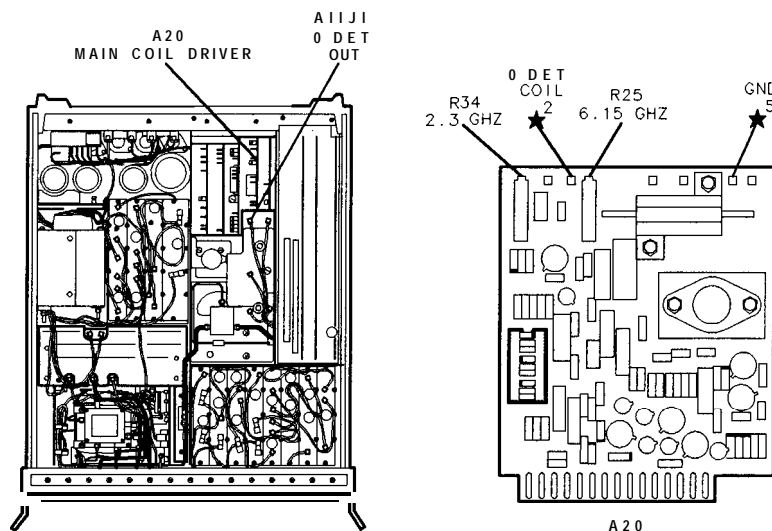

Figure 3-62. Location of YTO Main Coil Driver Adjustments

25. Key in (RECALL) 2.
26. Adjust A20R25 6.15 GHz adjustment for frequency counter indication of 6150.0 f0.1 MHz, allowing time for frequency counter display to settle.
27. Repeat steps 23 through 26 several times until no further adjustments are necessary.
28. Remove jumpers from between A20TP5 and A21TP2 and between A12TP2 and A12TP3. Reconnect cable 8 (grey) to A11J1 0 DET OUT. Disconnect frequency counter from front-panel 1ST LO OUTPUT and reconnect 50Ω load.
29. Disconnect cable 8 (grey) from A11J1 0/ DET OUT. Jumper A20TP5 GND to A21TP2 and disconnect DVM from A19TP2 and A19TP3.
30. Connect front-panel CAL OUTPUT to RF INPUT as shown in Figure 3-63.

YTO Main Coil Driver Adjustments (Alternate Procedure)

13. Sweep, DAC, and Main Coil Driver Adjustments

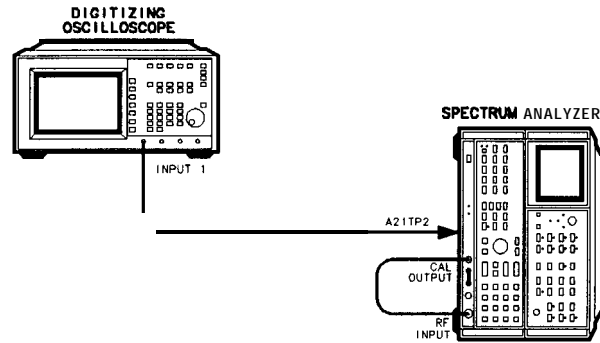

Figure 3-63.
YTO Main Coil Driver Adjustments Setup (Alternate Procedure)

31. Key in 2--22 GHz, CENTER FREQUENCY 0 Hz (Frequency Span readout should indicate 2 GHz).
32. Adjust A20R25 6.15 GHz adjustment to obtain two comb teeth (± 100 MHz harmonics of CAL OUTPUT signal) per division on display. Comb teeth should be evenly spaced but not necessarily aligned with CRT graticule lines (counterclockwise rotation of adjustment increases spacing between comb teeth).
33. Adjust A20R34 2.3 GHz adjustment to align LO feedthrough signal (0 Hz) with center CRT graticule line. It might be necessary to disconnect RF INPUT to locate LO feedthrough signal (counterclockwise rotation of adjustment moves signal to right).
34. Repeat steps 32 through 33 until comb teeth are spaced two per division and aligned with CRT graticule lines (every other comb tooth will align with a graticule line).
35. Key in CENTER FREQUENCY 2 GHz, FREQUENCY SPAN 100 MHz, RES BW 30 KHz, SAVE 1, CENTER FREQUENCY SHIFT HOLD .9 GHz, SAVE 2, CENTER FREQUENCY 2 GHz, FREQUENCY SPAN 10 MHz, RES BW 10 kHz, SAVE 3, CENTER FREQUENCY SHIFT HOLD .9GHz, SAVE 4.
36. Key in RECALL 1. With CAL OUTPUT connected to RF INPUT, at least one comb tooth should be visible on display.
37. Adjust A20R25 6.15 GHz to align nearest comb tooth with center CRT graticule line.
38. Key in RECALL 2.
39. Adjust A20R34 2.3 GHz to align nearest comb tooth with center CRT graticule line.
40. Repeat steps 36 through 39 until no further adjustments are necessary.
41. Key in RECALL 3.

13. Sweep, DAC, and Main Coil Driver Adjustments

42. Adjust **A20R25** 6.15 GHz to align nearest comb tooth with center CRT graticule line.
43. Key in **(RECALL)** 4.
44. Adjust **A20R34** 2.3 GHz to align nearest comb tooth with center CRT graticule line.
45. Repeat steps 41 through 44 until no further adjustments are necessary.
46. Reconnect cable 8 (grey) to **A11J1 0/ DET OUT**. Remove jumpers from between **A12TP2** and **A12TP3** and between **A20TP5 GND** and **A21TP2**. Connect the oscilloscope channel 1 to **A21TP2**.
47. Key in **(RECALL)** 3.
48. Adjust **A20R25** 6.15 GHz for oscilloscope indication of 0.0 f0.2 Vdc.
49. Key in **(RECALL)** 4.
50. Adjust **A20R34** 2.3 GHz for oscilloscope indication of 0.0 f0.2 Vdc.
51. Repeat steps 47 through 50 until no further adjustments are necessary.
52. Disconnect the oscilloscope from **A21TP2**.

Sweep Attenuator Gain Adjustments

53. Key in **(2-22 GHz)**, **(SHIFT)**, **(PRESEL PEAK)**, **(START FREQ)** 3928 MHz, **(STOP FREQ)** 4008 MHz.
54. Connect synthesized sweeper RF OUTPUT to front-panel RF INPUT with low-loss microwave test cable. Set synthesized sweeper for output of 4000.000 MHz at 0 dBm.
55. Signal should be visible at right side of CRT display. Press **(PEAK SEARCH)**, **MARKER (NORMAL)** to place display marker on signal peak.
56. Alternately press **(PEAK SEARCH)** and adjust **A16R72 GAIN 1** for marker frequency of 4.000 00 GHz as indicated by display annotation.

Note

If adjustment **A16R72 GAIN 1** has insufficient range, perform Adjustment Procedure 22, "Analog-To-Digital Converter Adjustments" to ensure that adjustments **A3A8R6 OFFS** and **A3A8R5 GAIN** are properly set (for a 0.00 V dc to 10.00 V dc Scan Ramp). If adjustment **A16R72 GAIN 1** still has insufficient range, check the value of factory-select precision resistor **A16R46**, which has allowable values of **74.25K** (HP Part Number 0699-0311) or **73.874K** (HP Part Number 0699-0380).

57. Key in **(START FREQ)** 3784 MHz, **(STOP FREQ)** 4024 MHz.
58. Signal should be visible at right side of CRT display. Press **(PEAK SEARCH)**, **MARKER (NORMAL)** to place display marker on signal peak.

13. Sweep, DAC, and Main Coil Driver Adjustments

59. Alternately press **[PEAK SEARCH]** and adjust A16R71 GAIN 2 for marker frequency of 4.000 GHz as indicated by display annotation.

Band Overlap Adjustments

60. Key in **[2-22 GHz]**, **[SHIFT]**, **[PRESEL PEAK]**=, **[START FREQ]** 4.5 GHz, **[STOP FREQ]** 7.1 GHz.
 61. Adjust A19R43 25 GHz SPAN and A19R32 2.5 GHz SPAN fully counterclockwise.
 62. For HP 8566A, set synthesized sweeper for output of 5.820 GHz at 0 dBm. For HP 8566B, set synthesized sweeper for output of 5.805 GHz at 0 dBm.
 63. Two separate signal peaks should be visible on display. Readjust A19R43 25 GHz SPAN until separate peaks are barely discernible from each other.
 64. Use synthesized sweeper TUNING control to vary synthesized sweeper output frequency ± 50 MHz from frequency in step 62, pressing **[PRESEL PEAK]** both times to peak preselector on each side of band overlap point.
 65. Use synthesized sweeper TUNING control to vary synthesized sweeper output frequency ± 50 MHz (from frequency in step 62) in 1 MHz steps. Readjust A19R43 25 GHz SPAN slightly as necessary so that amplitude of displayed signal peak varies less than 3 dB over entire ± 50 MHz range bracketing band overlap point.
 66. For HP 8566A, set synthesized sweeper for output of 5.800 GHz at 0 dBm. For HP 8566B, set synthesized sweeper for output of 5.800 GHz at 0 dBm.
 67. Key in **[START FREQ]** 5.55 GHz, **[STOP FREQ]** 6.05 GHz, **[RES BW]** 300 kHz.
 68. Two separate signal peaks should be visible on display. Readjust A19R32 2.5 GHz SPAN until separate peaks are barely discernible from each other.
 69. Use synthesized sweeper TUNING control to vary synthesized sweeper output frequency -5 MHz (from frequency in step 66) in 100 kHz steps. Readjust A19R32 2.5 GHz SPAN slightly as necessary so that amplitude of displayed signal peak varies less than 3 dB over entire ± 5 MHz range bracketing band overlap point.
 70. For HP 8566A, set synthesized sweeper for output of 12.520 GHz at 0 dBm. For HP 8566B, set synthesized sweeper for output of 12.510 GHz at 0 dBm.
 71. Key in **[SHIFT]**, **[PRESEL PEAK]**=, **[START FREQ]** 11.2 GHz, **[STOP FREQ]** 13.8 GHz, RES BW (AUTO).
 72. Use synthesized sweeper TUNING control to vary synthesized sweeper output frequency ± 100 MHz from frequency in step 70, pressing **[PRESEL PEAK]** both times to peak preselector on each side of band overlap point.

13. Sweep, DAC, and Main Coil Driver Adjustments

73. Use signal generator TUNING control to vary signal generator output frequency ± 100 MHz (from frequency in step 70) in 1 MHz steps. Readjust A19R43 25 GHz SPAN slightly as necessary so that amplitude of displayed signal peak varies less than 3 dB over entire ± 100 MHz range bracketing band overlap point.
74. Key in **SHIFT**, **PRESEL PEAK**=.
75. Verify that jumper between A12TP2 and A12TP3 (Lock Indicator Disable) has been removed. Replace RF Digital Section cover over A12 through A16 assemblies.

14. 100 MHz VCXO Adjustments

Reference RF-Section:
A7A2 100 MHz VCXO

Related Performance Tests Noise Sidebands Test
Residual Responses Test

Description The open loop frequency and maximum power output of the 100 MHz VCXO is centered around 100 MHz. The 400 MHz signal is adjusted for maximum 400 MHz output with minimum spurious output. The 400 MHz output is set to -10 dBm by selecting proper resistor values for the attenuator network A7A2R67, R68, and R69.

Equipment Frequency Counter HP 5343A
Spectrum Analyzer HP 8566B
Precision Power Supply HP 6114A

Adapters:
Adapter, SMB (snap-on) (m) (m) 1250-0672

Cables:
BNC to SMB Snap-On Test Cable (2 *required*) 85680-60093

Procedure

Note The A7A2 100 MHz VCXO Assembly must be installed in the RF Section with all cover screws in place during this adjustment procedure.

1. Position the spectrum analyzer on its right side as shown in Figure 3-64, and remove the bottom cover.

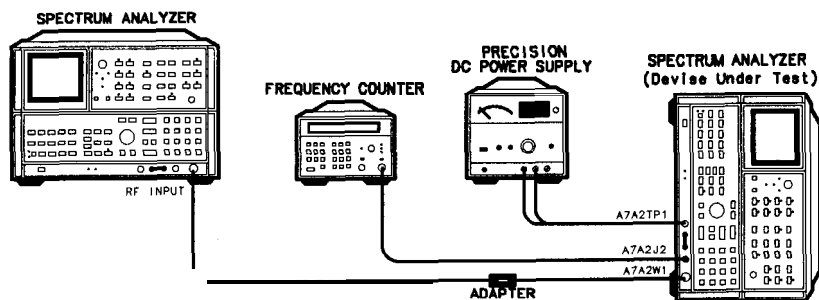

Figure 3-64. 100 MHz VCXO Adjustment Setup

2. Set the spectrum analyzer LINE switch to ON. Verify that the rear-panel FREQ REFERENCE switch is set to INT and that the

14. 100 MHz VCXO Adjustments

short BNC jumper cable W15 is connected between J2 FREQ REFERENCE EXT and J3 FREQ REFERENCE INT.

- Set the dc power supply for an output of -8 Vdc. Connect the -8 Vdc output of the dc power supply to the A7A2TP1 TUNE test point. Refer to Figure 3-65 for the location of the A7A2 100 MHz VCXO Assembly and test point A7A2TP1 TUNE.

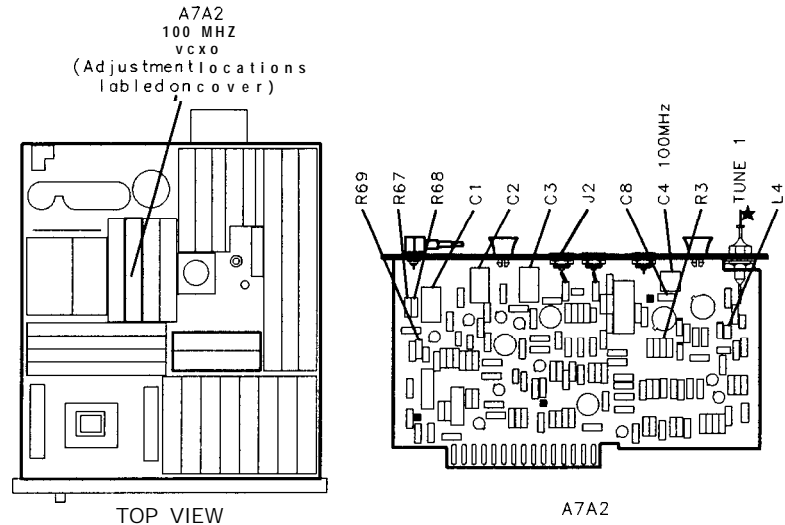

Figure 3-65. Location of 100 MHz VCXO Adjustments

- Disconnect the cable 83 (gray/orange) from A7A2J2 100 MHz OUT, and connect the RF INPUT of the second spectrum analyzer to A7A2J2 using a BNC to SMB snap-on test cable.
- Press **2--22 GHz** on the second spectrum analyzer, and then set the controls as follows:

CENTER FREQUENCY	100 MHz
FREQUENCY SPAN	3 kHz
REFERENCE LEVEL	+3 dBm
RES BW	1 kHz
LOG SCALE	1 dB/div
TRACE A	CLEAR-WRITE
TRACE B	MAX HOLD

- Adjust A7A2C4 100 MHz slowly through its full range while monitoring the display of the second spectrum analyzer. A7A2C4 100 MHz should provide enough adjustment range to shift the frequency of the 100 MHz VCXO a minimum of ± 300 Hz from 100 MHz (99.999700 MHz to 100.000300 MHz), and the output power should not vary by more than 1 dB within this range, as shown in Figure 3-66.

14. 100 MHz VCXO Adjustments

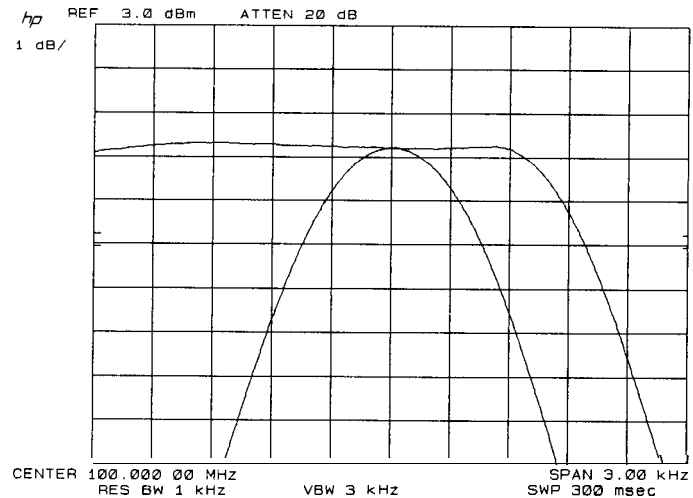

Figure 3-66. Typical Tuning Range of A7A2 100 MHz VCXO

Note

If the output power of the 100 MHz VCXO drops off by more than 1 dB within ± 300 Hz of 100 MHz, select a new value for factoryselect component A7A2L4. An increase of A7A2L4 by one standard value will shift the tuning range of the 100 MHz VCXO lower in frequency by approximately 500-600 Hz; conversely, a decrease in the value of A7A2L4 will shift the 100 MHz VCXO tuning range higher in frequency by the same amount. Refer to Table 3-7 for the acceptable range of values and corresponding HP part numbers for A7A2L4, and to Figure 3-65 for the location of A7A2L4.

Note

If A7A2C4 100 MHz does not have sufficient adjustment range to tune the 100 MHz VCXO +300 Hz to 100.000300 MHz, select a lower value for factory- selected component A7A2C8; conversely, select a higher value for A7A2C8 if A7A2C4 does not have sufficient range to tune the 100 MHz VCXO -300 Hz to 99.999700 MHz. Refer to Table 3-3 for the acceptable range of values, and to Table 3-4 for HP part numbers; refer to Figure 3-65 for the location of A7A2C8.

Table 3-7. Standard Values for A7A2L4

Value	HP Part Number
560 nH	9100-2256
470 nH	9100-2255
390 nH	9100-2254
330 nH	9100-0368
270 nH	9100-2252
220 nH	9100-2251

7. Set the controls of the second spectrum analyzer as follows:

CENTER FREQUENCY 100 MHz
 FREQUENCY SPAN200 MHz
 REFERENCE LEVEL +3 dBm
 RES BW AUTO
 LOG SCALE 10 dB/div

14. 100 MHz VCXO Adjustments

TRACE A CLEAR-WRITE
TRACE B BLANK

8. Adjust A7A2C4 100 MHz slowly through its full range while monitoring the display of the second spectrum analyzer. The output of the 100 MHz VCXO should be a single output signal near 100 MHz, with no spurious oscillations at other frequencies. If spurious oscillations are present, increase the value of factoryselected component A7A2R3 by one standard value and check again for spurious oscillations. Refer to Table 3-3 for the acceptable range of values, and to Table 3-4 for HP part numbers; refer to Figure 3-65 for the location of A7A2R3.
9. Disconnect the second spectrum analyzer from A7A2J2 100 MHz OUT, and connect the frequency counter to A7A2J2.
10. Adjust A7A2C4 100 MHz for a frequency counter indication of 100.0000 ± 0.0001 MHz (± 100 Hz).
11. Disconnect the dc power supply from the A7A2TP1 TUNE test point, and jumper A7A2TP1 TUNE to ground.
12. Verify that the frequency counter indication is less than 100.0000 MHz. If it is not, repeat, steps 3 through 11.
13. Disconnect, the jumper from A7A2TP1 TUNE and ground. Set the dc power supply for an output of -25 Vdc, and connect the -25 Vdc output of the dc power supply to A7A2TP1 TUNE.
14. Verify that the frequency counter indication is greater than 100.0000 MHz. If it is not, repeat steps 3 through 13.
15. Disconnect the dc power supply from A7A2TP1 TUNE, and reconnect the cable 83 (gray/orange) to A7A2J2 100 MHz OUT.

400 MHz Output Adjustment

16. Disconnect the cable 96 (white/blue) from A7A3J1 400 MHz IN, and connect this cable to the RF INPUT of the second spectrum analyzer using a BNC-to-SMB snap-on test cable and an SMB male-to-male adapter.
17. Set the controls of the second spectrum analyzer as follows:

CENTER FREQUENCY 500 MHz
FREQUENCY SPAN 1 GHz
REFERENCE LEVEL -7 dBm
RES BW AUTO
LOG SCALE 10 dB/div
TRACE A CLEAR-WRITE
18. The 400 MHz output signal should be visible on the display of the second spectrum analyzer, along with other harmonics of 100 MHz. Adjust the A7A2C3, A7A2C2, and A7A2C1 400 MHz adjustments in sequence to maximize the power level of the 400 MHz output signal and minimize all other harmonics of 100 MHz. Be sure to perform the adjustments in the proper sequence; it might be necessary to repeat the sequence more than once.
19. Note the level of any 100 MHz harmonics displayed on the second spectrum analyzer relative to the power level of the 400 MHz

14. 100 MHz VCXO Adjustments

output signal. Verify that the 100 MHz harmonics do not exceed the levels listed in Table 3-8

Table 3-8. Limits for 100 MHz Harmonics

Harmonic Frequency	Maximum Allowable Level
100 MHz	-40 dBc
200 MHz	-25 dBc
300 MHz	-40 dBc
(400 MHz)	(0 dBc)
500 MHz	-40 dBc
600 MHz	-40 dBc
700 MHz	-40 dBc
800 MHz	-15 dBc
>800 MHz	-40 dBc

20. Set the controls of the second spectrum analyzer as follows:

CENTER FREQUENCY 400 MHz
 FREQUENCY SPAN 1 kHz
 REFERENCE LEVEL -7 dBm
 RES BW 300 Hz
 LOG SCALE 1 dB/div

21. Slightly readjust the A7A2C3, A7A2C2, and A7A2C1 400 MHz adjustments in sequence to maximize the power level of the 400 MHz output signal, and then verify that the maximized power level of the 400 MHz output signal is -10 dBm \pm 2 dB. If it is not, note the amplitude and change the values of attenuator network resistors A7A2R67, A7A2R68, and A7A2R69 as necessary. Table 3-9 contains a list of attenuations in 1-dB steps and the corresponding

values for the attenuator resistors to adjust the 400 MHz output power level to -10 dBm. Refer to Table 3-10 for HP part numbers, and to Figure 3-65 for the location of A7A2R67, A7A2R68, and A7A2R69.

Table 3-9.
Selection Chart for Attenuator Resistors

Attenuation (dB)	Resistors		
	R67	R68	R69
0	open	short	open
-1	825	6.8	825
-2	422	12.1	422
-3	261	17.8	261
-4	215	23.7	215
-5	178	31.6	178
-6	147	38.3	147
-7	133	46.4	133
-8	121	51.1	121
-9	110	61.9	110

14. 100 MHz VCXO Adjustments

Table 3-10. Resistor Values

Resistor	HP Part Number
6.8	0683-0685
12.1	0757-0379
17.8	0757-0294
23.7	0698-343 1
31.6	0757-0180
38.3	0698-3435
46.4	0698-4037
51.1	0757-0394
61.9	0757-0276
110	0757-0402
121	0757-0403
133	0698-3437
147	0698-3438
178	0698-3439
215	0698-3441
261	0698-3132
422	0698-3447
825	0757-042 1

22. Set the controls of the second spectrum analyzer as follows:

CENTER FREQUENCY 400 MHz
 FREQUENCY SPAN 50 MHz
 REFERENCE LEVEL -7 dBm
 LOG SCALE 10 dB/div
 RES BW 30 kHz
 VIDEO BW 10 kHz

23. Check for 10 MHz sidebands on the 400 MHz output signal at 390 MHz and 410 MHz. If 10 MHz sidebands are visible, they should be greater than 70 dB down (>-70 dBc) from the power level of the 400 MHz output signal.

24. Disconnect the second spectrum analyzer from the A7A2 100 MHz VCXO Assembly. Reconnect the cable 96 (white/blue) to A7A3J1 400 MHz IN.

15. M/N Loop Adjustments

Reference RF-Section:
A7A4 M/N Output

Description The M/N VCO tuning range end points and output level are set and checked to ensure an adequate RF output level across the tuning range of the M/N phase-lock loop.

Equipment

Frequency Counter	HP 5343A
Spectrum Analyzer	HP 8566B
Digital Voltmeter (DVM)	HP 3456A
Precision Power Supply	HP 6114A
15x2 Extender Board (<i>service accessory</i>)	08505-60041

Adapters:
Adapter, SMB Male-to-Male (*service accessory*) 1250-0669

Cables:
BNC to SMB Test Cable (*service accessory*)085680-60093

- Procedure**
1. Position the spectrum analyzer on its right side as shown in Figure 3-67. Remove the bottom cover of the RF Section.
 2. Connect the frequency counter's rear-panel 10 MHz FREQ STD OUT connector to the RF Section's rear-panel FREQ REFERENCE EXT connector. See Figure 3-67. Set the RF Section's rear-panel switch to EXT.
 3. Connect a jumper between A12TP2 and A12TP3 (LOCK INDICATOR DISABLE) in the RF Section. Refer to Figure 3-68 for the location of A12TP2 and A12TP3.

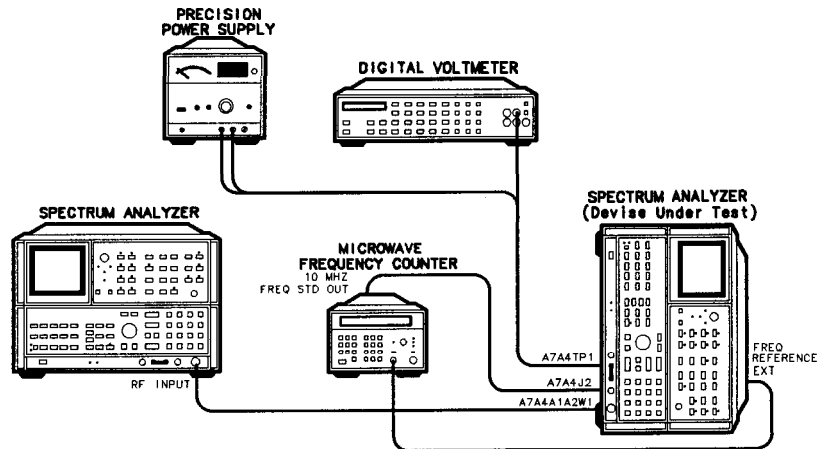

Figure 3-67. M/N Loop Adjustment Setup

15. M/N Loop Adjustments

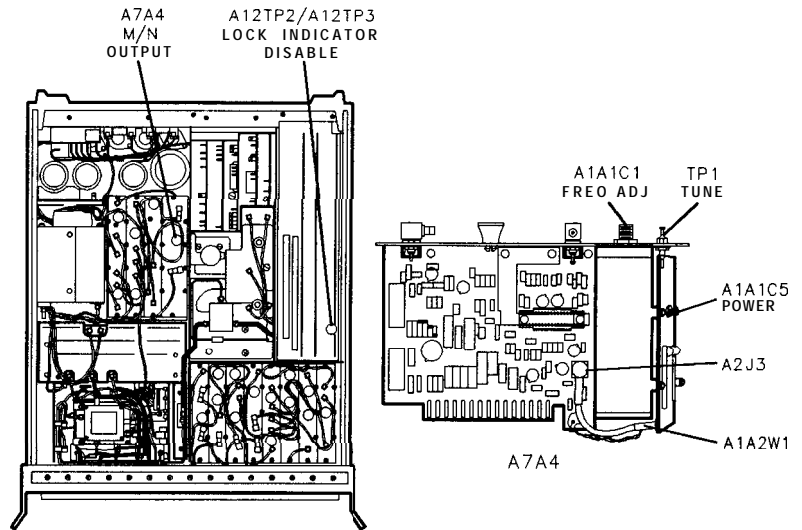

Figure 3-68. Location of PLL Adjustments

4. Disconnect the cable 93 (white/orange) from A7A4J2 M/N OUT in the RF Section. Refer to Figure 3-68 for the location of the A7A4 M/N Output Assembly.
5. Connect the frequency counter BNC input to A7A4J2 M/N OUT using a BNC to SMB Snap-on Test Cable. Set the input selector switch on the frequency counter to **10 HZ - 500 MHZ**, and set the impedance switch to **50 Ω**.
6. Set the RF Section LINE switch to ON and press **2-22 GHz**. Key in **(SHIFT) (RES BW)^F, (CENTER FREQUENCY) 6090.000 MHz, (FREQUENCY SPAN) 0 Hz**. The frequency counter indication should be 197.419355 MHz ±1 count.
7. Connect the DVM to A7A4TP1 TUNE test point.
8. Adjust A7A4A1A1C1 FREQ ADJ tuning slug for a DVM indication of -35.0 ±0.5 Vdc. Slightly loosen the hex locking nut before adjusting the FREQ ADJ tuning slug, and tighten the nut after the appropriate voltage is set.
9. Key in **(CENTER FREQUENCY) 2100.000 MHz** on the RF Section. The frequency counter indication should be 177.500000 MHz ±1 count, and the DVM indication should be -2.3 ±0.5 Vdc.
10. Set the RF Section LINE switch to STANDBY.
11. Disconnect the frequency counter and DVM from the A7A4 M/N Output Assembly.
12. Disconnect the cable 92 (white/red) from A7A4J1 355-395 MHz OUT on the A7A4 M/N Output Assembly. Remove the A7A4 M/N Output Assembly from the RF Section, and install it on an extender board.
13. Press **2-22 GHz** on the second spectrum analyzer. Connect the CAL OUTPUT signal to the RF INPUT on the second spectrum analyzer, and press **RECALL 8**.

15. M/N Loop Adjustments

14. Adjust the AMPTD CAL control on the second spectrum analyzer for a -10.00 dBm displayed signal, and then press (SHIFT) **FREQUENCY SPAN**^W.
15. Set the controls of the second spectrum analyzer as follows:
CENTER FREQUENCY 375 MHz
FREQUENCY SPAN 100 MHz
REFERENCE LEVEL +5 dBm
LOG SCALE 2 dB/DIV
16. Disconnect the cable 9 (white) A7A4A1A2W1 from A7A4A2J3 on the A7A4 M/N Output Assembly. Refer to Figure 3-68 for the location of A7A4A1A2W1 and A7A4A2J3. Use an SMB male-to-male adapter and a BNC to SMB Snap-on Test Cable to connect the white cable to the input of the second spectrum analyzer.
17. Set the RF Section LINE switch to ON.

Caution

Damage might occur to the M/N VCO tuning diodes on A7A4 M/N Output Assembly if a positive voltage is applied to A7A4TP1 TUNE test point.

18. Set the dc power supply for an output of -35.0 ± 0.5 Vdc.
Connect the positive lead of the dc power supply to the RF Section chassis (ground). Then, connect the negative lead to A7A4TP1 TUNE test point.
19. Adjust A7A4A1A1C5 PWR for an M/N VCO output level of 0.0 dBm \pm 2.0 dB as indicated on the second spectrum analyzer display. Refer to Figure 3-68 for the location of A7A4A1A1C5 PWR adjustment.
20. Slowly reduce the output voltage of the dc power supply from -35.0 Vdc to -2.3 Vdc while monitoring the M/N VCO output level displayed on the second spectrum analyzer. The M/N VCO output level at A7A4A2J3 should be greater than -2.0 dBm between 355 MHz (-2.3 Vdc) and 395 MHz (-35 Vdc).
21. Set the RF Section LINE switch to STANDBY.
22. Reconnect the white cable to A7A4A2J3 on the A7A4 M/N Output Assembly, and then reinstall the A7A4 M/N Output Assembly in the RF Section. Reconnect the cable 92 (white/red) to A7A4J1 355-395 OUT.
23. Repeat steps 5 through 11.
24. Reconnect the cable 93 (white/orange) to A7A4J2 M/N OUT.
25. Remove the LOCK INDICATOR DISABLE jumper from A12TP2 and A12TP3. Disconnect the frequency counter from the RF Section rear-panel FREQ REFERENCE INT connector, and reconnect the short jumper cable between the FREQ REFERENCE INT and EXT connectors. Set the RF Section rear-panel switch to INT.

16. YTO Loop Adjustments

Reference RF-Section:
 A1 1A5 Sampler
 A11A2 YTO Loop Interconnect

Related Performance Tests Average Noise Level Test

Description The output power level of the A11A1 Coupler/Isolator/Amplifier (CIA) is checked over the 2.2 GHz to 6.2 GHz tuning range of the All YTO Loop, and the A1 1A3 YTO is tuned to the minimum power frequency. Then, the CIA GATE BIAS is adjusted for a -5.0 dBm output power level at the coupled output of the A11A1 CIA. The YTO Loop A11A5 Sampler is driven by a synthesized sweeper and the dc output of Sampler A1 1U1 is monitored with an oscilloscope. The Sampler Driver circuit is adjusted for maximum amplitude and flatness over the range of the M/N Loop. The YTO Loop Sampler IF amplifiers are then adjusted for correct output level and frequency response.

Equipment

Spectrum Analyzer	HP 8566B
Synthesized Sweeper	HP 8340A/B
Digitizing Oscilloscope	HP 54501A
Power Meter/Power Sensor	HP 436A/8481A
SMA (m) 50 ohm Termination	1810-0118

Adapters:

Type N (m) to APC 3.5 (f) Adapter	1250-1744
Adapter, BNC to Alligator Clip	1250-1292

Cables:

Low-loss Microwave Test Cable, APC 3.5	8120-4921
BNC TO SMB Snap-On Test Cable (2 required)	85680-60093

- Procedure**
1. Set the spectrum analyzer (DUT) LINE switch to STANDBY. Turn the spectrum analyzer over to position the RF Section on top, as shown in Figure 3-69. Remove the RF Section's bottom cover.
 2. Disconnect semi-rigid coax cable W11 from A11A1 CIA Assembly's YTO OUT connector. Disconnect the opposite end of W11 from AT2 (for RF Sections 2526A and below, disconnect from cable A6W6). See Figure 3-70 for the location of A11A1, W11, A6W6, and AT2.

16. YTO Loop Adjustments

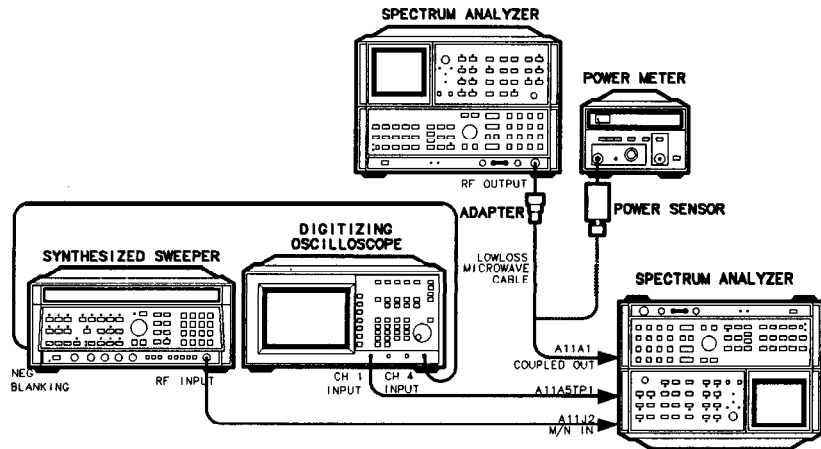

Figure 3-69. YTO Loop Adjustment Setup

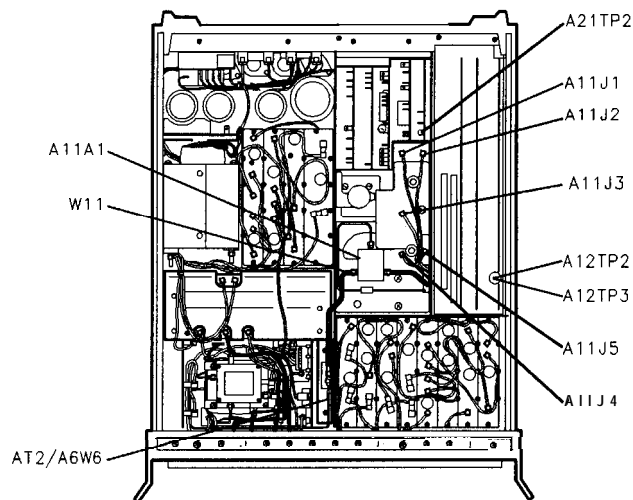

Figure 3-70. Location of Assemblies, Cables, and Test Points

3. On the All YTO Loop Assembly, disconnect the cable 8 (gray) from A11J1 PHASE DET OUT, the cable 93 (white/orange) from A11J2 M/N IN, and the cable 5 (green) from A11J3 20/30 IN. Disconnect cable 0 (black) from A11J4 IF IN and A11J5 IF OUT. See Figure 3-70.
4. Connect a jumper between A12TP2 and A12TP3 (LOCK INDICATOR DISABLE) on the A12 Front Panel Interface Assembly in the RF Section. Connect a jumper between A21TP2 TUNE VOLTAGE and the RF Section chassis ground. See Figure 3-70.
5. Install the All YTO Loop Assembly in the Service Position by removing the three screws (marked with the letter A) securing the A1 1 YTO Loop Assembly in the RF Section. Figure 3-71 shows the All service position. Grasp the two metal extractors on the All assembly, and slide the assembly upwards until it just clears the RF Section. Rotate the assembly 90° towards the front of the RF Section and secure the Servicing Support Screw to the threaded

16. YTO Loop Adjustments

mounting hole located on the chassis divider next, to the A10A1 PLL1 VCO Assembly.

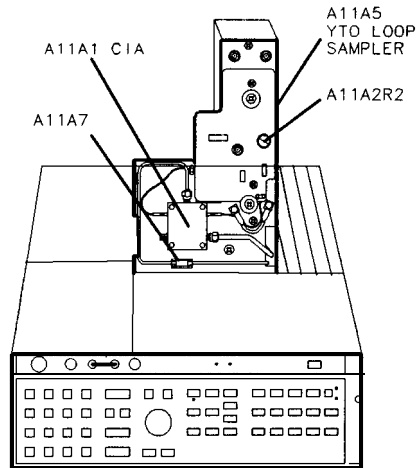

Figure 3-71. All YTO Loop Service Position

6. Remove the SMA 50 ohm termination from the RF Section frontpanel 1ST LO OUTPUT connector. Install the termination on the YTO OUT connector of A1 1A1 CIA Assembly.

CIA Gate Bias Adjustment

Note

A1 1A7 6.20 GHz Lowpass Filter/Attenuator/Cable Assembly and semirigid cable W 11 can both be damaged if the semi-rigid coax cable is bent excessively in the following steps.

7. Disconnect A1 1A7 6.20 GHz Lowpass Filter/Attenuator/Cable Assembly from the COUPLED OUT connector of A11A1 CIA Assembly. See Figure 3-71 for the location of A11A7.
8. Carefully unclip A11A7 from the YTO Loop cover allowing the cable's free end to be moved to one side.
9. Connect the SMA male end of W11 to the COUPLED OUT connector of A11A1 CIA Assembly. (W11 was removed from the YTO OUT connector in step 2.)
10. Connect a low-loss microwave test cable to the RF INPUT of the second spectrum analyzer using a Type N to APC 3.5 adapter. Connect the opposite end of the cable to the SMA female end of W11 (on the COUPLED OUT connector of A11A1 CIA Assembly).
11. On the RF Section, adjust A11A2R2 GATE BIAS ADJ fully counterclockwise. See Figure 3-71 for the location of A11A2R2.
12. Press **2-22 GHz** on the second spectrum analyzer. Set the controls of the second spectrum analyzer as follows:

START FREQUENCY	2.2 GHz
STOP FREQUENCY	6.2 GHz

16. YTO Loop Adjustments

REFERENCE LEVEL+5 dBm
LOG SCALE 10 dB/DIV

13. Set the Spectrum Analyzer (DUT) LINE switch to ON, and key in [FREQUENCY SPAN] 0 Hz, [CENTER FREQUENCY] 5.6786 GHz. This tunes the A11A3 YTO to approximately 6.00 GHz.
14. On the second spectrum analyzer, key in (SHIFT) TRACE A [MAX HOLD], (SHIFT) [GHz] /, [PEAK SEARCH] to position a marker on the peak of the displayed 6.00 GHz signal. Press [PRESEL PEAK] on the second spectrum analyzer, and wait for the preselector peaking routine to complete.
15. On the Spectrum Analyzer (DUT), key in [CENTER FREQUENCY] 3.6786 GHz. This tunes the A11A3 YTO to approximately 4.00 GHz.
16. On the second spectrum analyzer, key in [PEAK SEARCH] to position a marker on the peak of the displayed 4.00 GHz signal. Press [PRESEL PEAK] on the second spectrum analyzer and wait for the preselector peaking routine to complete.
17. On the second spectrum analyzer, key in LOG SCALE [ENTER dB/DIV] 2 dB, TRACE B [CLEAR-WRITE], TRACE B [MAX HOLD], (SHIFT) [GHz] /.
18. On the spectrum analyzer (DUT), key in SWEEP (SINGLE), [SWEEP TIME] 200 sec, (SHIFT) SWEEP [CONT] . A "HARMONIC LOCK 1" message should appear on the CRT display of the spectrum analyzer (DUT).
19. On the spectrum analyzer (DUT), key in [START FREQUENCY] 1.8786 GHz, [STOP FREQUENCY] 5.8786 GHz, [SAVE] 4, SWEEP [SINGLE]. This tunes the A11A3 YTO from approximately 2.20 GHz to 6.20 GHz. Wait for the sweep to complete (200 seconds) and the SWEEP LED to turn off.
20. On the Spectrum Analyzer (DUT), key in [FREQUENCY SPAN] 0 Hz, [CF STEP SIZE] 100 MHz, [CENTER FREQUENCY]. Using the DATA knob and step keys, tune the A11A3 YTO to position the TRACE A signal at the lowest point on the TRACE B waveform on the display of the second spectrum analyzer. See Figure 3-72. Key in [SAVE] 5 on the Spectrum Analyzer (DUT).

16. YTO Loop Adjustments

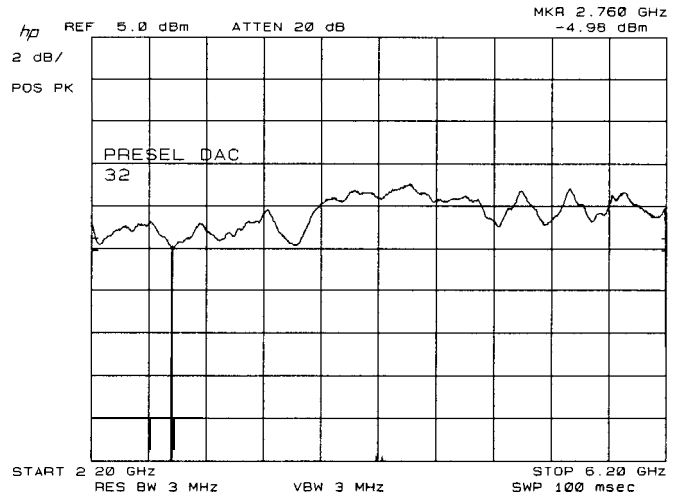

Figure 3-72.
Typical YTO Loop Swept Frequency Response at A11A1

21. On the second spectrum analyzer, key in [PEAK SEARCH] to position a marker on the peak of the TRACE A displayed signal. Press [PRESEL PEAK] on the second spectrum analyzer and wait for the preselector peaking routine to complete.
22. On the Spectrum Analyzer (DUT), key in [RECALL] 4 and wait for the sweep to complete (200 seconds) and the SWEEP LED to turn Off.
23. On the Spectrum Analyzer (DUT), key in [RECALL] 5, [CENTER FREQUENCY]. Use the DATA knob to tune the A11A3 YTO to position the TRACE A signal at the lowest point on the TRACE B waveform on the display of the second spectrum analyzer, as shown in Figure 3-72.
24. Repeat steps 21 through 23 as necessary until the lowest point in the TRACE B waveform does not change.
25. On the spectrum analyzer (DUT), key in [SHIFT] [MKR → REF LVL] ^R to activate the Frequency Diagnostics function. Six lines of numerical data should appear in the upper left corner of the spectrum analyzer CRT; the top line is the 10 digit YTO Start Frequency, ranging from 2.000 000 000 GHz to 6.200 000 000 GHz. Note the currently-selected YTO Start Frequency (the minimum power frequency of the All YTO Loop). This frequency should be approximately the same as the marker frequency displayed on the second spectrum analyzer.

All YTO Loop Minimum Power Frequency:
_____ GHz

26. Disconnect the low-loss microwave test cable from the SMA female end of W11 and from the RF INPUT of the second spectrum analyzer.
27. Connect the power sensor to the power meter's POWER REF output, and zero and calibrate the power meter. Determine the power sensor cal factor for the A1 1 YTO Loop Minimum Power

16. YTO Loop Adjustments

Frequency determined in step 25, and set the power meter CAL FACTOR control accordingly. Connect the power sensor to the SMA female end of W 11 (W 11 should still be connected to the COUPLED OUT connector of A11A1 CIA Assembly).

28. Adjust A11A2R2 GATE BIAS ADJ for a power meter indication of -5.0 dBm f0.1 dB.
29. Disconnect the power sensor from semi-rigid coax cable W11. Disconnect semi-rigid coax cable W 11 from the COUPLED OUT connector of A11A1 CIA Assembly, and reconnect A11A7 to the A11A1 CIA Assembly.

YTO Sampler Adjustments

30. Remove the cover from A11A5 YTO Loop Sampler Assembly. Locate DRIVER MATCHING adjustments A1 1A5C1 and A1 1A5C2, SAMPLER DC test point A11A5TP1, and IF GAIN adjustment A11A5R1. These parts are indicated on the cover of the A11A5 YTO Loop Sampler Assembly and in Figure 3-73.

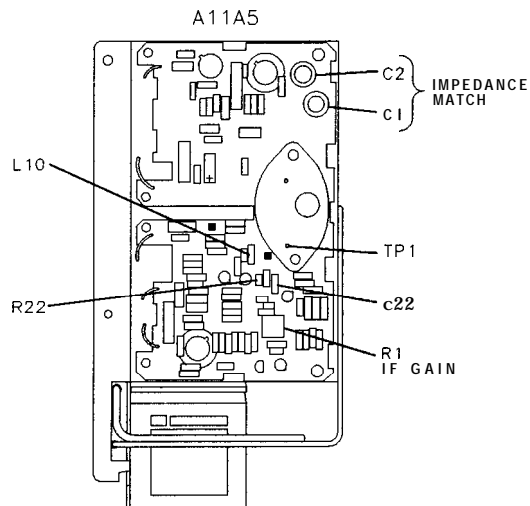

Figure 3-73. A1 1A5 Adjustment Locations

31. On the oscilloscope, key in **RECALL** **CLEAR** to perform a soft reset.

16. YTO Loop Adjustments

32. Set the oscilloscope controls as follows:

Press **[CHAN]**:

Channel 1on
amplitude scale 200 mV/div
offset-300.000 mV
couplingdc
Channel 4on
amplitude scale2.00 V/div
offset0.00000 V
couplingdc

Press **[TRIG]**:

EDGE TRIGGER trig'd, edge
source Channel 4
level-3.00000 V, rising edge

Press **[TIME BASE]**:

time scale 2.00 msec/div
referenceleft

Press **[DISPLAY]**:

connect dotson
--------------	---------

Press **[SHOW]**

33. Press **[INSTR PRESET]** on the synthesized sweeper. Set the synthesized sweeper controls as follows:

START FREQUENCY 87.5 MHz
STOP FREQUENCY 287.5 MHz
POWER LEVEL +3.0 dBm
FREQUENCY MARKER M1 160 MHz
FREQUENCY MARKER M2 210 MHz
FREQUENCY MARKER M3 187.5 MHz
SWEEP TIME 20 ms
AMPTD MKR on

34. Connect the RF OUTPUT of the synthesized sweeper to AllJ2 M/N IN using a BNC to SMB snap-on test cable.
35. Use a BNC to alligator clip adapter to connect the oscilloscope Channel 1 input to the RF Section A11A5TP1 test point, and connect the Channel 1 ground to the All YTO Loop cover. Connect the oscilloscope Channel 4 input to the synthesized sweeper rear-panel NEG BLANKING output. Adjust the oscilloscope triggering as necessary for a stable display, and then key in **[CHAN]** Channel 4 off, **[SHOW]**.
36. The A11A5TP1 SAMPLER DC waveform displayed on the oscilloscope should be similar to Figure 3-74. The left, middle, and right vertical spikes visible on the voltage waveform correspond to synthesized sweeper marker frequencies of 160 MHz, 187 MHz, and 210 MHz, respectively. Adjust A11A5C2 to widen the waveform as far to the left as possible.

16. YTO Loop Adjustments

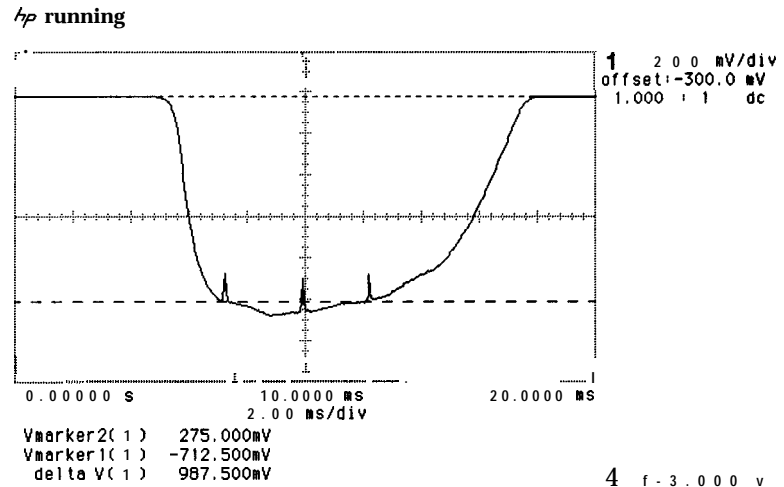

Figure 3-74. Sampler Waveform at A11A5TP1

37. Adjust A11A5C1 for a minimum voltage level at the 210 MHz (right) marker. Readjust A11A5C2 to make the voltages at the 160 MHz (left) and 210 MHz (right) markers equally negative. Carefully readjust A11A5C1 and A11A5C2 as necessary for maximum flatness and lowest possible voltage of the displayed waveform between the 160 MHz and 210 MHz markers.
38. On the oscilloscope, press $\Delta T \Delta V$, and turn on the voltage markers for the Channel 1 input. Place one voltage marker at the level of the 160 MHz (left) and 210 MHz (right) markers, and place the second voltage marker at the maximum voltage level of the displayed waveform, as shown in Figure 3-74. The voltage level of the displayed waveform between the 160 MHz and 210 MHz markers should be a minimum of 0.50 Vdc lower than the maximum voltage level.
39. Disconnect the oscilloscope's Channel 1 input from A11A5TP1 SAMPLER DC.
40. On the spectrum analyzer (DUT), note the fourth line of numerical data appearing in the upper left corner of the spectrum analyzer CRT; this is the g-digit M/N Loop Frequency, ranging from 177.500 000 MHz to 197.419 355 MHz. Note the currently selected M/N Loop Frequency (corresponding to the minimum power YTO Start Frequency from step 25).

16. YTO Loop Adjustments

All YTO Loop Frequency: _____ MHz

41. On the synthesized sweeper, press **CW** and key in the M/N Loop Frequency from step 40.
42. Press **2-22 GHz** on the second spectrum analyzer. Connect the CAL OUTPUT signal on the second spectrum analyzer to the RF INPUT on the second spectrum analyzer, and press **RECALL 8**.
43. Adjust the AMPTD CAL control on the second spectrum analyzer for a -10.00 dBm displayed signal. Then, key in **2-22 GHz**, **SHIFT** **FREQUENCY SPAN** **W** on the second spectrum analyzer and wait for the self-correction routine to complete. Key in **SHIFT** **TRACE A** **MAX HOLD** on the second spectrum analyzer.
44. Use a second BNC to SMB snap-on test cable to connect the RF INPUT of the second spectrum analyzer to AllJ5 IF OUT.
45. Set the controls of the second spectrum analyzer as follows:

START FREQUENCY	5 MHz
STOP FREQUENCY	70 MHz
REFERENCE LEVEL	+ 10 dBm
LOG SCALE	10 dB/DIV
RESOLUTION BW	300 kHz
46. The IF OUT fundamental and second harmonics should be visible at approximately 30 MHz and 60 MHz on the display of the second spectrum analyzer, as shown in Figure 3-75. Key in **MARKER** **NORMAL** 30 MHz to position a marker at 30.03 MHz on the display of the second spectrum analyzer.

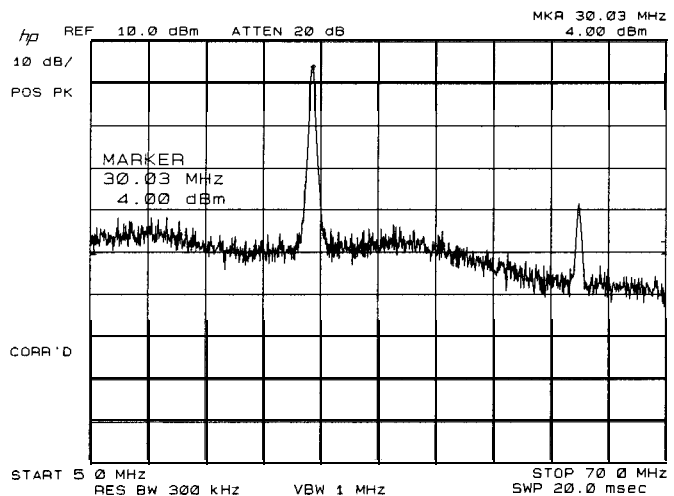

Figure 3-75.
30 MHz YTO Loop Sampler Response at A 1155 IF OUT

47. On the Spectrum Analyzer (DUT), turn the DATA knob as necessary to tune the IF OUT fundamental to 30.0 MHz \pm 0.5 MHz, as indicated by the marker on the display of the second spectrum analyzer.

16. YTO Loop Adjustments

48. On the second spectrum analyzer, key in **(ENTER dB/DIV)** 2 dB, **(RES BW)** 3 MHz, **MARKER (NORMAL)**, **(PEAK SEARCH)** to position a marker on the peak of the displayed 30 MHz fundamental signal. Adjust **A11A5R1** IF GAIN for an IF OUT power level (the 30 MHz fundamental signal) of +4.0 dBm.

Note

If **A11A5R1** IF GAIN does not have sufficient adjustment range, change the value of factory-select component **A11A5L10**. An increase in the value of **A11A5L10** will increase the IF OUT power level at **A11J5** IF OUT. Refer to Table 3-3 for the acceptable range of values for **A11A5L10**, and to Table 3-4 for HP part numbers. See Figure 3-73 for the location of **A11A5L10**.

49. On the second spectrum analyzer, press **TRACE A (MAX HOLD)**, **TRACE B (CLEAR-WRITE)**.
50. On the synthesized sweeper, key in **(SHIFT) (CW) (↑) (↑)** to set the CW RES to 0.001 MHz. Then, use the **ENTRY** knob to gradually tune the synthesized sweeper up and down from the frequency set in step 41, tuning the IF OUT fundamental (displayed on the second spectrum analyzer) from 5 MHz to 70 MHz as shown in Figure 3-76.

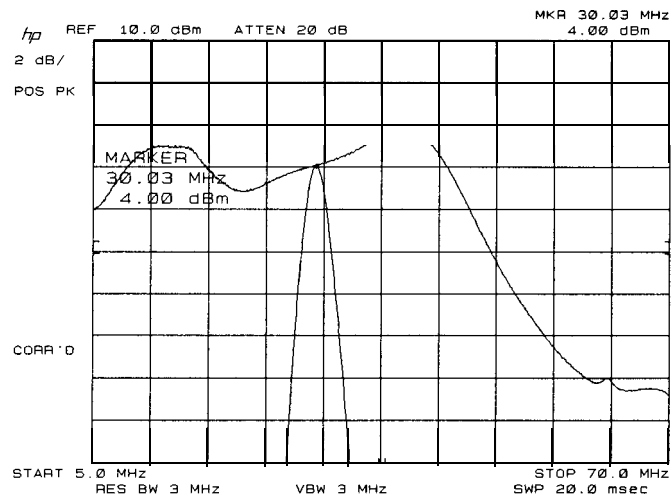

Figure 3-76. Tuning the IF OUT Fundamental

51. On the second spectrum analyzer, press **MARKER (NORMAL)**, and use the **DATA** knob to verify the power level of the displayed fundamental signal over the frequency ranges listed in Table 3-11.

Table 3-11. Power Level of Fundamental Signal

Frequency Range	Power Level
5 MHz to 20 MHz	-3 dBm > power level ≤ + 10 dBm
20 MHz to 30 MHz	+ 2 dBm > power level ≤ + 6 dBm
30 MHz to 70 MHz	-10 dBm > power level < + 10 dBm

Note

If the power level of the displayed fundamental below 20 MHz is too low, decrease the value of factory-select component **A11A5C22**. If the power level of the displayed fundamental between 20 MHz and 30 MHz is too low, decrease the value of factory-select component **A11A5R22**. If the power level of the displayed fundamental above 30 MHz is too high, increase the value of factory-select component **A11A5L10**. Refer to **Table 3-3** for the acceptable range of values for **A11A5C22**, **A11A5R22**, **A11A5L10**, and to **Table 3-4** for HP part numbers. See **Figure 3-73** for the location of **A11A5C22**, **A11A5R22**, and **A11A5L10**.

52. Set the Spectrum Analyzer (DUT) LINE switch to STANDBY. Disconnect the second spectrum analyzer from the RF Section **A11J5 IF OUT**. Disconnect the synthesized sweeper from the RF Section **A11J2 M/N IN**.
53. Replace the cover on **A11A5** YTO Loop Sampler Assembly. Loosen the Servicing Support Screw holding the All YTO Loop Assembly in the Service Position. Grasp the two metal extractors on the All YTO Loop Assembly and slide the assembly back into the RF Section, mating the two guide pins with the corresponding guide sleeves on the A23 Motherboard Assembly. Replace the three screws (marked with the letter A) securing the All YTO Loop Assembly in the RF Section.
54. Reconnect cable 8 (gray) to **A11J1 PHASE DET OUT**, cable 93 (white/orange) to **A11J2 M/N IN**, and the cable 5 (green) to **A11J3 20/30 IN**. Reconnect the cable 0 (black) to **A11J4 IF IN** and **A11J5 IF OUT**.
55. Remove the SMA 50 ohm termination from the YTO OUT connector of **A11A1 CIA Assembly**. Install the termination on the RF Section front-panel **1ST LO OUTPUT** connector.
56. Reconnect semi-rigid coax cable **W11** to the YTO OUT connector of **A11A1 CIA Assembly**. Reconnect the opposite end of **W11** to **AT2** (for RF Sections 2526A and below, **W11** connects to cable **A6W6**).
57. Remove the jumper from between **A21TP2** and ground. Remove the jumper between **A12TP2** and **A12TP3 (LOCK INDICATOR DISABLE)**.
58. Replace the RF Section's bottom cover.

17. 20/30 Loop Phase Lock Adjustments

Reference

RF-Section:
A10 20/30 Synthesizer
A10A1 PLL1 VCO
A10A3 PLL1 IF
A10A4 PLL3 Up Converter
A10A5 PLL2 VCO
A10A8 PLL2 Discriminator

Description

Phase Lock Loop 1 (PLL1): On the A10A1 PLL1 VCO Assembly, the Loop Amplifier 40 kHz LPF is first adjusted for >65 dB rejection of the 50 kHz subharmonics from fractional-n division. A frequency synthesizer is used to inject a signal into the 40 kHz LPF, and the filter output is measured with a spectrum analyzer using a high-impedance active probe. Then, the centering and tuning range of the PLL1 VCO is checked and adjusted as required. On the A10A3 PLL1 IF Assembly, the 140 MHz Lowpass Filter is checked and adjusted for maximum rejection of mixing products between 160 MHz and 166 MHz. A synthesized sweeper is substituted for the PLL1 VCO, and the output of the A10A3 PLL1 IF Assembly is measured with a spectrum analyzer.

Phase Lock Loop 2 (PLL2): On the A10A5 PLL2 VCO Assembly and A10A8 PLL2 Discriminator Assembly, four interactive biasing adjustments are used to set the centering and tuning range of the PLL2 VCO. PLL2 VCO biasing is adjusted by setting up proper voltage levels at A10A8TP5 VCO TUNE and adjusting for corresponding PLL2 VCO frequencies at A10A5J4 (SCAN \leq 1 MHz OUT). If PLL2 will not phase lock (PL2 UNLOCK indicated), the A10A6 PLL2 Phase Detector Assembly is first disabled for coarse biasing adjustments. Fine biasing adjustments of the PLL2 VCO are made with the A10A6 PLL2 Phase Detector Assembly installed. Then, span accuracy for narrow spans is checked and adjusted by positioning the 100 MHz CAL OUTPUT signal on the 9th CRT graticule line.

Phase Lock Loop 3 (PLL3): On the A10A4 PLL3 Up Converter Assembly, the 160 MHz BPF is adjusted for maximum output of the 1.6 Frequency Multiplier. The PLL3 VCO biasing is then adjusted by setting up proper voltage levels at A10A4TP3, and the PLL3 VCO output power level is verified.

17. 20/30 Loop Phase Lock Adjustments

Equipment

Spectrum Analyzer	HP 8566B
High-frequency Active Probe	HP 41800A
Probe Power Supply	HP 1122A
Frequency Counter	HP 5343A
Frequency Synthesizer	HP 3335A
Synthesized Sweeper	HP 8340A/B
Precision Power Supply	HP 6114A
Digital Voltmeter	HP 3456A
15x2 Extender Board (<i>service accessory</i>)08505-60041

Adapters:

Adapter, SMB (m)(m)	1250-0672
Adapter, BNC to Alligator Clip	1250-1292

Cables:

BNC to SMB Test Cable (2 required) (*service accessory*) 85680-60093

Procedure

Phase Lock Loop 1 (PLL1)

1. Set the spectrum analyzer LINE switch to STANDBY. Turn the spectrum analyzer over to position the RF Section on top, as shown in Figure 3-77 and remove the RF Section bottom cover.

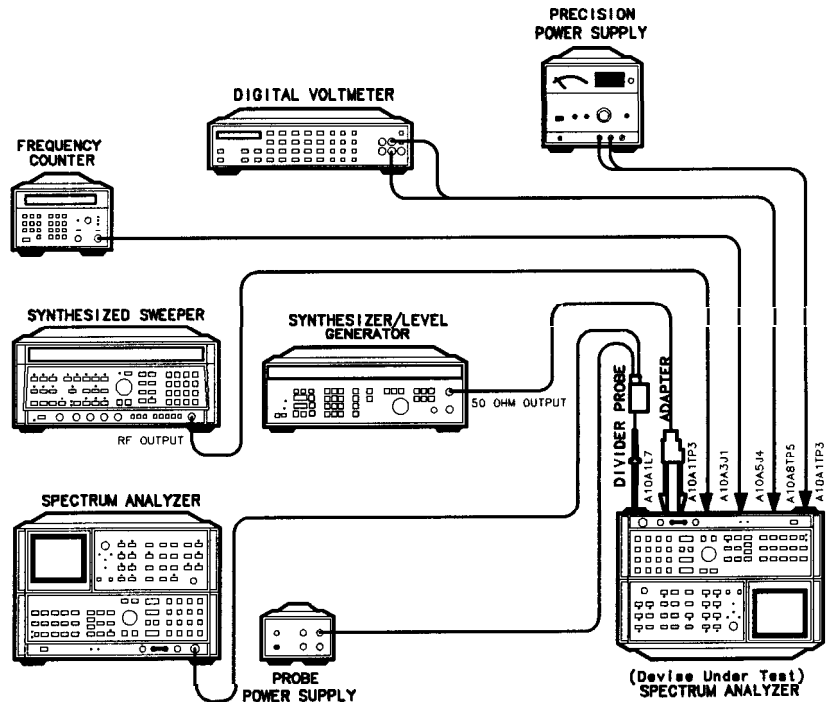

Figure 3-77. 20/30 PLL Adjustment Setup

2. Remove the A10A1PLL1 VCO Assembly from the spectrum analyzer. Disconnect cable 1 (brown) from A10A5J5 SCAN .1-5 MHz OUT, cable 5 (green) from A10A1J2 OUT 20-30 MHz, and the yellow cable from A10A1J3 OUT 200-300 MHz.

17. 20/30 Loop Phase Lock Adjustments

3. Set the frequency synthesizer for a 20 kHz, 0 dBm output.
Connect the frequency synthesizer 50-ohm OUTPUT to A10A1TP3 using a BNC to Alligator clip adapter. Connect the ground lead of the adapter to the metal cover of the A10A1 PLL1 VCO Assembly.
4. Connect the high-frequency active probe to the RF INPUT of the second spectrum analyzer and to the probe power supply, as shown in Figure 3-77.
5. Press **2-22 GHz** on the second spectrum analyzer. Connect the active probe tip to the CAL OUTPUT signal, and press **RECALL**.
6. Adjust the AMPTD CAL control on the second spectrum analyzer for a -10.00 dBm displayed signal, and then press **SHIFT** **FREQUENCY SPAN**^W.
7. Set the controls of the second spectrum analyzer as follows:

CENTER FREQUENCY	35 kHz
FREQUENCY SPAN	50 kHz
REFERENCE LEVEL	0 dBm
LOG SCALE	10 dB/DIV
VIDEO BW	300 Hz
8. Connect the active probe tip to the lead of A10A1L7 closest to A10A1C22, as indicated in Figure 3-78. The 20 kHz signal (from the 40 kHz LPF) should be visible on the display of the second spectrum analyzer.
9. Press **MARKER** **PEAK SEARCH**, **MKR → REF LVL** on the second spectrum analyzer to position the peak of the 20 kHz signal at the top graticule line. Press **MARKER** **la**] on the second spectrum analyzer.
10. Set the frequency synthesizer for an output frequency of 50 kHz.

Note

Adjustments A10A1L7 and A10A1L8 are **sealed** at the factory and normally do not require readjustment unless a component failure has occurred. To verify their proper adjustment, skip to step 12.

11. Adjust A10A1L7 and A10A1L8 50 kHz NULL adjustments to minimize the amplitude of the 50 kHz signal displayed on the second spectrum analyzer. Refer to Figure 3-78 for the location of A10A1L7 and A10A1L8 50 kHz NULL adjustments.

17. 20/30 Loop Phase Lock Adjustments

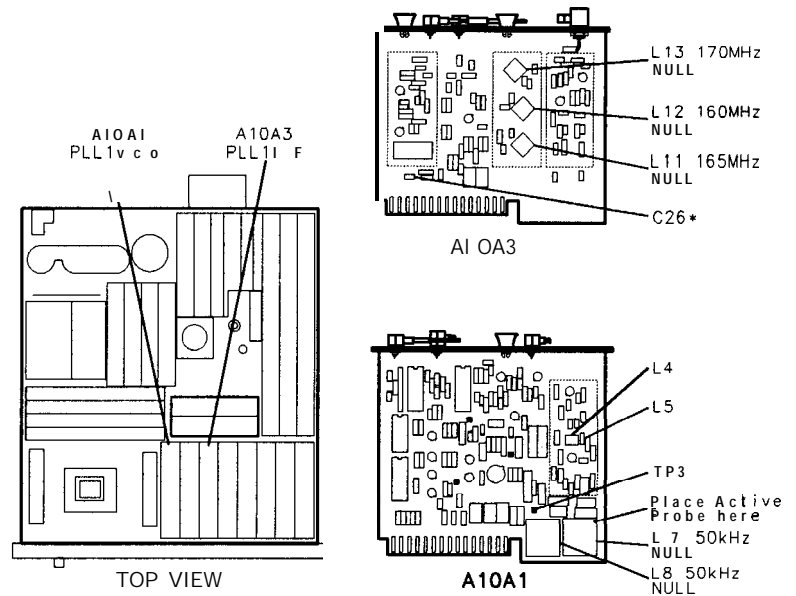

Figure 3-78. Location of PLL1 Adjustments

12. On the second spectrum analyzer, press **CENTER FREQUENCY** 100 MHz **FREQUENCY SPAN** 6 MHz **MARKER** **PEAK SEARCH** to place the second marker on the displayed 50 kHz signal. This level should be at least 65 dB down from the level of the 20 kHz signal in step 9.
13. Disconnect the active probe and frequency synthesizer from A10A1 PLL1 VCO Assembly.
14. Install A10A1 PLL1 VCO Assembly in the RF Section using an extender board. Reconnect the cable 1 (brown) to A10A5J5 SCAN .1-5 MHz OUT and the cable 5 (green) to A10A1J2 OUT 20-30 MHz.
15. Set the RF Section LINE switch to ON, and key in **2-22 GHz**, **FREQUENCY SPAN** 0 HZ.
16. Disconnect the active probe from the RF INPUT of the second spectrum analyzer.
17. Press **2-22 GHz** on the second spectrum analyzer. Connect the CAL OUTPUT signal to the RF INPUT on the second spectrum analyzer, and press **RECALL 8**.
18. Adjust the AMPTD CAL control on the second spectrum analyzer for a -10.00 dBm displayed signal, and then press **SHIFT** **FREQUENCY SPAN**^W.
19. Use a BNC to SMB Snap-on Test Cable to connect the RF INPUT of the second spectrum analyzer to A10A1J3 OUT 200-300 MHz.

17. 20/30 Loop Phase Lock Adjustments

20. Press **2-22 GHz** on the second spectrum analyzer. Set the controls of the second spectrum analyzer as follows:

CENTER FREQUENCY 300 MHz
FREQUENCY SPAN 500 MHz
REFERENCE LEVEL +3 dBm

21. Set the dc power supply for an output of $+ 16.0 \pm 0.1$ Vdc. Connect the positive lead of the dc power supply to **A10A1TP3** and the negative lead to the RF Section chassis (ground).
22. Press **MARKER** **PEAK SEARCH** on the second spectrum analyzer. The output frequency of the **PLL1 VCO** should be $310 \text{ MHz} \pm 10$ MHz as indicated by the marker on the display of the second spectrum analyzer. If it is not, remove the metal shield from **A10A1 PLL1 VCO Assembly** and increase or decrease the spacing between turns of coil **A10A1L4**.

The **PLL1 VCO** frequency is increased by spreading the turns of **A10AIL4** apart (decreasing the inductance), and decreased by compressing the turns of **A10A1L4** together (increasing the inductance). Adjust **A10A1L4** for a **PLL1 VCO** output frequency of approximately 308 MHz, since the metal shield increases the **PLL1 VCO** frequency approximately 2 MHz when reinstalled.

23. Set the dc power supply for an output of $+4.0 \pm 0.1$ Vdc.
24. Press **MARKER** **PEAK SEARCH** on the second spectrum analyzer. The frequency of the **PLL1 VCO** output signal should drop below 200 MHz, and the power level should be at least -7 dBm, as indicated by the marker on the display of the second spectrum analyzer.
25. Repeat steps 21 through 24 as necessary until no further adjustment is required.
26. Set the RF Section **LINE** switch to **STANDBY**. Replace the metal shield on **A10A1 PLL1 VCO Assembly** if it was removed, and reinstall **A10A1 PLL1 VCO Assembly** in the RF Section. Reconnect the cable 1 (brown) to **A10A5J5 SCAN .1-5 MHz OUT** and the cable 5 (green) to **A10A1J2 OUT 20-30 MHz**.
27. Remove **A10A3 PLL1 IF Assembly** from the RF Section, and install it on an extender board. Reconnect the cable 6 (blue) to **A10A4J2 OUT 160-166 MHz**. Leave the cable 4 (yellow) disconnected from **A10A1J3 OUT 200-300 MHz**, and the cable 3 (orange) disconnected from **A10A3J3 OUT PLL1 IF**.
28. Use a BNC to SMB Snap-on Test Cable to connect the **RF INPUT** of the second spectrum analyzer to **A10A3J3 OUT PLL1 IF**

17. 20/30 Loop Phase Lock Adjustments

29. Set the controls of the second spectrum analyzer as follows:

CENTER FREQUENCY 165 MHz
FREQUENCY SPAN 15 MHz
RES BW 30 kHz
REFERENCE LEVEL -7 dBm
LOG SCALE 10 dB/DIV
MARKER OFF

30. Press **INSTR PRESET** on the synthesized sweeper, and key in **CW** 330.3 MHz, **POWER LEVEL** 0 dBm.
31. Use a second BNC to SMB Snap-on Test Cable and an SMB adapter to connect the cable 4 (yellow) from A10A3J1 IN 200-300 MHz to the RF OUTPUT of the synthesized sweeper.
32. Set the RF Section LINE switch to ON, and key in **2-22 GHz**, **CENTER FREQUENCY** 42.57 MHz, **FREQUENCY SPAN** 0 Hz.

Note

Adjustments A10A3L11 165 MHz NULL, A10A3L12 160 MHz NULL, and A10A3L13 170 MHz NULL are sealed at the factory and normally do not require readjustment unless a component failure has occurred. To verify their proper adjustment, skip to step 39.

33. Adjust A10A3L11 165 MHz NULL, A10A3L12 160 MHz NULL, and A10A3L13 170 MHz NULL fully clockwise.
34. Adjust A10A3L13 170 MHz NULL to minimize the amplitude of the 170 MHz signal displayed on the second spectrum analyzer. Refer to Figure 3-78 for the location of A10A3L3 170 MHz NULL adjustment.
35. On the synthesized sweeper, key in **CW** 325.3 MHz.
36. Adjust A10A3L11 165 MHz NULL to minimize the amplitude of the 165 MHz signal displayed on the second spectrum analyzer. Refer to Figure 3-78 for the location of A10A3L11 165 MHz NULL adjustment.
37. On the synthesized sweeper, key in **CW** 320.3 MHz.
38. Adjust A10A3L12 160 MHz NULL to minimize the amplitude of the 160 MHz signal displayed on the second spectrum analyzer. Refer to Figure 3-78 for the location of A10A3L12 160 MHz NULL adjustment.
39. On the synthesized sweeper, key in **CW** 260.3 MHz.
40. On the second spectrum analyzer, press **CENTER FREQUENCY** 100 MHz **FREQUENCY SPAN** 6 MHz **MARKER** **PEAK SEARCH** to position a marker on the peak of the displayed 100 MHz signal, and verify that the output power level of the PLL1 IF is at least -14 dBm.
- If it is not, a lower value can be selected for factory-select component A10A3C26 to improve the impedance match between the double-balanced mixer A10A3U1 and the IF Input Amplifier circuit on A10A3 PLL1 IF Assembly. Refer to Table 3-3 for the acceptable range of values for A10A3C26, and to Table 3-4 for HP part numbers; refer to Figure 3-78 for the location of A10A3C26.
41. On the synthesized sweeper, key in **START FREQ** 300.3 MHz.

17. 20/30 Loop Phase Lock Adjustments

42. On the second spectrum analyzer, press **[CENTER FREQUENCY]** 140 MHz **MARKER [PEAK SEARCH]** to position a marker on the peak of the displayed 140 MHz signal, and verify that the output power level of the PLL1 IF is at least -14 dBm.

If it is not, slightly readjust A10A3L11 165 MHz NULL to increase the amplitude of the 140 MHz signal displayed on the second spectrum analyzer to -14 dBm. Refer to Figure 3-78 for the location of A10A3L11 165 MHz NULL adjustment.

43. Key in **MARKER [PEAK SEARCH], [MKR → REF LVL]** on the second spectrum analyzer to position the peak of the 140 MHz signal at the top graticule line. Press **MARKER [a]** on the second spectrum analyzer.
44. On the synthesized sweeper, key in **[START FREQ]** 320.3 MHz **[STOP FREQ]** 326.3 MHz **[SWEEP TIME]** 100 s **[CW]** 320.3 MHz.
45. Press **[CENTER FREQUENCY]** 163 MHz **TRACE A [MAX HOLD]** on the second spectrum analyzer. Allow the synthesized sweeper to tune slowly from 320.3 MHz to 326.3 MHz, noting the corresponding 160 MHz to 166 MHz signal on the display of the second spectrum analyzer.

Note

The corresponding 160 MHz to 166 MHz signal might be below the displayed noise level on the second spectrum analyzer.

46. On the second spectrum analyzer, press **MARKER [PEAK SEARCH]** to position the second marker on the peak response between 160 MHz and 166 MHz. This level should be at least 60 dB down from the level of the 140 MHz signal in step 42.
47. Set the RF Section LINE switch to STANDBY. Disconnect the second spectrum analyzer from A10A3J3 OUT PLL1 IF, and disconnect the synthesized sweeper from the cable 4 (yellow).
48. Reinstall A10A3 PLL1 IF Assembly in the RF Section. Reconnect the cable 6 (blue) to A10A4J2 OUT 160-166 MHz, the cable 4 (yellow) to A10A1J3 OUT 200-300 MHz, and the cable 3 (orange) to A10A3J3 OUT PLL1 IF.

Phase Lock Loop 2 (PLL2)

Note

If PLL2 is phaselocked, proceed to step 12. If PLL2 will not phaselock (PL2 UNLOCK indicated on CRT), start with step 1.

1. Set the RF Section LINE switch to STANDBY. Remove A10A6 PLL2 Phase Detector Assembly from its connector on the A23 Motherboard Assembly. It is not necessary to completely remove the A10A6 PLL2 0 Detector Assembly from the RF Section.
2. Set the RF Section LINE switch to ON and press **2-22 GHz**.
3. Disconnect the cable 7 (violet) from A10A5J4 SCAN \leq 1 MHz OUT, and connect the frequency counter BNC input to A10A5J4 using a BNC to SMB Snap-on Test Cable. Set the input selector switch on the frequency counter to **10 HZ - 500 MHZ**, and set the impedance switch to **50 Ω** .
4. On the RF Section, key in **STOP FREQ** 10 MHz, **START FREQ** 8.600 MHz, **(SHIFT) MKR \rightarrow REF LVL^R**, SWEEP **(SINGLE)**, TRACE A **(CLEAR-WRITE)**.
5. Connect the DVM to A10A8TP5 VCO TUNE. Refer to Figure 3-79 for the location of A10A8TP5 VCO TUNE.

17. 20/30 Loop Phase Lock Adjustments

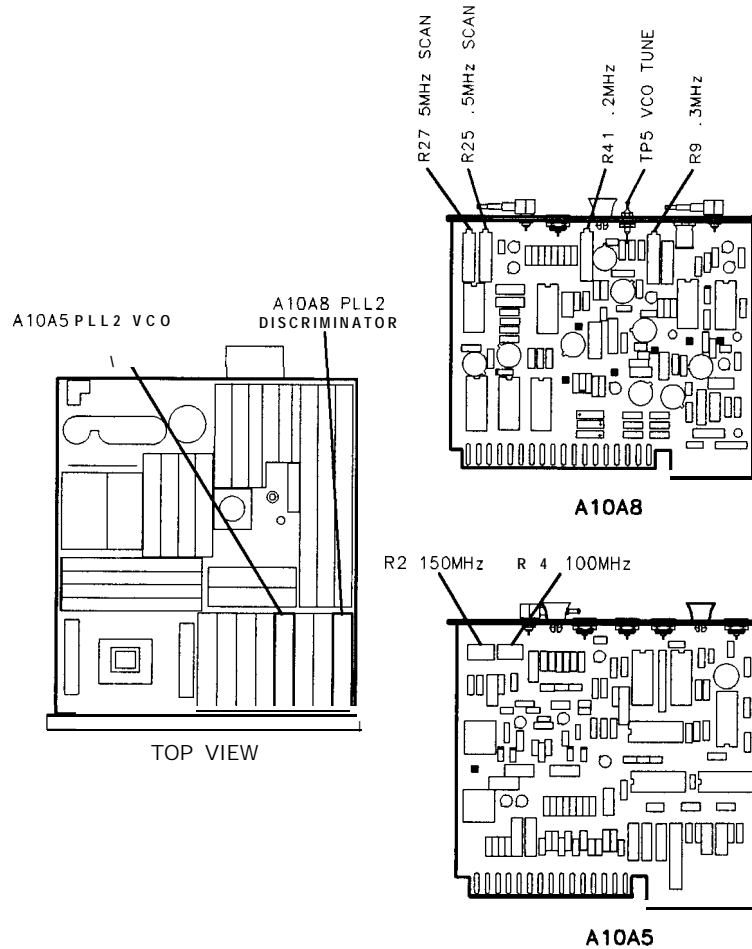

Figure 3-79. Location of PLL2 Adjustments

6. Adjust A10A5R2 150 MHz adjustment for a DVM indication of $+3.0 \pm 0.5$ Vdc. Refer to Figure 3-79 for the location of A10A5R2 150 MHz adjustment.
7. Adjust A10A8R9 .3 MHz adjustment for a frequency counter indication of $0.300 \text{ MHz} \pm 0.001 \text{ MHz}$. Refer to Figure 3-79 for the location of A10A8R9 .3 MHz adjustment.
8. On the RF Section, key in [START FREQ]8.599 MHz, SWEEP [SINGLE], TRACE A [CLEAR-WRITE].

Note

The CRT annotation will round off to 8.59 MHz, but the RF Section is actually set to a start frequency of 8.599 MHz.

9. Adjust A10A5R4 100 MHz adjustment for a DVM indication of $+15.0 \pm 0.5$ Vdc. Refer to Figure 3-79 for the location of A10A5R4 100 MHz adjustment.
10. Adjust A10A8R41 .2 MHz adjustment for a frequency counter indication of $0.200 \pm 0.001 \text{ MHz}$. Refer to Figure 3-79 for the location of A10A8R41 .2 MHz adjustment.

17. 20/30 Loop Phase Lock Adjustments

11. Set the RF Section LINE switch to STANDBY. Disconnect the frequency counter from A10A5J4 SCAN \leq .1 MHz OUT. Reinstall A10A6 PLL2 Phase Detector Assembly in the RF Section and reconnect the cable 7 (violet) to A10A5J4 SCAN \leq .1 MHz OUT.
12. Set the RF Section LINE switch to ON, and key in 2-22 GHz, STOP FREQ 10 MHz, START FREQ 8.600 MHz, SWEEP SINGLE, TRACE A CLEAR-WRITE.
13. Connect the DVM to A10A8TP5 VCO TUNE.
14. Adjust A10A5R2 150 MHz adjustment for a DVM reading of $+3.00 \pm 0.05$ Vdc.
15. Connect the DVM to A10A6TP7 PHASE DET OUT, located on the cover of the A10A6 PLL2 Phase Detector Assembly.
16. Press SWEEP CONT. Adjust A10A8R9 .3 MHz adjustment for a DVM indication of $+3.50 \pm 0.05$ Vdc.
17. On the RF Section, key in START FREQ 8.599 MHz, SWEEP SINGLE, TRACE A CLEAR-WRITE.

Note

The CRT annotation will round off to 8.60 MHz, but the RF Section is actually set to a start frequency of 8.599 MHz.

18. Connect the DVM to A10A8TP5 VCO TUNE.
19. Adjust A10A5R4 100 MHz adjustment for a DVM indication of $+15.00 \pm 0.05$ Vdc.
20. Connect the DVM to A10A6TP7 PHASE DET OUT.
21. Adjust A10A8R41 .2 MHz adjustment for a DVM indication of 3.50 ± 0.05 Vdc.
22. Repeat steps 12 through 21 as necessary until no further adjustment is required.
23. On the RF Section, connect the front-panel CAL OUTPUT signal to the RF INPUT.
24. On the RF Section, key in STOP FREQ 100.5 MHz, START FREQ 95.5 MHz, SWEEP CONT, SWEEP TIME 100 ms.
25. Adjust A10A8R27 5 MHz SCAN to center the 100 MHz CAL OUTPUT signal on the center graticule line. Refer to Figure 3-79 for the location of A10A8R27 5 MHz SCAN adjustment.
26. On the RF Section, key in STOP FREQ 100.05 MHz, START FREQ 99.55 MHz, SWEEP TIME 500 msec.
27. Adjust A10A8R25 .5 MHz SCAN to center the 100 MHz CAL OUTPUT signal on the center graticule line. Refer to Figure 3-79 for the location of A10A8R25 .5 MHz SCAN adjustment.

17. 20/30 Loop Phase Lock Adjustments

Phase Lock Loop 3 (PLL3)

1. Set the RF Section LINE switch to STANDBY. Remove A10A4 PLL3 Up Converter Assembly from the RF Section, and install it on an extender board. Reconnect the cable 7 (violet) to A10A5J4 SCAN \leq .1 MHz OUT and the cable 8 (gray) to A10A4J3 IN 100 MHz.
2. Connect the RF INPUT of the second spectrum analyzer to SMB test connector A10A4J4. Refer to Figure 3-80 for the location of test connector A10A4J4.

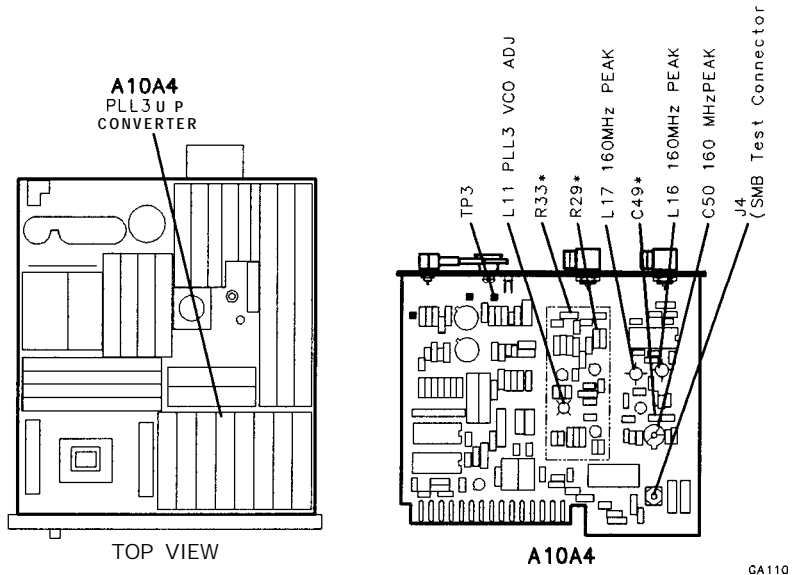

Figure 3-80. Location of PLL3 Adjustments

3. Set the RF Section LINE switch to ON, and key in $\boxed{2-22 \text{ GHz}}$, $\boxed{\text{FREQUENCY SPAN}} \boxed{0} \text{ HZ}$.
4. On the second spectrum analyzer, key in $\boxed{2-22 \text{ GHz}}$, $\boxed{\text{SHIFT}}$ $\boxed{\text{START FREQ}}^X$. Set the controls of the second spectrum analyzer as follows:

CENTER FREQUENCY	160 MHz
FREQUENCY SPAN	200 kHz
RES BW (MANUAL)	10 kHz
REFERENCE LEVEL	-20 dBm

Note

In addition to the displayed 160 MHz signal, other signals should be present at A10A4J4 at approximately 160.3 MHz and 300 kHz.

5. On the second spectrum analyzer, key in $\boxed{\text{MARKER}} \boxed{\text{PEAK SEARCH}}$, $\boxed{\text{MKR}} \rightarrow \boxed{\text{REF LVL}}$ to position the peak of the displayed 160 MHz signal at the top CRT graticule line. Then, key in $\boxed{\text{ENTER dB/DIV}} \boxed{2} \text{ dB}$, $\boxed{\text{FREQUENCY SPAN}} \boxed{50} \text{ kHz}$, $\boxed{\text{REFERENCE LEVEL}} \boxed{\text{STEP}} \boxed{\uparrow} \boxed{\uparrow}$ on the second spectrum analyzer to lower the peak of the displayed signal by three major graticule divisions.

Note

Adjustments A10A4L16 160 MHz PEAK and A10A4L17 160 MHz PEAK are sealed at the factory and normally do not require readjustment unless a component failure has occurred. To verify their proper adjustment, skip to step 7.

6. Adjust A10A4L16 160 MHz PEAK and A10A4L17 160 MHz PEAK to maximize the amplitude of the 160 MHz signal displayed on the second spectrum analyzer. The two adjustments are interactive; repeat the adjustment as necessary to ensure maximum signal amplitude. Refer to Figure 3-80 for the location of A10A4L16 160 MHz PEAK and A10A4L17 160 MHz PEAK adjustments.
7. Adjust A10A4C50 160 MHz PEAK to maximize the amplitude of the 160 MHz signal displayed on the second spectrum analyzer. If after adjustment A10A4C50 is completely open, select a lower value for factory-selected component A10A4C49; conversely, if after adjustment A10A4C50 is completely closed, select a higher value for factory-selected component A10A4C49. Refer to Table 3-12 for the acceptable range of values and corresponding HP part numbers for A10A4C49, and to Figure 3-80 for the location of A10A4C50 160 MHz PEAK and A10A4C49.

Table 3-12. Standard Values for A10A4C49

Value	HP Part Number
10 pF	0160-3874
11 pF	0160-4520
12 pF	0160-4521
13 pF	0160-4522
15 pF	0160-4289

8. On the RF Section, key in CENTER FREQUENCY 42.450 MHz, FREQUENCY SPAN 100 kHz, SWEEP (SINGLE), TRACE A (CLEARWRITE).
9. Set the controls of the second spectrum analyzer as follows:
 - CENTER FREQUENCY 6 MHz
 - FREQUENCY SPAN 1 MHz
 - RES BW (AUTO)
 - REFERENCE LEVEL -30 dBm
 - LOG SCALE 10 dB/DIV
 - MARKER (OFF)
10. On the second spectrum analyzer, press MARKER (PEAK SEARCH) to position the marker on the peak response. If this level is not at least -42 dBm, repeat steps 3 through 10.
11. Disconnect the second spectrum analyzer from SMB test connector A10A4J4. Connect the second spectrum analyzer to A10A4J2 OUT 160 – 166 MHz. Connect the DVM to A10A4TP3. Refer to Figure 3-80 for the location of A10A4TP3.

17. 20/30 Loop Phase Lock Adjustments

12. Set the controls of the second spectrum analyzer as follows:

CENTER FREQUENCY 166 MHz
 FREQUENCY SPAN50 MHz
 REFERENCE LEVEL -14 dBm
 MARKER **NORMAL**

Note

Adjustment **A10A4L11 PLL3 VCO ADJ** is sealed at the factory and normally does not require readjustment unless a component failure has occurred. **A10A4L11 PLL3 VCO ADJ** should be adjusted with the **metal** shield installed over the PLL3 VCO on **A10A4 PLL3 Up Converter Assembly**.

13. A 166 MHz signal should be centered on the display of the second spectrum analyzer, indicating that PLL3 is phaselocked. If not, coarse adjust **A10A4L11 PLL3 VCO ADJ** to center the signal displayed on the second spectrum analyzer and phaselock PLL3.

14. With PLL3 phaselocked, readjust **A10A4L11 PLL3 VCO ADJ** as necessary for a DVM indication of -7.0 ± 0.1 Vdc.

15. On the RF Section, key in CENTER FREQUENCY 42.569999 MHz, FREQUENCY SPAN 0 HZ, SWEEP (SINGLE), TRACE A CLEARWRITE. The DVM indication should be -3.5 ± 0.6 Vdc.

16. On the RF Section, key in CENTER FREQUENCY 42.6499 MHz, FREQUENCY SPAN 100 kHz, SWEEP (SINGLE), TRACE A CLEARWRITE.

17. Set the controls of the second spectrum analyzer as follows:

CENTER FREQUENCY 164.001 MHz
 FREQUENCY SPAN 1 MHz
 REFERENCE LEVEL -14 dBm

18. On the second spectrum analyzer, press MARKER PEAK SEARCH and verify that the output power level of the PLL3 VCO at 164.001 MHz is $-20 \text{ dBm} \pm 2 \text{ dB}$ as indicated by the marker.

If it is not, note the amplitude and change the values of factory-select resistors **A10A4R29** and **A10A4R33** as necessary. Refer to **Table 3-13** for a list of standard resistor values and corresponding change in circuit gain to adjust the PLL3 VCO output power level to -20 dBm , and to **Table 3-4** for HP part numbers.

Table 3-13.
Standard Values for A10A4R29 and A10A4R33

Gain (dB)	Resistors	
	R29	R33
0	68.1	68.1
+0.7	68.1	75
+1.2	75	75
+2.0	68.1	82.5
+3.5	75	90.9

17. 20/30 Loop Phase Lock Adjustments

19. Set the RF Section LINE switch to STANDBY. Disconnect the DVM from A10A4TP3 and the second spectrum analyzer from A10A4J2 OUT 160-166 MHz.
20. Reinstall A10A4 PLL3 Up Converter Assembly in the RF Section. Reconnect the cable 7 (violet) to A10A5J4 SCAN \leq .1 MHz OUT, the cable 6 (blue) to A10A4J2 OUT 160-166 MHz, and the cable 8 (gray) to A10A4J3 IN 100 MHz.

18. RF Module Phase Lock Adjustments

Reference RF-Section:
A6A9 Phase Lock

Description The 3.3 GHz Heterodyne Phase Lock Loop sampler circuits and 300 MHz Tripler circuits on the A6A9 Phase Lock Assembly are adjusted and checked for proper operation. The match between the Sampler Driver circuit and the A6A9U1 Sampler is adjusted. Then, the output balance of the A6A9U1 Sampler is set. A second spectrum analyzer is used to adjust the output match between the Tripler circuit and the 300 MHz Power Amplifier. Tripler match is adjusted for maximum 300 MHz output signal with all harmonics more than 15 dB down.

Equipment Spectrum Analyzer HP 8566B
Digitizing Oscilloscope HP 54501A
Digital Voltmeter HP 3456A
15x2 Extender Board (*service* accessory) 08505-60041
BNC 50-ohm Termination HP 11593A

Cables:

BNC to SMB Cable (*service* accessory) 85680-60093

- Procedure**
1. Set the spectrum analyzer LINE switch to STANDBY. Turn the spectrum analyzer over to position the RF Section on top, as shown in Figure 3-81, and remove the RF Section bottom cover.
 2. In the RF Section, disconnect the cable 84 gray/yellow from A6A12J1 and the cable 82 (gray/red) from A6A12J2. Remove the cover from the A6 RF Module, and then reconnect the cable 84 (gray/yellow) to A6A12J1 and the cable 82 (gray/red) to A6A12J2. Refer to Figure 3-82 for the location of the A6A12 YTX Driver Assembly and the A6 RF Module.

Sampler Match and HET Unlock Detector Delay Adjustments

Caution

A6A9U1 Sampler is very susceptible to damage from electrostatic discharge (ESD). Be sure to use proper grounding techniques when handling A6A9 Phase Lock assembly and when disconnecting and connecting cables to A6A9J5 3.3 GHz INPUT and test points A6A9A1E5 and A6A9A1E6.

18. RF Module Phase Lock Adjustments

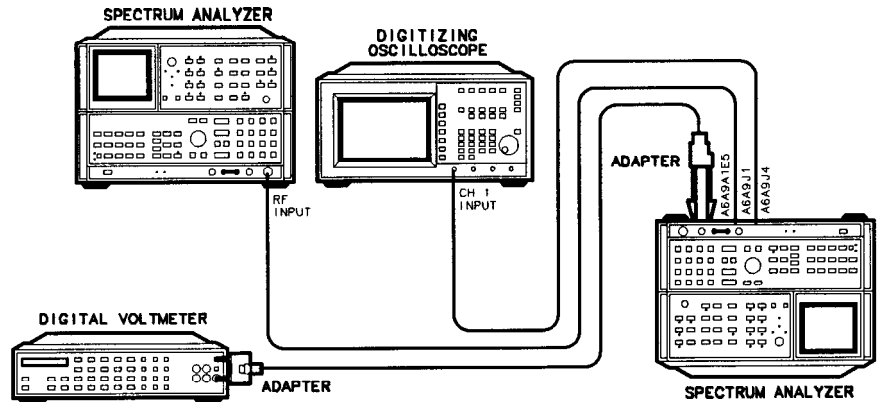

Figure 3-81. RF Module Phase Lock Adjustments Setup

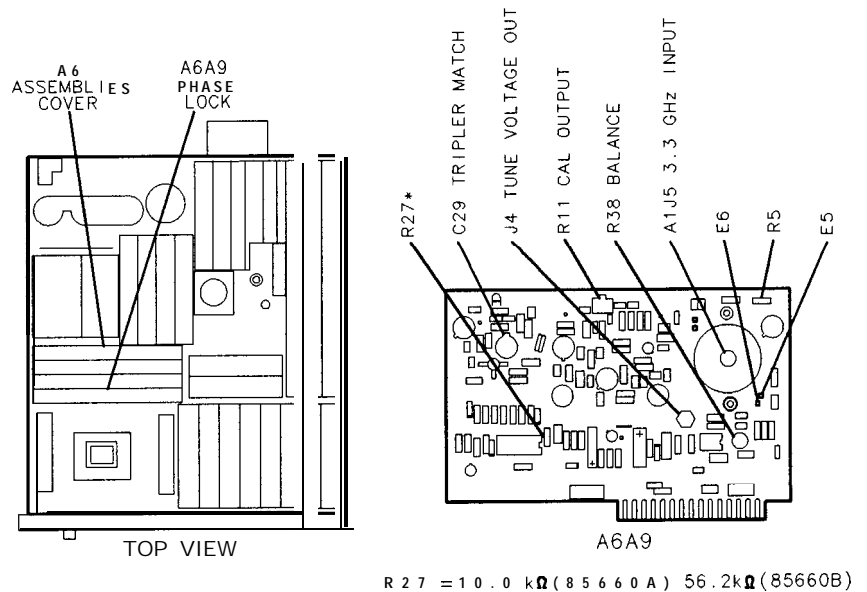

Figure 3-82. Location of RF Module Phase Lock Adjustments

3. Disconnect the cable 2 (red) from A6A9J1 300 MHz OUTPUT, the cable 0 (black) from A6A9J2 CAL OUTPUT, the cable 85 (gray/green) from A6A9J3 100 MHz INPUT, the cable 4 (yellow) from A6A9J4 VCO TUNE, and the cable 5 (green) from A6A9J5 3.3 GHz INPUT. Remove the A6A9 Phase Lock Assembly from the RF Section.
4. Remove the front cover from the A6A9 Phase Lock Assembly, and install it in the RF Section on an extender board. Reconnect the cable 85 (gray/green) to A6A9J3 100 MHz INPUT, the cable 4 (yellow) to A6A9J4 VCO TUNE, and cable 5 (green) to A6A9J5 3.3 GHz INPUT.
5. Set the spectrum analyzer LINE switch to ON, and press **0-2.5 GHz**.

18. RF Module Phase Lock Adjustments

6. Connect the DVM to A6A9A1E5, and connect the DVM ground to the metal case/shield of the A6A9 Phase Lock Assembly. Refer to Figure 3-82 for the location of A6A9A1E5 and A6A9A1E6.

7. Note the DVM indication at A6A9A1E5.

Voltage at A6A9A1E5: _____Vdc

8. Connect the DVM to A6A9A1E6, and note the DVM indication.

Voltage at A6A9A1E6: _____Vdc

9. Add the voltage measured in step 7 to the voltage measured in step 8. The absolute value of the resulting sum should be less than 0.20 Vdc. If the resulting sum is greater than 0.20 Vdc, suspect a failure of A6A9U1 Sampler or related circuit components.

Note

The voltage at A6A9A1E5 should fall in the range of -0.55 Vdc and -0.85 Vdc, and the voltage at A6A9A1E6 should fall in the range of 0.55 Vdc to 0.85 Vdc. If either of the voltages at A6A9A1E5 and A6A9A1E6 do not fall within these ranges, change the value of factory-select component A6A9A1R5. Decreasing the value of A6A9A1R5 decreases the magnitude of the voltages at both A6A9A1E5 and A6A9A1E6. Conversely, an increasing the value of A6A9A1R5 increases the magnitude of the voltages at both A6A9A1E5 and A6A9A1E6. Refer to Table 3-3 for the acceptable range of values for A6A9A1R5, and to Table 3-4 for HP part numbers. Refer to Figure 3-82 for the location of A6A9A1R5.

For example, if the voltage measured at A6A9A1E5 is -0.87 Vdc and the voltage measured at A6A9A1E6 is 0.86 Vdc, then the absolute value of the resulting sum is $-0.87 + 0.86 = 0.01$ Vdc. Since the resulting sum is less than 0.20 Vdc, the A6A9U1 Sampler is probably not faulty. For this example, the value of A6A9A1R5 should be reduced to decrease the magnitude of both measured voltages to within the recommended ranges. The magnitudes of the voltages measured at A6A9A1E5 and A6A9A1E6 are:

Voltage at A6A9A1E5 = $-0.87 = 0.87$ Vdc

Voltage at A6A9A1E6 = $0.86 = 0.86$ Vdc

10. Verify that the loaded value of factory-select resistor A6A9A1R27 is 56.2K ohms. Refer to Figure 3-82 for the location of A6A9A1R27.

Note

Factory-select resistor A6A9A1R27 must be loaded with a value of 56.2K ohms for proper operation of the HET UNLOCK Detector circuit in HP 85660B RF Sections (A6A9 Phase Lock Assembly HP Part Number 85660-60226 and 85660-60256). A6A9A1R27 must be loaded with a value of 10K ohms for use in HP 85660A RF Sections.

11. Set the spectrum analyzer LINE switch to STANDBY.

18. RF' Module Phase Lock Adjustments

100 MHz Tripler Adjustments

12. Disconnect cable 85 (gray/green) from **A6A9J3** 100 MHz INPUT, cable 4 (yellow) from **A6A9J4** VCO TUNE, and cable 5 (green) from **A6A9J5** 3.3 GHz INPUT. Remove the **A6A9** Phase Lock Assembly from the extender board in the RF Section, and replace the **A6A9** Phase Lock Assembly front cover.
13. Install the **A6A9** Phase Lock Assembly in the RF Section on an extender board. Reconnect cable 0 (black) to **A6A9J2** CAL OUTPUT, cable 85 (gray/green) to **A6A9J3** 100 MHz INPUT, cable 4 (yellow) to **A6A9J4** VCO TUNE, and cable 5 (green) to **A6A9J5** 3.3 GHz INPUT.
14. Set the spectrum analyzer LINE switch to ON and press **0-2.5 GHz**. Connect a 50-ohm termination to the RF Section front-panel CAL OUTPUT connector.
15. Press **2-22 GHz** on the second spectrum analyzer. Connect the CAL OUTPUT signal on the second spectrum analyzer to the RF INPUT on the second spectrum analyzer, and press **RECALL** 8.
16. Adjust the AMPTD CAL control on the second spectrum analyzer for a -10.00 dBm displayed signal, and then press **SHIFT** **FREQUENCY SPAN**^W.
17. Connect the RF INPUT of the second spectrum analyzer to the RF Section **A6A9J1** 300 MHz OUTPUT. Set the controls of the second spectrum analyzer as follows:

CENTER FREQUENCY	550 MHz
FREQUENCY SPAN	1 GHz
REFERENCE LEVEL	+ 25 dBm
ATTEN	40 dB
LOG dB/DIV	10 dB
18. The 300 MHz output signal should be visible on the display of the second spectrum analyzer, along with other harmonics of 100 MHz. Press **MARKER** **PEAK SEARCH** to position a marker on the peak of the displayed 300 MHz signal. Adjust **A6A9A1C29** TRIPLER MATCH to maximize the power level of the 300 MHz signal.
19. Press **MARKER** **PEAK SEARCH** and verify that the power level of the 300 MHz signal is greater than + 16.5 dBm. Press **MARKER** **Δ**, and then press the **↑** and **↓** keys (or turn the DATA knob) to position the second marker on the peak of each of the other displayed harmonics in succession, and verify that the level of each harmonic is greater than 15 dB down relative to the peak of the 300 MHz signal.
20. Disconnect the second spectrum analyzer from the RF Section **A6A9J1** 300 MHz OUTPUT. Remove the 50-ohm termination from the RF Section front-panel CAL OUTPUT connector.

18. RF Module Phase Lock Adjustments

Sampler Output Balance Adjustment

21. Use a BNC to SMB snap-on test cable to connect the oscilloscope Channel 1 input to the RF Section A6A9J4 VCO TUNE connector.
22. On the oscilloscope, key in **(RECALL)****(CLEAR)** to perform a soft reset.
23. Set the oscilloscope controls as follows:

Press **(CHAN)**:

Channel 1 on
 amplitude scale 10.0V/div
 offset -10.0000V
 coupling dc

Press **(TIME BASE)**:

time scale 1msec/div
 reference left

Press (TRIG):

EDGE TRIGGER auto, edge
 source 1
 level -10.0000V, rising edge

Press **(DISPLAY)**:

connect dots on

24. On the oscilloscope press **(SHOW)**. The VCO TUNE waveform displayed on the oscilloscope should be similar to Figure 3-83. Use the oscilloscope **(Δ T Δ V)** markers to measure the waveform maximum and minimum voltages, and the dead time between consecutive voltage ramps.

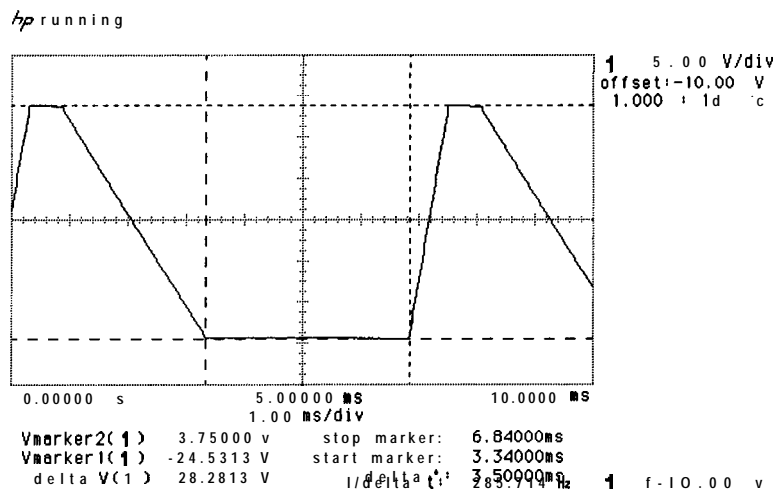

Figure 3-83. A Sampler Balance Adjustment Waveform

18. RF' Module Phase Lock Adjustments

25. Adjust **A6A9A1R38** BALANCE for a dead time between consecutive voltage ramps of 3.5 ± 0.1 msec. Each voltage ramp should have a “flattened” top and reach a maximum voltage of approximately +3.7 Vdc. The minimum voltage between consecutive voltage ramps should be approximately -24.4 Vdc.
26. Set the spectrum analyzer LINE switch to STANDBY. Disconnect the oscilloscope from the RF Section **A6A9J4** VCO TUNE. Disconnect cable 0 (black) from **A6A9J2** CAL OUTPUT, the cable 85 (gray/green) from **A6A9J3** 100 MHz INPUT, and cable 5 (green) from **A6A9J5** 3.3 GHz INPUT.
27. Remove the **A6A9** Phase Lock Assembly from the extender board, and remove the extender board from the RF Section. Reinstall the **A6A9** Phase Lock Assembly in the RF Section.
28. Disconnect cable 84 (gray/yellow) from **A6A12J1** and the cable 82 (gray/red) from **A6A12J2**. Replace the cover to the A6 RF Module, and then reconnect cable 84 (gray/yellow) to **A6A12J1** and cable 82 (gray/red) to **A6A12J2**.
29. Reconnect cable 2 (red) to **A6A9J1** 300 MHz OUTPUT, cable 0 (black) to **A6A9J2** CAL OUTPUT, cable 85 (gray/green) to **A6A9J3** 100 MHz INPUT, cable 4 (yellow) to **A6A9J4** VCO TUNE, and cable 5 (green) to **A6A9J5** 3.3 GHz INPUT on the **A6A9** Phase Lock Assembly.
30. Perform adjustment procedure 19, “CAL Output Adjustment”.

19. CAL Output Adjustment

Reference , RF-Section:
A6A9 Phase Lock
 Related Performance Test:
 Calibrator Amplitude Accuracy Test

Description A power meter is used to measure the output level of the 100 MHz CAL OUTPUT signal. The 100 MHz Calibrator circuit on the A6A9 Phase Lock Assembly is adjusted as necessary for a -10.00 dBm output level. The harmonic level of the calibrator output signal is then checked using a second spectrum analyzer.

Equipment Power Meter HP 436A
 Power Sensor HP 8481A
 Spectrum Analyzer HP 8566B

Procedure 1. Set the spectrum analyzer LINE switch to STANDBY. Position the spectrum analyzer on its right side as shown in Figure 3-84, and remove the RF Section bottom cover.

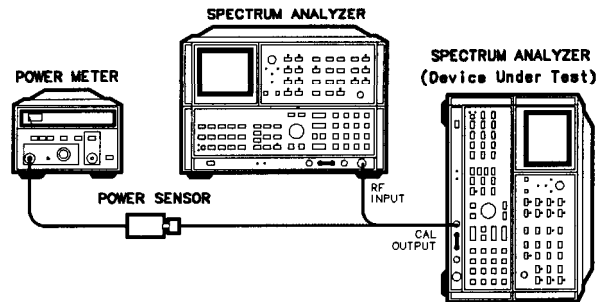

Figure 3-84. Cal Output Adjustment Setup

2. Set the RF Section LINE switch to ON, and allow the RF Section and power meter/power sensor to warm up for at least 5 minutes.
3. Connect the power sensor to the power meter POWER REF output, and zero and calibrate the power meter. Connect the power meter/power sensor to the RF Section front-panel CAL OUTPUT connector.
4. Adjust A6A9A1R11 CAL OUTPUT fully clockwise for maximum circuit gain and verify that the power meter indication is -9.0 dBm or greater. Adjust A6A9A1R11 CAL OUTPUT fully counterclockwise for minimum circuit gain and verify that the power meter indication is - 11 .0 dBm or less.

19. CAL Output Adjustment

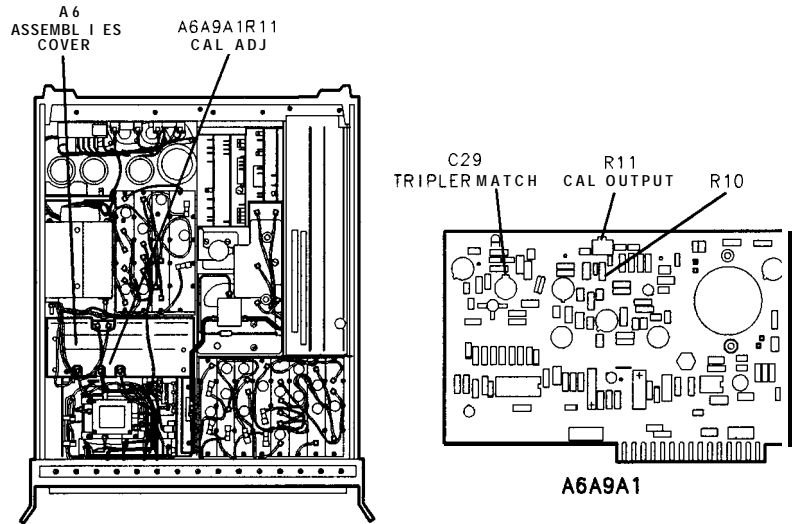

Figure 3-85. Location of CAL OUTPUT Adjustment

Note

A6A9A1R11 CAL OUTPUT should have at least 2.0 dB of adjustment range, centered at a front-panel CAL OUTPUT signal level of -10.0 dBm. If A6A9A1R11 CAL OUTPUT does not have sufficient range to adjust the CAL OUTPUT signal level to -9.0 dBm, decrease the value of factory-select component A6A9A1R10; conversely, increase the value of A6A9A1R10 if A6A9A1R11 CAL OUTPUT does not have sufficient range to adjust the CAL OUTPUT signal level to -11.0 dBm. Select the value of factoryselect component A6A9A1R10 to center the range of A6A9A1R11 CAL OUTPUT as close as possible to the range of -9.0 dBm to -11.0 dBm. Refer to Table 3-3 for the acceptable range of values for A6A9A1R10, and Table 3-4 for HP part numbers. Refer to Figure 3-85 for the location of A6A9A1R10.

5. Adjust A6A9A1R11 CAL OUTPUT for a power meter indication of -10.00 ± 0.01 dBm.
6. Disconnect the power meter/power sensor from the RF Section front-panel CAL OUTPUT connector.
7. Press **2-22 GHz** on the second spectrum analyzer. Connect the CAL OUTPUT signal on the second spectrum analyzer to the RF INPUT on the second spectrum analyzer, and press **RECALL** 8.
8. Adjust the AMPTD CAL control on the second spectrum analyzer for a -10.00 dBm displayed signal, and then press **SHIFT** **FREQUENCY SPAN**^W.
9. Connect the second spectrum analyzer RF input to the RF Section front-panel CAL OUTPUT connector. Set the controls of the second spectrum analyzer as follows:

CENTER FREQUENCY	550 MHz
FREQUENCY SPAN	1 GHz
REFERENCE LEVEL	-7 dBm
LOG dB/DIV	10 dB

19. CAL Output Adjustment

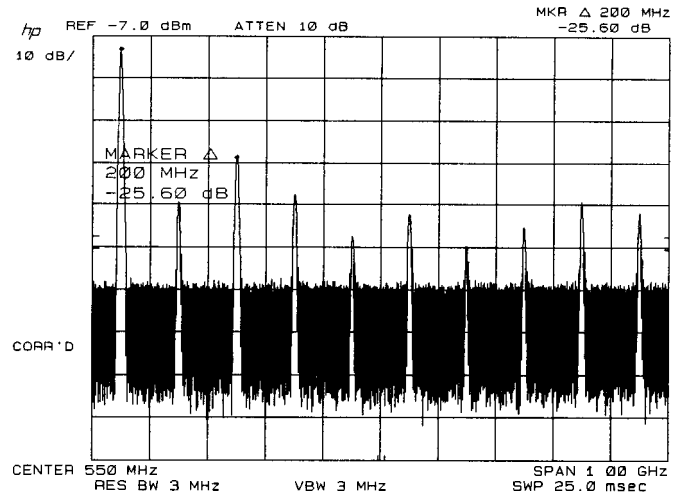

Figure 3-86. CAL OUTPUT Harmonics

10. On the second spectrum analyzer, press **MARKER** [PEAK SEARCH], [al] to position a marker on the peak of the displayed 100 MHz signal. Then, press the **⇧** key (or turn the DATA knob) to position the second marker on the peak of each displayed harmonic of the 100 MHz signal in succession, and verify that the level of each harmonic is greater than 25 dB down relative to the peak of the 100 MHz CAL OUTPUT signal. See Figure 3-86.
If the level of each harmonic of the 100 MHz CAL OUTPUT is not greater than 25 dB down perform the following steps:
 - a. On the second spectrum analyzer, press the **⇧** and **⇩** keys to place the second marker on the peak of the highest harmonic of the 100 MHz signal.
 - b. Adjust **A6A9A1C29 TRIPLER MATCH** only as much as required to lower the level of the highest harmonic to greater than 25 dB down relative to the peak of the 100 MHz CAL OUTPUT signal. Refer to Figure 3-85 for the location of **A6A9A1C29 TRIPLER MATCH**.
 - c. Disconnect cable 2 (red) from **A6A9J1 300 MHz OUTPUT** on the **A6A9 Phase Lock Assembly**. Connect the RF INPUT of the second spectrum analyzer to **A6A9J1 300 MHz OUTPUT**.
 - d. On the second spectrum analyzer, key in [REFERENCE LEVEL] + 25 dBm, **[ATTEN] 40 dB**, **MARKER [OFF]**, **MARKER [PEAK SEARCH]** to position a marker on the peak of the displayed 300 MHz signal. Readjust **A6A9A1C29 TRIPLER MATCH** as necessary for a 300 MHz signal level of at least + 16.5 dBm.
 - e. Disconnect the second spectrum analyzer from **A6A9J1 300 MHz OUTPUT**, and reconnect cable 2 (red) to **A6A9J1 300 MHz OUTPUT**.
 - f. Repeat steps 9 through 10E until no further adjustment is required.
11. Replace the RF Section bottom cover.

20. Last Converter Adjustments

Reference	RF-Section: A6A3 Last Converter								
Description	A 321.4 MHz signal from a synthesized sweeper is applied to the 321.4 MHz IF input of the A6A3 Last Converter Assembly, and the 321.4 MHz Bandpass Filter is adjusted. Then, a 310.7 MHz signal is applied to the 321.4 MHz IF input, and the 10.7 MHz Notch Filter is adjusted to null 10.7 MHz subharmonic spurious responses.								
Equipment	<table border="0"> <tr> <td>Synthesized Sweeper</td> <td>HP 8340A/B</td> </tr> <tr> <td>Spectrum Analyzer</td> <td>HP 8566B</td> </tr> <tr> <td>15x2 Extender Board (service <i>accessory</i>)</td> <td>08505-60041</td> </tr> <tr> <td>Probe (SMB Male Bulkhead Connector)</td> <td>1250-0691</td> </tr> </table> <p>Cables: BNC to SMB Cable (2 required) (<i>service accessory</i>) 85680-60093</p>	Synthesized Sweeper	HP 8340A/B	Spectrum Analyzer	HP 8566B	15x2 Extender Board (service <i>accessory</i>)	08505-60041	Probe (SMB Male Bulkhead Connector)	1250-0691
Synthesized Sweeper	HP 8340A/B								
Spectrum Analyzer	HP 8566B								
15x2 Extender Board (service <i>accessory</i>)	08505-60041								
Probe (SMB Male Bulkhead Connector)	1250-0691								
Procedure	<ol style="list-style-type: none"> 1. Set the spectrum analyzer LINE switch to STANDBY. Turn the spectrum analyzer over to position the RF Section on top, as shown in Figure 3-87, and remove the RF Section bottom cover. 2. In the RF Section, disconnect cable 84 (gray/yellow) from A6A12J1 and cable 82 (gray/red) from A6A12J2. Disconnect cable 2 (red) from A6A9J1 300 MHz OUTPUT, cable 0 (black) from A6A9J2 CAL OUTPUT, cable 85 (gray/green) from A6A9J3 100 MHz INPUT, cable 4 (yellow) from A6A9J4 VCO TUNE, and cable 5 (green) from A6A9J5 3.3 GHz INPUT. 3. Remove the cover from the A6 RF Module. Remove the A6A9 Phase Lock Assembly, the A6A10 Miscellaneous Bias/Relay Driver Assembly, the A6A11 Slope Generator Assembly, and the A6A12 YTX Driver Assembly from the RF Section. 								

20. Last Converter Adjustments

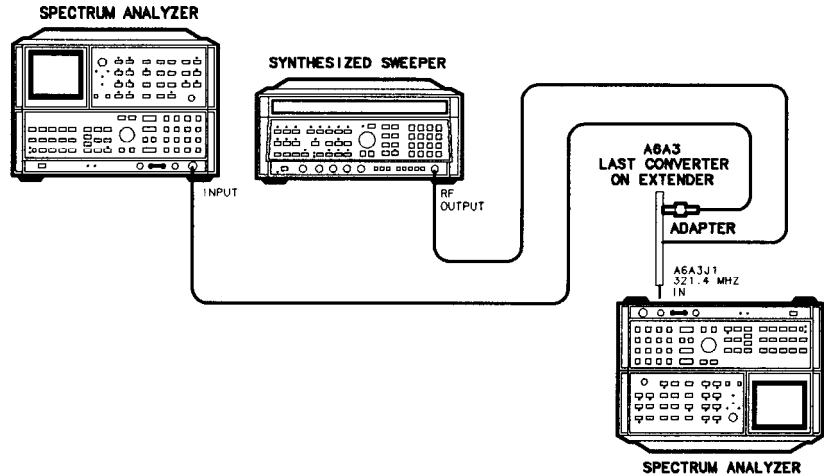

Figure 3-87. Last Converter Adjustments Setup

4. Remove the RF Section right side cover (now on the left), and remove the two screws attaching the A6A3 Last Converter Assembly to the RF Section chassis.
5. Disconnect cable 1 (brown) from A6A3J1 321.4 MHz IN, cable 2 (red) from A6A3J2 300 MHz IN, and cable 81 (gray/brown) from A6A3J3 (21.4 MHz OUT) on the A6A3 Last Converter Assembly. Remove the A6A3 Last Converter Assembly from the RF Section.
6. Adjust the five variable capacitors A6A3A1C8, A6A3A1C9, A6A3A1C10, A6A3A1C11, and A6A3A1C12 in the 321.4 MHz Bandpass Filter for maximum capacitance. The capacitors are visible through five evenly-spaced, unlabeled access holes in the bottom cover of the A6A3 Last Converter Assembly; position each capacitor with its adjustment slot vertical and plates fully meshed. Refer to Figure 3-88 for the location of A6A3A1C8, A6A3A1C9, A6A3A1C10, A6A3A1C11, and A6A3A1C12.
7. Install the A6A3 Last Converter Assembly in the RF Section using an extender board. Reconnect cable 2 (red) to A6A3J2 300 MHz IN.
8. Reinstall the A6A9 Phase Lock Assembly, the A6A10 Miscellaneous Bias/Relay Driver Assembly, the A6A11 Slope Generator Assembly, and the A6A12 YTX Driver Assembly in the RF Section.
9. Reconnect cable 2 (red) to A6A9J1 300 MHz OUTPUT and cable 85 (gray/green) to A6A9J3 100 MHz INPUT.

20. Last Converter Adjustments

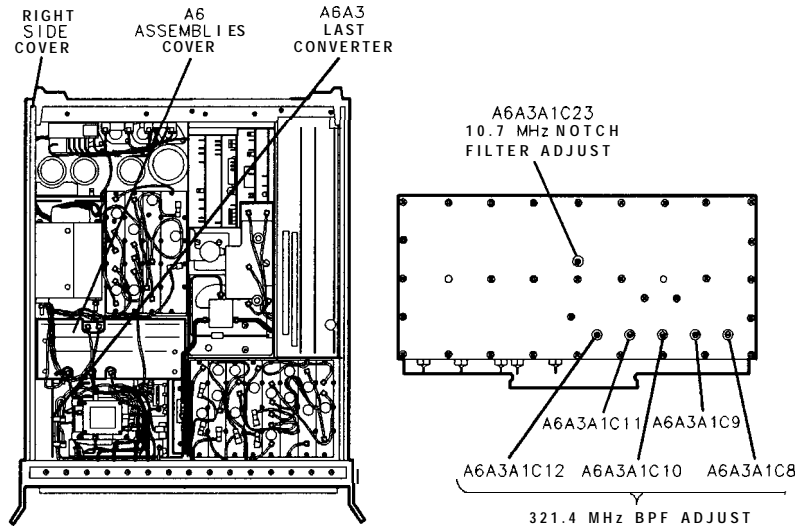

Figure 3-88. Location of Last Converter Adjustments

10. Set the spectrum analyzer LINE switch to ON, and key in **0 - 2.5 GHz**, SWEEP **(SINGLE)**. A HET UNLOCK message should appear on the CRT display.
11. Connect a BNC to SMB snap-on test cable and probe (SMB male bulkhead connector) to the RF INPUT of the second spectrum analyzer.
12. Press **2-22 GHz** on the second spectrum analyzer. Set the controls of the second spectrum analyzer as follows:

CENTER FREQUENCY	321.4 MHz
FREQUENCY SPAN	500 kHz
REFERENCE LEVEL	-30 dBm
13. Press **2-22 GHz** on the synthesized sweeper, and key in **(CW) 321.4 MHz**, **(POWER LEVEL) -20.0 dBm**. Connect the RF OUTPUT of the synthesized sweeper to A6A3J1 321.4 MHz IN using a second BNC to SMB snap-on test cable.

Note

In the following steps, an SMB male bulkhead connector is used as an input probe for the second spectrum analyzer. The probe tip is partially inserted through access holes in the bottom cover of the A6A3 Last Converter Assembly. If the probe tip is allowed to touch one of the adjustable capacitors, false readings will result as indicated by a sudden jump in the amplitude of the 321.4 MHz signal displayed on the second spectrum analyzer.

14. Partially insert the probe connected to the second spectrum analyzer into the access hole above A6A3A1C9 (the second access hole from the right). Using a non-metallic adjustment tool, adjust A6A3A1C8 (the right-most of the five access holes) to maximize the amplitude of the 321.4 MHz signal displayed on the second spectrum analyzer.

20. Last Converter Adjustments

15. Move the probe to the access hole above **A6A3A1C8** (the rightmost access hole). Adjust **A6A3A1C9** (second access hole from the right) to minimize the amplitude of the 321.4 MHz signal displayed on the second spectrum analyzer.
16. With the probe still in the access hole above **A6A3A1C8**, adjust **A6A3A1C10** (center access hole) to maximize the amplitude of the 321.4 MHz signal displayed on the second spectrum analyzer.
17. Adjust **A6A3A1C11** (second access hole from the left) to minimize the amplitude of the 321.4 MHz signal displayed on the second spectrum analyzer.
18. Adjust **A6A3A1C12** (left-most of the five access holes) to maximize the amplitude of the 321.4 MHz signal displayed on the second spectrum analyzer.
19. Remove the probe from the access hole above **A6A3A1C8**, and disconnect the probe from the BNC to SMB snap-on test cable. Use the BNC to SMB snap-on test cable to connect the RF INPUT of the second spectrum analyzer to **A6A3J3** (21.4 MHz OUT).
20. Set the spectrum analyzer controls as follows:

CENTER FREQUENCY	10.7 MHz
FREQUENCY SPAN	500 kHz
REFERENCE LEVEL	-30 dBm
21. On the synthesized sweeper, key in **CW** 310.7 MHz, POWER LEVEL -40 dBm.
22. Locate the 10.7 MHz Notch Filter adjustment, visible through the remaining unlabeled access hole near the center of the bottom cover of the **A6A3** Last Converter Assembly (refer to Figure 3-88). Adjust **A6A3A1C23** to minimize the amplitude of the 10.7 MHz signal displayed on the second spectrum analyzer.
23. Set the RF Section LINE switch to STANDBY.
24. Disconnect the synthesized sweeper from **A6A3J1** 321.4 MHz IN. Disconnect the second spectrum analyzer from **A6A3J3** (21.4 MHz OUT).

Disconnect cable 2 (red) from **A6A3J2** 300 MHz IN.
25. Disconnect cable 2 (red) from **A6A9J1** 300 MHz OUTPUT and cable 85 (gray/green) from **A6A9J3** 100 MHz INPUT. Remove the **A6A9** Phase Lock Assembly, the **A6A10** Miscellaneous Bias/Relay Driver Assembly, the **A6A11** Slope Generator Assembly, and the **A6A12** YTX Driver Assembly from the RF Section.
26. Reinstall the **A6A3** Last Converter Assembly in the RF Section, and replace the two screws attaching the **A6A3** Last Converter Assembly to the RF Section chassis. Replace the RF Section right side cover.
27. Reconnect cable 1 (brown) to **A6A3J1** 321.4 MHz IN, cable 2 (red) to **A6A3J2** 300 MHz IN, and cable 81 (gray/brown) to **A6A3J3** (21.4 MHz OUT) on the **A6A3** Last Converter Assembly.
28. Reinstall the **A6A9** Phase Lock Assembly, the **A6A10** Miscellaneous Bias/Relay Driver Assembly, the **A6A11** Slope

20. Last Converter Adjustments

Generator Assembly, and the **A6A12** YTX Driver Assembly in the RF Section. Replace the cover on the A6 RF Module.

29. Reconnect cable 84 (gray/yellow) to **A6A12J1** and cable 82 (gray/red) to **A6A12J2**. Reconnect cable 2 (red) to **A6A9J1** 300 MHz OUTPUT, cable 0 (black) to **A6A9J2** CAL OUTPUT, cable 85 (gray/green) to **A6A9J3** 100 MHz INPUT, cable 4 (yellow) to **A6A9J4** VCO TUNE, and cable 5 (green) to **A6A9J5** 3.3 GHz INPUT.
30. Replace the RF Section bottom cover.

2 1. Frequency Response Adjustments

Reference RF Section:
 A6A3 Last Converter
 A6A10 Miscellaneous Bias/Relay Driver
 A6A11 Slope Generator
 A6A12 YTX Driver

Related Performance Test Frequency Response Test
 Sweep + Tune Output Test

Description The frequency response (flatness) and amplitude adjustments are performed for each of the spectrum analyzer frequency bands listed in Table 3-14.

Table 3-14. Frequency Bands

Bands	Harmonic Mixing Number/Mode	Frequency Range	IF Frequency
0 Band A	1–	100 Hz – 2.5 GHz	3.6214 GHz
Preselected Mixing Bands:			
1 Band B	1–	2.0 GHz – 5.8 GHz	0.3214 GHz
2 Band C	2+	5.8 GHz – 12.5 GHz	0.3214 GHz
3 Band D	3+	12.5 GHz – 18.6 GHz	0.3214 GHz
4 Band E	4+	18.6 GHz – 22.0 GHz	0.3214 GHz
External Mixing Bands (Band F; nominal conversion losses listed):			
6 (K)	6+	18.6 GHz – 26.5 GHz	0.3214 GHz 18 dB
7 (A)	8+	26.5 GHz – 40.0 GHz	0.3214 GHz 20 dB
8 (Q)	10+	33.0 GHz – 50.0 GHz	0.3214 GHz 22 dB
9 (U)	10+	40.0 GHz – 60.0 GHz	0.3214 GHz 24 dB
10 (V)	14+	50.0 GHz – 75.0 GHz	0.3214 GHz 26 dB
11 (E)	16+	60.0 GHz – 90.0 GHz	0.3214 GHz 28 dB
12 (W)	18+	75.0 GHz – 110 GHz	0.3214 GHz 30 dB
13 (F)	24+	90.0 GHz – 140 GHz	0.3214 GHz 32 dB
14 (D)	30+	110 GHz – 170 GHz	0.3214 GHz 34 dB
15 (G)	36+	140 GHz – 210 GHz	0.3214 GHz 36 dB
16 (Y)	44+	170 GHz – 260 GHz	0.3214 GHz 38 dB
17 (J)	54+	170 GHz – 325 GHz	0.3214 GHz 40 dB

In Band A (100 Hz – 2.5 GHz), the A6A6 First Converter Assembly functions as the spectrum analyzer input mixer. In Bands B, C, D, and E (2 GHz – 22 GHz), the A6A8 YIG-Tuned Mixer (YTX) Assembly functions as both a tracking preselector and an harmonic input mixer. A preselector is a YIG-tuned bandpass filter that tunes in synchronism with the tuning of the spectrum analyzer's 1st LO. This prevents undesired mixing products from being generated in the harmonic

2 1. Frequency Response Adjustments

input mixer. In Band F (the external mixing bands), the output of an external harmonic mixer is connected to the front-panel 321.4 MHz IF INPUT, bypassing the two internal mixers.

The frequency response of the spectrum analyzer is mainly determined by the two input mixers - the A6A6 First Converter Assembly and A6A8 YTX Assembly - and the associated A6A5 Amplifier/Coupler/Load Unit (ACLU) Assembly. Additional signal path components that affect frequency response include the A6J3 RF INPUT Connector Assembly, A6A1 Coaxial RF Switch, A6A2 RF Attenuator, A6A14 Limiter, and semi-rigid cables A6W1, A6W2, A6W3, A6W4, A6W5, and A6W20. When any of these components is adjusted or replaced, the spectrum analyzer frequency response must be verified and adjusted as necessary.

To adjust frequency response, an externally-leveled synthesized sweeper is used as a reference signal source. The synthesized sweeper output is connected to the spectrum analyzer RF INPUT using a low-loss microwave cable, a precision resistive splitter, and a power sensor or planar-doped, barrier diode detector. The power meter or detector output is connected to the synthesized sweeper LEVELING EXT INPUT to precisely level the signal power at the input of the spectrum analyzer. Since the synthesized sweeper and spectrum analyzer both sweep independently of each other, one must be swept quickly relative to the other to review the frequency response across a given frequency band.

The ± 9 Vdc precision reference is initially checked and adjusted. Then, the drive current to the A6A4 Second Converter 3.3 GHz oscillator is set at 15 mA, and the SWEEP+TUNE offset is adjusted for Band A.

Over each frequency band, the leveled reference signal from the synthesized sweeper is used to adjust the spectrum analyzer for optimum flatness and amplitude. In Band A (100 Hz – 2.5 GHz, not preselected), overall RF gain and flatness are adjusted. In Bands B, C, D, and E (2 GHz – 22 GHz), the adjustments necessary to align the A6A8 YIG-Tuned Mixer (YTX) include YTX mixer diode biasing, YTX/YTO tracking and linearity, and YTX delay compensation. After the A6A8 YTX is aligned in each of these four preselected bands, RF Gain and flatness are then optimized with the Preselector DAC centered at the default setting of 32 and the YTX modulated with a 20 Hz sinusoid. In the external mixing bands (Band F), the conversion loss is set to 30 dB and the spectrum analyzer RF gain is adjusted with a 321.4 MHz, -30 dBm reference signal connected to the front panel 321.4 MHz IF INPUT.

Equipment	Synthesized Sweeper	HP 8340A/B
	Power Meter	HP 436A
	Power Sensor (50 MHz to 18 GHz)	HP 8481A
	Frequency Synthesizer	HP 3335A
	Digital Voltmeter	HP 3456A
	Pulse/Function Generator	HP 8116A
	Planar-doped Barrier Diode Detector (10 MHz to 33 GHz)	HP 8473D/8474C
	Power Splitter	HP 11667B

2 1. Frequency Response Adjustments

Adapters:

Type N (f) to BNC (m)	HP 1250-1477
Type N (f) to APC 3.5 (f)	HP 1250-1745
APC 3.5 (f) to APC 3.5 (f)	HP 1250-1749
SMB (m) to SMA (f)	HP 1250-0674
APC 3.5 (m) to Type N (f)	HP 1250-1750
APC 3.5 (m) to Type N (m)	HP 1250-1743
BNC (f) to Dual Banana Plug	HP 1251-2277

Cables:

Low Loss Microwave Test Cable (APC 3.5)	HP 8120-4921
BNC to SMB Snap-on Test Cable	HP 85680-60093

Note

Adjustment procedure 13, "Sweep, DAC, and Main Coil Driver Adjustments" should be performed prior to this procedure, particularly if the A16 Scan Generator Assembly, A19 DAC Assembly, A20 Main Coil Driver Assembly, or A11A3 YTO are adjusted, repaired, or replaced. The YTX TUNE/YTO TUNE 1 (-3 V/GHz) signal from the A19 DAC Assembly directly affects the tuning of both the A11A3 YTO and A6A8 YTX. Adjustments on the A16 Scan Generator Assembly, A19 DAC Assembly, and A20 Main Coil Driver Assembly have a direct affect on YTX/YTO tracking in the preselected (2 GHz – 22 GHz) frequency bands.

Procedure

Preliminary Adjustments

1. Set the spectrum analyzer LINE switch to STANDBY. Turn the spectrum analyzer over to position the RF Section on top, as shown in Figure 3-89 and remove the RF Section bottom cover.

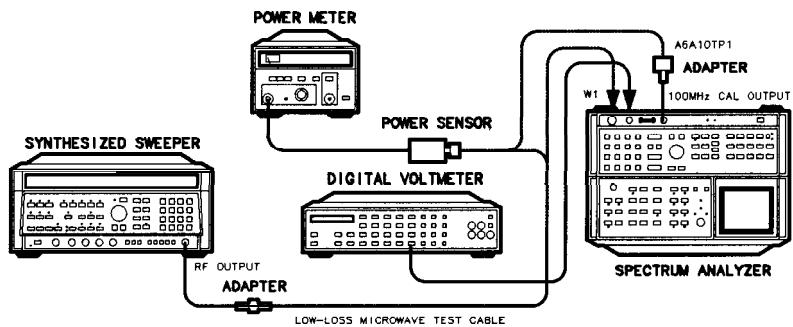

Figure 3-89.
Frequency Response Preliminary Adjustments Setup

2. Connect a jumper between A12TP2 to A12TP3 (LOCK INDICATOR DISABLE) on the A12 Front Panel Interface Assembly in the RF Section. See Figure 3-90 for the location of A12TP2 and A12TP3.

2 1. Frequency Response Adjustments

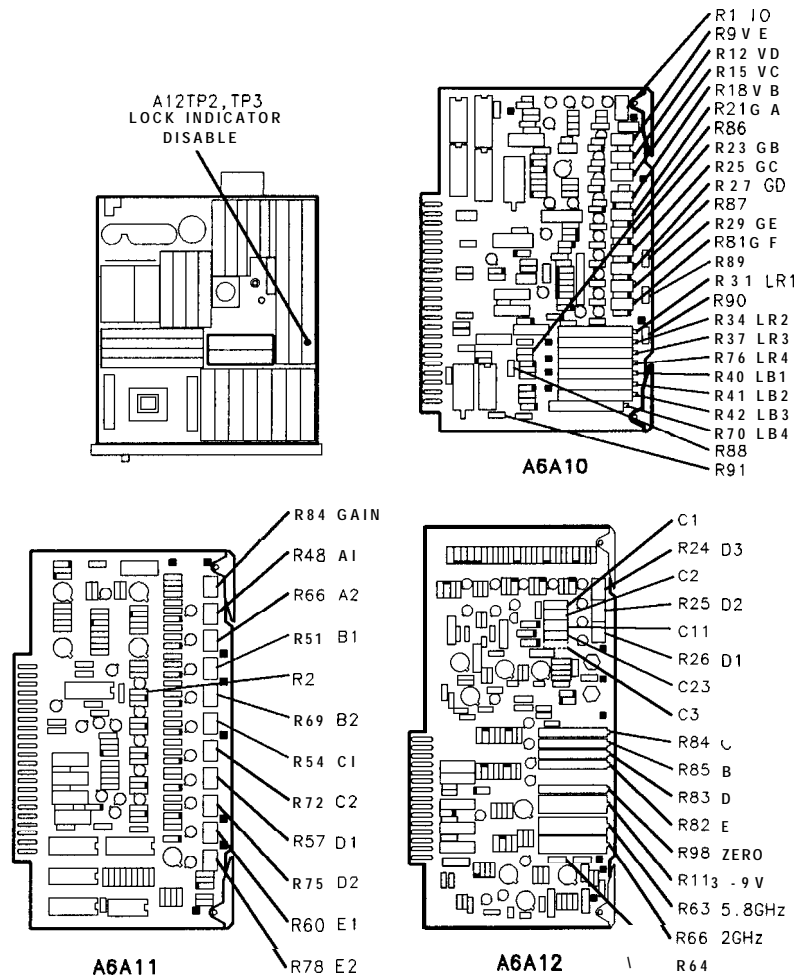

Figure 3-90. Location of Frequency Response Adjustments

3. In the RF Section, disconnect cable 84 (gray/yellow) from **A6A12J1** and cable 82 (gray/red) from **A6A12J2**. Remove the cover from the A6 RF Module, and then reconnect cable 84 (gray/yellow) to **A6A12J1** and cable 82 (gray/red) to **A6A12J2**. See Figure 3-90 for the location of the **A6A12** YTX Driver Assembly and the A6 RF Module.

Note

The spectrum analyzer must be ON continuously (not in STANDBY) and set to the **2-22 GHz** settings for at least 30 minutes prior to performing the following adjustment procedure to allow the temperature and tuning of the **A6A8** YTX and associated circuitry to fully stabilize.

4. Set the RF Section LINE switch to ON, and allow the spectrum analyzer to warm up for at least 30 minutes.
5. Connect the power sensor to the power meter POWER REF output, and zero and calibrate the power meter. Connect the power meter/power sensor to the RF Section front-panel CAL OUTPUT connector using a Type N (f) to BNC (m) adapter, and

2 1. Frequency Response Adjustments

verify that the power meter indication is -10.00 dBm f0.10 dB. If the 100 MHz CAL OUTPUT power level is not within this tolerance, perform adjustment procedure 19, "CAL OUTPUT Adjustment", before continuing with this adjustment procedure.

6. Disconnect the power meter/power sensor from the spectrum analyzer front-panel CAL OUTPUT connector.
7. Press **2-22 GHz** on the synthesized sweeper. Set the synthesized sweeper controls as follows:

CW 21.4 MHz
POWER LEVEL - 15.0 dBm

8. Connect the low-loss microwave test cable to the frequency synthesizer RF OUTPUT using an APC 3.5 (f) to APC 3.5 (f) adapter. Connect the power meter/power sensor to the opposite end of the test cable using a Type N (f) to APC 3.5 (f) adapter.
9. On the synthesized sweeper, press **POWER LEVEL** and adjust the ENTRY knob for a power meter indication of -15.00 dBm f0.03 dB at 21.4 MHz.
10. Disconnect cable 81 (gray/brown) **W1** from **A6A3J3** (21.4 MHz OUT) on the **A6A3** Last Converter Assembly. Disconnect the power sensor from the low-loss microwave test cable, and connect the test cable to cable 81 (gray/brown) **W1** using an SMB (m) to SMA (f) adapter. See Figure 3-90 for the location of **A6A3J3** (21.4 MHz OUT).
11. On the spectrum analyzer, key in **RECALL** 8. Verify that the displayed signal amplitude indicated by the MARKER is -10.00 dBm f0.40 dB. If the displayed signal amplitude is not within this tolerance, perform the following adjustment procedures as necessary to adjust the overall RF gain of the HP 85662A IF/Display Section before continuing with this adjustment procedure:
 5. Log Amplifier Adjustments
 6. Video Processor Adjustments
 10. Step Gain and 18.4 MHz Local Oscillator Adjustments
 8. 21.4 MHz Bandwidth Filter Adjustments
 11. Down/Up Converter Adjustments
12. Disconnect the low-loss microwave test cable from cable 81 (gray/brown) **W1**, and reconnect cable 81 (gray/brown) **W1** to **A6A3J3** (21.4 MHz OUT) on the **A6A3** Last Converter Assembly.
13. Connect the DVM to **A6A10TP1**, and connect the DVM ground to **A6A10TP2**. See Figure 3-90 for the location of **A6A10TP1** and **A6A10TP2**.
14. Adjust **A6A10R1** IO (3.3 GHz Oscillator Drive, to IE on **A6A4** Second Converter) for a DVM indication of -0.15 ±0.01 Vdc. See Figure 3-90 for the location of **A6A10R1**.
15. Connect the DVM to **A6A12TP3** (-9 V), and connect the DVM ground to **A6A12TP2** (YTX COM) in the RF Section. See Figure 3-90 for the location of **A6A12TP3** and **A6A12TP2**.

2 1. Frequency Response Adjustments

Note

± 9 Vdc Reference Supplies adjustment A6A12R113 -9 V affects YTX/YTO tracking, YTX diode bias, and Slope Generator Upper/Lower Segment frequency breakpoints in all preselected frequency bands (Bands B, C, D, and E, 2 GHz – 22 GHz).

16. Adjust 17-turn potentiometer A6A12R113 -9 V for a DVM indication of -9.000 fO.OO1 Vdc. See Figure 3-90 for the location of A6A12R113.
17. Press **2-22 GHz** on the spectrum analyzer. Set the controls of the spectrum analyzer as follows:

CENTER FREQUENCY	0 Hz
FREQUENCY SPAN	0 Hz
SWEEP	SINGLE
18. Use a BNC cable and a BNC (f) to dual banana plug adapter to connect the DVM to the RF Section rear-panel SWEEP+TUNE OUT connector.
19. Adjust 25-turn potentiometer A6A12R98 ZERO for a DVM indication of 0.000 fO.OO1 Vdc. See Figure 3-90 for the location of A6A12R98.
20. Connect the equipment as shown in Figure 3-91, with one resistive output of the power splitter connected to the power meter/power sensor using an APC 3.5 (m) to Type N (f) adapter, and the second resistive output connected to the spectrum analyzer RF INPUT using an APC 3.5 (m) to Type N (m) adapter. Connect the power meter rear panel RECORDER OUTPUT to the synthesized sweeper front panel LEVELING EXT INPUT.
21. Press **INSTR PRESET** on the synthesized sweeper. Set the controls of the synthesized sweeper as follows:

CW	100 MHz
POWER LEVEL	-9.0 dBm
RF	on
LEVELINGINT

Band A, 10 MHz to 2.5 GHz

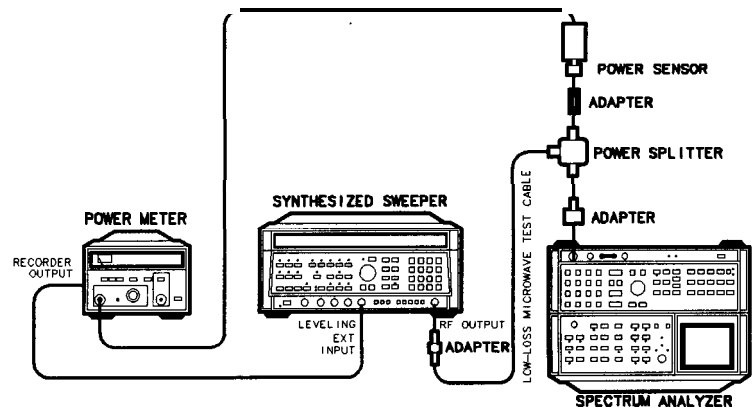

Figure 3-91.
Frequency Response Adjustments Setup (10 MHz to 2.5 GHz)

2 1. Frequency Response Adjustments

22. On the synthesized sweeper, press **POWER LEVEL** and adjust the ENTRY knob as necessary for a power meter indication of $-15.00 \text{ dBm} \pm 2.00 \text{ dB}$ at 100 MHz.
23. On the power meter, press **RANGE HOLD** (turning it on).
24. On the synthesized sweeper, press **POWER LEVEL** and adjust the ENTRY knob for a power meter indication of $-10.00 \text{ dBm} \pm 0.03 \text{ dB}$ at 100 MHz.
25. On the synthesized sweeper, press **METER LEVELING** and adjust the ENTRY knob (REF in **dBV** with ATN: 0 dB) for a power meter indication of $-10.00 \text{ dBm} \pm 0.03 \text{ dB}$ at 100 MHz.

Note

Do not vary the synthesized sweeper POWER LEVEL setting (internal leveling) or METER REF and METER ATN settings (external power meter leveling) for the remaining steps in this section of the adjustment procedure. The frequency response adjustments are referenced to the -10.00 dBm power level at 100 MHz.

26. Press **2-22 GHz** on the spectrum analyzer. Set the RF Section front-panel AMPTD CAL control to the approximate center of its adjustment range.

Note

Do not vary the spectrum analyzer front-panel AMPTD CAL control setting for the remaining steps in this adjustment procedure.

27. Set (Band A Lower Segment) **A6A11R48 A1** and (Band A Upper Segment) **A6A11R66 A2** each to the approximate center of its adjustment range.

Then, adjust **A6A11R84 GAIN** fully clockwise for maximum RF gain. See Figure 3-90 for the locations of **A6A11R48 A1**, **A6A11R66 A2**, and **A6A11R84 GAIN**.
28. On the spectrum analyzer, key in **RECALL 8**, **REFERENCE LEVEL** -4 dBm and then press the **UP** and **DOWN** keys as necessary to position the peak of the displayed 100 MHz signal within one division of the top graticule line. Key in **MARKER PEAK SEARCH**, **MARKER** **Δ** on the spectrum analyzer to position two markers on the peak of the displayed 100 MHz signal.
29. Readjust **A6A11R84 GAIN** counterclockwise to decrease the RF gain $5.00 \text{ dB} \pm 0.02 \text{ dB}$, as indicated by the **MARKER A** indication on the spectrum analyzer display.
30. On the spectrum analyzer, key in **RECALL 8**.
31. Adjust 17-turn potentiometer (Band A Step Gain) **A6A10R21 GA** to adjust the amplitude of the displayed 100 MHz signal to $-10.00 \text{ dBm} \pm 0.10 \text{ dB}$. Adjust **A6A10R21 GA** counterclockwise to increase the signal level, and clockwise to decrease the signal level. If **A6A10R21 GA** does not have sufficient range, adjust the amplitude of the 100 MHz displayed signal as close as possible to -10.00 dBm .

2 1. Frequency Response Adjustments

32. On the spectrum analyzer, key in **(2-22 GHz)**, **(SHIFT)** TRACE A **(MAX HOLD)**^b. Set the spectrum analyzer controls as follows:

START FREQ 10 MHz
 STOP FREQ 2.5 GHz
 RESBW..3 MHz
 REFERENCE LEVEL -7 dBm
 LOG SCALE 1 dB/DIV
 SWEEP TIME2s

33. Set the synthesized sweeper controls as follows:

START FREQ 10 MHz
 STOP FREQ 2.5 GHz
 RF on
 LEVELING INT
 SWEEP TIME 30 ms
 SWEEP CONT

34. On the spectrum analyzer, key in TRACE A **(@LEARN-WRITE)**, **(SWEEP TIME)** 2s, **(MARKER)** **(NORMAL)** 500 MHz, **(HOLD)**. As the spectrum analyzer completes each sweep, a series of approximately 18 new responses should be displayed, as shown in Figure 3-92. The peaks of these responses coarsely outline the spectrum analyzer frequency response.

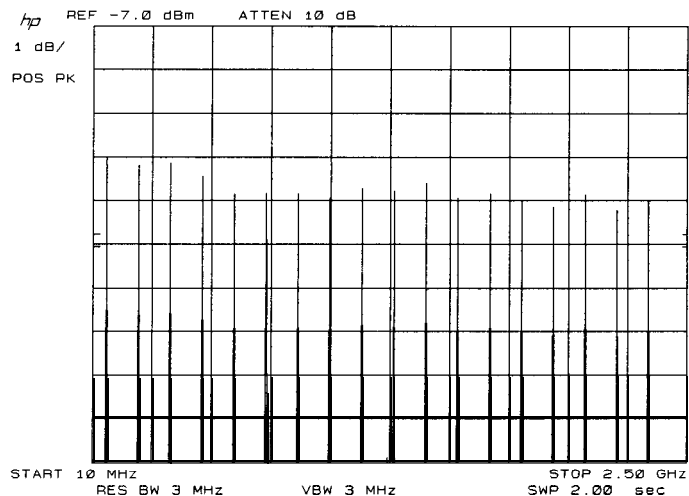

Figure 3-92.
Typical Coarse Frequency Response (10 MHz – 2.5 GHz)

35. Gradually readjust (Band A Lower Segment) **A6A11R48 A1** and (Band A Upper Segment) **A6A11R66 A2** for maximum flatness of the displayed signal responses. The adjustments are interactive, with **A6A11R48 A1** having the most effect on the level of the displayed signals below approximately 500 MHz (the marker position), and **A6A11R66 A2** having the most effect on the level of the displayed signals above approximately 500 MHz. Adjust **A6A11R48 A1** counterclockwise to increase the level of the displayed signal responses below 500 MHz. Adjust **A6A11R66 A2**

2 1. Frequency Response Adjustments

clockwise to increase the level of the displayed signal responses above 500 MHz.

Note

It might be helpful to increase or decrease the spectrum analyzer [SWEEP TIME] setting while adjusting A6A11R66 A2 and A6A11R48 A1, particularly when making fine adjustments. An increase in spectrum analyzer sweep time results in closer spacing of the displayed responses, but slows the adjustment.

36. On the synthesized sweeper, key in (METER) LEVELING, [SWEEP TIME] 150s, SWEEP (SINGLE), SWEEP (SINGLE).
37. On the spectrum analyzer, key in SWEEP TIME (AUTO), TRACE B (CLEAR-WRITE), TRACE B (MAX HOLD).
38. On the synthesized sweeper, press SWEEP (SINGLE) and wait for a sweep to complete (150 seconds) and the SWEEP LED to turn off. As the synthesized sweeper tunes from 10 MHz to 2.5 GHz, the input signal should be displayed as a TRACE A response, and the spectrum analyzer frequency response should be displayed as TRACE B, as shown in Figure 3-93.

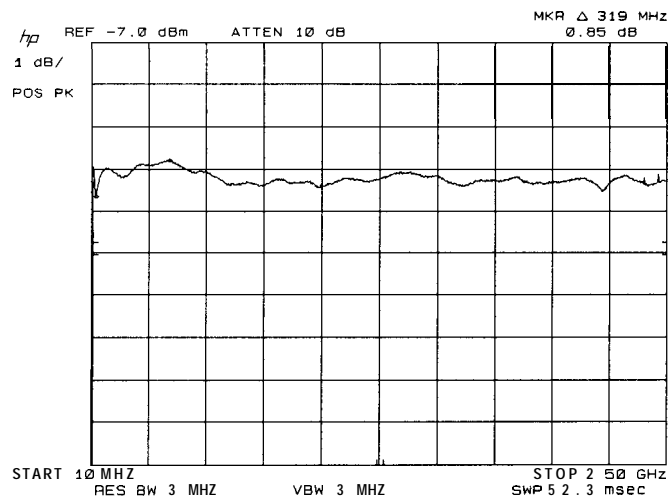

Figure 3-93.
Typical Frequency Response (10 MHz – 2.5 GHz)

39. On the spectrum analyzer, key in TRACE B (VIEW), TRACE A (BLANK), MARKER (NORMAL) and use the DATA knob to position a marker on the lowest point on the TRACE B waveform. Then, press MARKER (Δ), MARKER (PEAK SEARCH) to position a second marker on the highest point on the TRACE B waveform. Total peak-to-peak deviation of the displayed trace should be less than 1.20 dB.

Note

To provide the spectrum analyzer with a 10 MHz to 2.5 GHz input signal of sufficient flatness for measuring frequency response, the synthesized sweeper must be leveled externally with a power meter with a relatively slow sweep time (at least 40 seconds). However, relative flatness adjustments are made with the synthesized sweeper

2 1. Frequency Response Adjustments

set to internal leveling, which introduces minor leveling errors but permits much faster sweep times.

40. Repeat steps 33 through 39 as necessary until the total peak-to-peak deviation of the TRACE B waveform is less than 1.20 dB. Leave the TRACE B reference waveform in VIEW for steps 33 through 36 to indicate which portions of the frequency response waveform require relative adjustment.

If necessary, change the value of factory-select component **A6A10R2** to shift the Band A frequency breakpoint determining the adjustment ranges of **A6A11R48 A1** and **A6A11R66 A2**. A decrease in the value of **A6A10R2** shifts the Band A frequency breakpoint higher in frequency, widening the Band A Lower Segment and narrowing the Band A Upper Segment. Conversely, an increase in the value of **A6A10R2** shifts the Band A frequency breakpoint lower in frequency. See Table 3-3 for the acceptable range of values for **A6A10R2**, and Table 3-4 for HP part numbers. See Figure 3-90 for the location of **A6A10R2**.

41. On the synthesized sweeper, key in **(CW)** 100 MHz, **(METER)** LEVELING.
42. On the spectrum analyzer, key in **(RECALL)** 8, MARKER **(PEAK SEARCH)** to position a marker on the peak of the displayed 100 MHz signal.
43. With the RF Section front-panel AMPTD CAL control still set to the approximate center of its adjustment range, readjust 17-turn potentiometer (Band A Step Gain) **A6A10R21 GA** to adjust the amplitude of the displayed 100 MHz marker to -10.00 dBm f0.01 dB. Adjust **A6A10R21 GA** counterclockwise to increase the signal level, and clockwise to decrease the signal level.

For **A6A10** Miscellaneous Bias/Relay Driver Assembly, HP P/N 85660-60322 (HP 85660A/B RF Sections with serial number prefix 2747A or above):

If **A6A10R21 GA** does not have sufficient range to adjust the amplitude of the 100 MHz displayed signal to -10.00 dBm, change the value of factory-select component **A6A10R86**. Increase the value of **A6A10R86** to decrease the signal level, and decrease the value of **A6A10R86** to increase the signal level. See Table 3-3 for the acceptable range of values for **A6A10R86**, and Table 3-4 for HP part numbers. See Figure 3-90 for the location of **A6A10R86**.

44. On the synthesized sweeper, key in **(INT)** LEVELING, RF (OFF). Disconnect the power splitter from the spectrum analyzer RF INPUT.
45. On the power meter, press **(RANGE HOLD)** (turning it off). Disconnect the power meter rear panel RECORDER OUTPUT from the synthesized sweeper front panel LEVELING EXT INPUT.

2 1. Frequency Response Adjustments

Band B, 2.0 GHz to 5.8 GHz

46. On the spectrum analyzer, key in **2-22 GHz**, **FREQUENCY SPAN** **0** Hz, **CENTER FREQUENCY** **4 GHz**, **SWEEP** **SINGLE**.
47. Connect the DVM to A6A12TP3 (-9 V), and connect the DVM ground to A6A12TP2 (YTX COM) in the RF Section. See Figure 3-90 for the location of A6A12TP3 and A6A12TP2.

Note

± 9 Vdc Reference Supplies adjustment A6A12R113 -9 V affects YTX/YTO tracking, YTX diode bias, and Slope Generator Upper/Lower Segment frequency breakpoints in all preselected frequency bands (Bands B, C, D, and E, 2 GHz – 22 GHz).

48. If necessary, readjust 17-turn potentiometer A6A12R113 -9 V for a DVM indication of -9.000 f0.OO1 Vdc.
49. Connect the DVM to A6A12TP5 (-525 V/GHz). Leave the DVM ground connected to A6A12TP2 (YTX COM). See Figure 3-90 for the location of A6A12TP5.
50. Adjust 22-turn (YTX IF Offset) potentiometer A6A12R85 B for a DVM indication of -2.100 \pm 0.001 Vdc. See Figure 3-90 for the location of A6A12R85 B.

Note

YTX Linearity adjustments A6A10R40 LB1, A6A10R41 LB2, A6A10R42 LB3, A6A10R70 LB4, A6A10R31 LR1, A6A610R34 LR2, A6A10R37 LR3, and A6A10R76 LR4 affect YTX/YTO tracking in all preselected frequency bands (Bands B, C, D, and E, 2 GHz – 22 GHz). These adjustments overlap and have a cumulative effect on YTX/YTO tracking with increasing frequency.

51. If the A6A10 Miscellaneous Bias/Relay Driver Assembly or A6A7 YTX Current Driver Assembly has been repaired or replaced, or if the A6A8 YTX has been replaced, adjust 22-turn (YTX Linearity) potentiometers A6A10R40 LB1, A6A10R41 LB2, A6A10R42 LB3, A6A10R70 LB4, A6A10R31 LR1, A6A610R34 LR2, A6A10R37 LR3, and A6A10R76 LR4 fully counterclockwise. See Figure 3-90 for the location of YTX Linearity adjustments A6A10R40 LB1, A6A10R41 LB2, A6A10R42 LB3, A6A10R70 LB4, A6A10R31 LR1, A6A610R34 LR2, A6A10R37 LR3, and A6A10R76 LR4.
52. On the spectrum analyzer, key in **2-22 GHz**, **SHIFT** **PRESEL PEAK** =, **SHIFT** **TRACE A** **MAX HOLD** ^b. Set the spectrum analyzer controls as follows:

START FREQ	2.0 GHz
STOP FREQ	5.8 GHz
RES BW	3 MHz
REFERENCE LEVEL	-7 dBm
LOG SCALE	10 dB/DIV
SWEEP TIME	500 ms

53. Connect the equipment as shown in Figure 3-94, with one resistive output of the power splitter connected to the power meter/power sensor using an APC 3.5 (m) to Type N (f) adapter, and the second resistive output connected to the diode detector. Connect the diode detector SMC output to the synthesized

2 1. Frequency Response Adjustments

sweeper front panel LEVELING EXT INPUT using a BNC to SMB snap-on test cable.

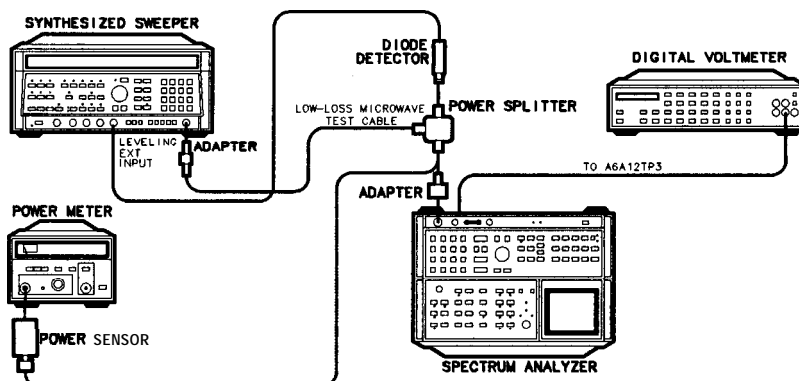

Figure 3-94.
Frequency Response Adjustments Setup (2.0 GHz to 22.0 GHz)

54. Press **2-22 GHz** on the synthesized sweeper. Set the controls of the synthesized sweeper as follows:
- | | | |
|-------------|-------|----------|
| CW | | 100 MHz |
| POWER LEVEL | | -4.0 dBm |
| RF | | on |
| LEVELING | | .INT |
55. On the synthesized sweeper, press **POWER LEVEL** and adjust the ENTRY knob for a power meter indication of $-10.00 \text{ dBm} \pm 0.03 \text{ dB}$ at 100 MHz. Then, press **XTAL** LEVELING and adjust the ENTRY knob (REF in dBV with ATN: 0 dB) for a power meter indication of $-10.00 \text{ dBm} \pm 0.03 \text{ dB}$ at 100 MHz.

Note

Do not vary the synthesized sweeper POWER LEVEL setting (internal leveling) or XTAL REF and XTAL ATN settings (external diode detector leveling) for the remaining steps in this adjustment procedure. The frequency response adjustments are referenced to the -10.00 dBm power level at 100 MHz.

56. Disconnect the power sensor from the power splitter, and connect this power splitter resistive output to the spectrum analyzer RF INPUT using an APC 3.5 (m) to Type N (m) adapter.
57. On the synthesized sweeper, key in **CW** 5.7 GHz.

Note

YTX Drive adjustments A6A12R63 5.8 GHz and A6A12R66 2 GHz are interactive and affect YTX/YTO tracking in all preselected frequency bands (Bands B, C, D, and E, 2 GHz – 22 GHz).

58. Adjust 25-turn (YTX Drive) potentiometer A6A12R63 5.8 GHz and 17-turn (Band B YTX Diode Bias) potentiometer A6A10R18 VB as necessary to maximize the amplitude of the 5.7 GHz

21. Frequency Response Adjustments

signal on the spectrum analyzer display. See Figure 3-90 for the locations of A6A12R63 5.8 GHz and A6A10R18 VB.

Note

If A6A12 YTX Driver Assembly is HP P/N 85660-60235 (HP 85660A/B RF Sections serial number prefixed 2503A or above), and A6A12R63 5.8 GHz does not have sufficient adjustment range in this step (or steps 61, 66, or 75), check the value of factory-select component A6A12R64. The normal value of 15K ohms (HP P/N 0698-7133) for A6A12R64 provides sufficient adjustment range of A6A12R63 5.8 GHz for most A6A8 YTX assemblies. The alternate value of 13.35613 ohms (HP P/N 0698-8079) for A6A12R64 provides additional range of A6A12R63 5.8 GHz in cases where the adjustment will otherwise not peak the A6A8 YTX tracking sufficiently. See Figure 3-90 for the location of A6A12R64.

59. On the synthesized sweeper, key in **CW** 2.1 GHz.
60. Adjust 25-turn (YTX Drive) potentiometer A6A12R66 2 GHz as necessary to maximize the amplitude of the 2.1 GHz signal on the spectrum analyzer display. See Figure 3-90 for the location of A6A12R66 2 GHz.
61. Repeat steps 57 through 60 as necessary until no further adjustment is necessary.
62. On the synthesized sweeper, key in **CW** 3.9 GHz.
63. On the spectrum analyzer, key in MARKER **NORMAL**, MARKER **PEAK SEARCH** to position a marker at the peak of the displayed 3.9 GHz signal. Adjust 17-turn (Band B Step Gain) potentiometer A6A10R23 GB as necessary to adjust the amplitude of the displayed 3.9 GHz marker to -10.00 dBm f0.10 dB. Adjust A6A10R23 GB counterclockwise to increase the signal level, and clockwise to decrease the signal level. If A6A10R23 GB does not have sufficient range, adjust the amplitude of the displayed 3.9 GHz marker as close as possible to -10.00 dBm. See Figure 3-90 for the location of A6A10R23 GB.
64. On the spectrum analyzer, key in LOG SCALE **ENTER dB/DIV** 2 dB, MARKER **NORMAL**.
65. On the synthesized sweeper, key in **CW** 5.7 GHz.
66. On the spectrum analyzer, key in MARKER **PEAK SEARCH** to position a marker at the peak of the displayed 5.7 GHz signal. Readjust 25-turn (YTX Drive) potentiometer A6A12R63 5.8 GHz as necessary to maximize the amplitude of the 5.7 GHz signal on the spectrum analyzer display.
67. On the synthesized sweeper, key in **CW** 2.1 GHz.
68. On the spectrum analyzer, key in MARKER **PEAK SEARCH** to position a marker at the peak of the displayed 2.1 GHz signal. Readjust 25-turn (YTX Drive) potentiometer A6A12R66 2 GHz as necessary to maximize the amplitude of the 2.1 GHz signal on the spectrum analyzer display.
69. Repeat steps 65 through 68 as necessary until no further adjustment is necessary.

2 1. Frequency Response Adjustments

70. Set the synthesized sweeper controls as follows:

START FREQ 2.0 GHz
STOP FREQ 5.8 GHz
RF on
LEVELING XTAL
SWEEP TIME 30 ms
SWEEP CONT

71. On the spectrum analyzer, key in TRACE A [CLEAR-WRITE], [SWEEP TIME] 2s, MARKER (OFF), [HOLD]. As the spectrum analyzer completes each sweep, a series of approximately 22 new responses should be displayed, as shown in Figure 3-95. The peaks of these responses coarsely outline the spectrum analyzer frequency response.

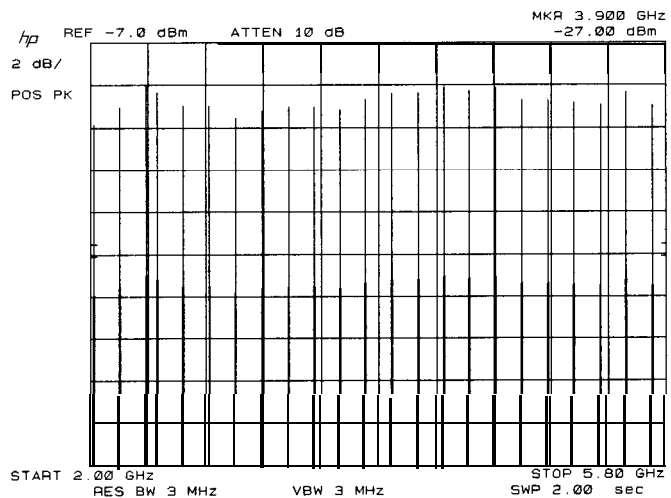

Figure 3-95.
Typical Coarse Frequency Response (2 GHz - 5.8 GHz)

72. Gradually adjust (Band B Lower Segment) A6A11R51 B1 and (Band B Upper Segment) A6A11R69 B2 for maximum flatness of the displayed signal responses. The adjustments are interactive, with A6A11R51 B1 having the most effect on the level of the displayed signals below mid-band (approximately 3.9 GHz), and A6A11R69 B2 having the most effect on the level of the displayed signals above mid-band. Adjust A6A11R51 B1 counterclockwise to increase the level of the displayed signal responses below mid-band. Adjust A6A11R69 B2 clockwise to increase the level of the displayed signal responses above mid-band. See Figure 3-90 for the locations of A6A11R51 B1 and A6A11R69 B2.

Note

It might be helpful to increase or decrease the spectrum analyzer [SWEEP TIME] setting while adjusting A6A11R66 B2 and A6A11R48 B1, particularly when making fine adjustments. An increase in spectrum analyzer sweep time results in closer spacing of the displayed responses, but slows the adjustment.

2 1. Frequency Response Adjustments

73. On the spectrum analyzer, key in **(SWEEP TIME) 5s**, **LOG SCALE** **(ENTER dB/DIV) 1 dB**, **TRACE B (VIEW)**, **(SAVE) 4**, **(SWEEP TIME) 2s**, **TRACE B (BLANK)**, **(HOLD)**.
74. Readjust 17-turn (YTX Diode Bias) potentiometer **A6A10R18 VB** to maximize the overall level of the displayed signal responses from **2.0 GHz** to **5.8 GHz** on the spectrum analyzer display.
75. Readjust 25-turn (YTX Drive) potentiometers **A6A12R63 5.8 GHz** and **A6A12R66 2 GHz** to maximize the overall level of the displayed signal responses from **2.0 GHz** to **5.8 GHz** on the spectrum analyzer display.
76. Gradually readjust (Band B Lower Segment) **A6A11R51 B1** and (Band B Upper Segment) **A6A11R69 B2** as necessary for maximum flatness of the displayed signal responses.
77. On the spectrum analyzer, key in **SWEEP (SINGLE)**, **(SWEEP TIME) 150s**, **TRACE A (BLANK)**, **TRACE B (MAX HOLD)**, **(SAVE) 6**, **TRACE B (CLEAR-WRITE)**, **(SAVE) 5**, **(HOLD)**.
78. Press **SWEEP (SINGLE)** on the spectrum analyzer and wait for the sweep to complete (150 seconds) and the SWEEP LED to turn off. As the spectrum analyzer tunes from **2.0 GHz** to **5.8 GHz**, the spectrum analyzer frequency response should be displayed as **TRACE B**, as shown in Figure 3-96.

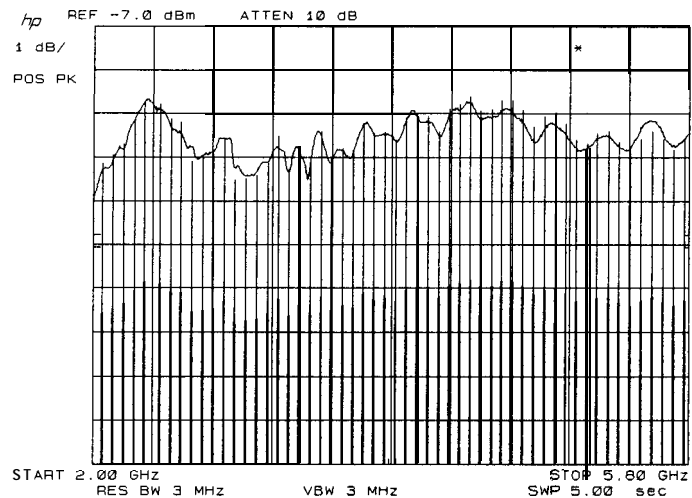

Figure 3-96.
Typical Frequency Response (2.0 GHz – 5.8 GHz)

79. On the spectrum analyzer, key in **(RECALL) 4**, **(HOLD)** and repeat steps 74 through 76 as necessary.
80. On the spectrum analyzer, key in **(RECALL) 5** and wait for the sweep to complete (150 seconds) and the SWEEP LED to turn off.

2 1. Frequency Response Adjustments

81. On the spectrum analyzer, key in **RECALL** 4, **SHIFT** **GHz** / and use the DATA knob to gradually change the PRESELECTOR DAC setting from 32, maximizing the level of the TRACE A displayed signal responses at the lowest point on the TRACE B waveform. Note the PRESELECTOR DAC setting.
82. On the spectrum analyzer, key in **RECALL** 6, **SHIFT** **GHz** / and enter in the PRESELECTOR DAC setting from step 81. Press SWEEP (**SINGLE**) and wait for the sweep to complete (150 seconds) and the SWEEP LED to turn off.
83. Repeat steps 81 and 82 until the level of the lowest point on the TRACE B waveform does not change. Repeat step 82 with a PRESELECTOR DAC value of 30 and 34.
84. On the spectrum analyzer, key in TRACE B [VIEW), MARKER **NORMAL** and use the DATA knob to position a marker on the lowest point on the TRACE B waveform. Then, press MARKER **Δ**, MARKER **PEAK SEARCH** to position a second marker on the highest point on the TRACE B waveform. Note the total peak-to-peak deviation of the displayed trace.

Band B total peak-to-peak deviation: _____ dB

85. On the spectrum analyzer, press MARKER **NORMAL** and note the frequency of the highest point on the TRACE B waveform.

Band B highest point: _____ GHz

86. Repeat steps 79 through 85 if necessary until the total peak-to-peak deviation of the TRACE B waveform is less than 3.40 dB. See the TRACE B reference waveform to indicate which portions of the frequency response waveform require relative adjustment.
87. On the spectrum analyzer, key in **RECALL** 4, **HOLD**.
88. On the synthesized sweeper, press **CW** and enter the frequency recorded in step 85, positioning the displayed TRACE A signal response at the highest point on the TRACE B waveform.

Note

The RF Section front-panel AMPTD CAL control should still be set to the approximate center of its adjustment range from step 26.

89. On the spectrum analyzer, key in MARKER **NORMAL**, MARKER **PEAK SEARCH** to position a marker at the peak of the displayed TRACE A signal response. Adjust 17-turn (Band B Step Gain) potentiometer A6A10R23 GB to adjust the amplitude of the marker to -10.00 dBm + (1/2 of Band B total peak-to-peak deviation) ±0.01 dB. Adjust A6A10R23 GB counterclockwise to increase the signal level, and clockwise to decrease the signal level.

Note

If the A6A10 Miscellaneous Bias/Relay Driver Assembly is HP P/N 85660-60322 (HP 85660A/B RF Sections with serial number prefix 2747A or above), and A6A10R23 GB does not have sufficient range, change the value of factory-select component A6A10R87. Increase the value of A6A10R87 to decrease the signal level, and decrease the value of A6A10R87 to increase the signal level. See Table 3-3 for the

2 1. Frequency Response Adjustments

acceptable range of values for A6A10R87, and Table 3-4 for HP part numbers. See Figure 3-90 for the location of A6A10R87.

Band C, 5.8 GHz to 12.5 GHz

90. On the spectrum analyzer, key in **(2-22 GHz)**, **(SHIFT) (PRESEL PEAK)** =, **(SHIFT) TRACE A (MAX HOLD)** ^b. Set the spectrum analyzer controls as follows:

START FREQ	5.8 GHz
STOP FREQ	12.5 GHz
RES BW	3 MHz
REFERENCE LEVEL	-7 dBm
LOG SCALE	10 dB/DIV
SWEEP TIME	500 ms

91. On the synthesized sweeper, key in **(CW)** 6.0 GHz.
-

Note

The POWER LEVEL of the synthesized sweeper should still be leveled to a calibrated -10.00 dBm at 100 MHz at the spectrum analyzer RF INPUT from step 55.

92. Adjust 22-turn (IF Offset) potentiometer A6A12R84 C and 17-turn (YTX Bias) potentiometer A6A10R15 VC for maximum signal amplitude at 6.0 GHz on the spectrum analyzer display. See Figure 3-90 for the locations of A6A12R84 C and A6A10R15 VC.
93. On the spectrum analyzer, key in MARKER **(NORMAL)**, MARKER **(PEAK SEARCH)** to position a marker at the peak of the displayed 6.0 GHz signal. Adjust 17-turn (Band C Step Gain) potentiometer A6A10R25 GC as necessary to adjust the amplitude of the displayed 6.0 GHz marker to -10.00 dBm f0.10 dB. Adjust A6A10R25 GC counterclockwise to increase the signal level, and clockwise to decrease the signal level. If A6A10R25 GC does not have sufficient range, adjust the amplitude of the displayed 6.0 GHz marker as close as possible to -10.00 dBm. See Figure 3-90 for the location of A6A10R25 GC.
94. On the spectrum analyzer, key in LOG SCALE **(ENTER dB/DIV)** 2 dB, MARKER **(NORMAL)**.
95. Readjust 22-turn (IF Offset) potentiometer A6A12R84 C as necessary to maximize the amplitude of the 6.0 GHz signal on the spectrum analyzer display.
96. Set the synthesized sweeper controls as follows:
- | | |
|------------------|----------|
| START FREQ | 5.8 GHz |
| STOP FREQ | 12.5 GHz |
| RF | on |
| LEVELING | .XTAL |
| SWEEP TIME | 30 ms |
| SWEEP | CONT |
97. On the spectrum analyzer, key in TRACE A **(CLEAR-WRITE)**, **(SWEEP TIME)** 2s, MARKER **(OFF)**, **(HOLD)**. As the spectrum analyzer completes each sweep, a series of approximately 23 new responses should be displayed, as shown in Figure 3-97. The

2 1. Frequency Response Adjustments

peaks of these responses coarsely outline the spectrum analyzer frequency response.

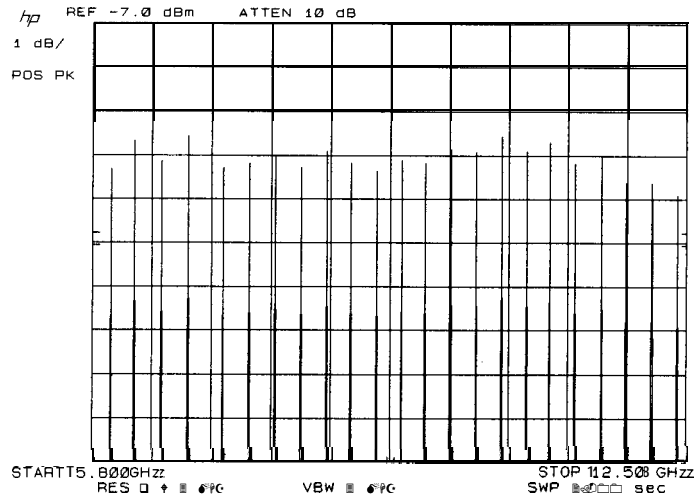

Figure 3-97.

Typical Coarse Frequency Response (5.8 GHz – 12.5 GHz)

Note

It might be helpful to temporarily change the spectrum analyzer @SWEEP TIME] setting while adjusting frequency response, particularly when making fine adjustments. An increase in spectrum analyzer sweep time results in closer spacing of the displayed responses, but slows the adjustment. Do not decrease the (SWEEP TIME) setting below 1s. before the YTX Delay Compensation adjustments have been made.

98. Gradually adjust (Band C Lower Segment) A6A11R54 C1 and (Band C Upper Segment) A6A11R72 C2 for maximum flatness of the displayed signal responses. The adjustments are interactive, with A6A11R54 C1 having the most effect on the level of the displayed signals below mid-band (approximately 9.1 GHz), and A6A11R72 C2 having the most effect on the level of the displayed signals above mid-band. Adjust A6A11R54 C1 counterclockwise to increase the level of the displayed signal responses below mid-band. Adjust A6A11R72 C2 clockwise to increase the level of the displayed signal responses above mid-band. See Figure 3-90 for the locations of A6A11R54 C1 and A6A11R72 C2.

Note

If the displayed signals at the high end of the band drop off by more than 2-3 dB, center A6A11R72 C2 and proceed to step 99.

99. On the spectrum analyzer, key in (SWEEP TIME) 5s, LOG SCALE (ENTER dB/DIV) 1 dB, TRACE B (VIEW), (SAVE) 4, (SWEEP TIME) 2s, TRACE B (BLANK), [HOLD].
100. Readjust 17-turn (YTX Diode Bias) potentiometer A6A10R15 VC to maximize the overall level of the displayed signal responses from 5.8 GHz to 12.5 GHz on the spectrum analyzer display. Then, adjust A6A10R15 VC clockwise until signal responses at the high end of the band drop in amplitude by approximately 0.5 dB.

2 1. Frequency Response Adjustments

101. Readjust 22-turn (IF Offset) potentiometer **A6A12R84 C** as necessary to maximize the **overall** level of the displayed signal responses from 5.8 GHz to 12.5 GHz on the spectrum analyzer display. If the displayed signal responses above mid-band drop off in amplitude and peak at a different setting of **A6A12R84 C** perform the following steps:
 - a. Perform step 51 if it has not already been performed.
 - b. Readjust 22-turn (IF Offset) potentiometer **A6A12R84 C** to maximize the displayed signal responses at the low end of the band.
 - c. Key in MARKER **(NORMAL)** and position the marker at the point in the band where the signal responses begin to **fall** off from their maximum value.
 - d. Adjust 22-turn (YTX Linearity) potentiometer **A6A10R40 LB1** clockwise until the displayed signal responses at the high end of the band begin to drop. Continue to adjust **A6A10R40 LB1** until the **rolloff** point aligns with the position of the marker. See Figure 3-90 for the locations of **A6A10R40 LB1** and **A6A10R31 LR1**.
 - e. Readjust 22-turn (YTX Linearity) potentiometer **A6A10R31 LR1** clockwise to maximize the displayed signal responses at the high end of the band.
 - f. Readjust **A6A12R84 C** and **A6A10R31 LR1** as necessary to maximize the displayed signal responses from 5.8 GHz to 12.5 GHz on the spectrum analyzer display.
102. Gradually readjust (Band C Lower Segment) **A6A11R54 C1** and (Band C Upper Segment) **A6A11R72 C2** as necessary for maximum flatness of the displayed signal responses.
103. On the spectrum analyzer, key in SWEEP **(SINGLE)**, **(SWEEP TIME)** 150s, TRACE A **(BLANK)**, TRACE B **(MAX HOLD)**, **(SAVE)** 6, TRACE B **(CLEAR-WRITE)**, **(SAVE)** 5, **(HOLD)**.
104. Press SWEEP **(SINGLE)** on the spectrum analyzer and wait for the sweep to complete (150 seconds) and the SWEEP LED to turn off. As the spectrum analyzer tunes from 5.8 GHz to 12.5 GHz, the spectrum analyzer frequency response should be displayed as TRACE B, as shown in Figure 3-98.

2 1. Frequency Response Adjustments

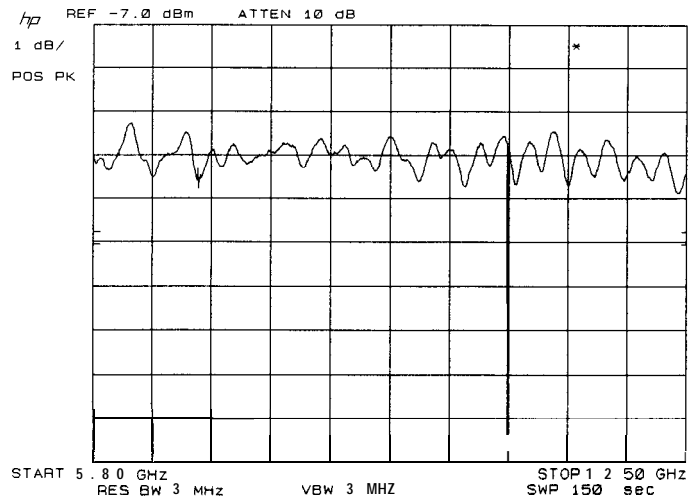

Figure 3-98.
Typical Frequency Response (5.8 GHz – 12.5 GHz)

105. On the spectrum analyzer, key in **RECALL** 4, **HOLD** and repeat steps 100 through 102 as necessary.
106. On the spectrum analyzer, key in **RECALL** 5 and wait for the sweep to complete (150 seconds) and the SWEEP LED to turn Off.
107. On the spectrum analyzer, key in **RECALL** 4, **SHIFT** **GHz** / and use the DATA knob to gradually change the PRESELECTOR DAC setting from 32, maximizing the level of the TRACE A displayed signal responses at the lowest point on the TRACE B waveform. Note the PRESELECTOR DAC setting.
108. On the spectrum analyzer, key in **RECALL** 6, **SHIFT** **GHz** / and enter in the PRESELECTOR DAC setting from step 107. Press SWEEP **SINGLE** and wait for the sweep to complete (150 seconds) and the SWEEP LED to turn off.
109. Repeat steps 107 and 108 until the level of the lowest point on the TRACE B waveform does not change. Repeat step 108 with a PRESELECTOR DAC value of 30 and 34.
110. On the spectrum analyzer, key in TRACE B [VIEW], MARKER **NORMAL** and use the DATA knob to position a marker on the lowest point on the TRACE B waveform. Then, press MARKER [a, MARKER **PEAK SEARCH**] to position a second marker on the highest point on the TRACE B waveform. Note the total peak-to-peak deviation of the displayed trace.
Band C total peak-to-peak deviation: _____ dB
111. On the spectrum analyzer, press MARKER **NORMAL** and note the frequency of the highest point on the TRACE B waveform.
Band C highest point: _____ GHz
112. Repeat steps 105 through 111 if necessary until the total peak-to-peak deviation of the TRACE B waveform is less than

2 1. Frequency Response Adjustments

3.40 dB. See the TRACE B reference waveform to indicate which portions of the frequency response waveform require relative adjustment. 113. On the spectrum analyzer, key in **RECALL** 4, **HOLD**.

113. On the synthesized sweeper, press **CW** and enter the frequency recorded in step 111, positioning the displayed TRACE A signal response at the highest point on the TRACE B waveform.

Note

The RF Section front-panel AMPTD CAL control should still be set to the approximate center of its adjustment range from step 26.

114. On the spectrum analyzer, key in **MARKER** **NORMAL**, **MARKER** **PEAK SEARCH** to position a marker at the peak of the displayed TRACE A signal response. Adjust 17-turn (Band C Step Gain) potentiometer **A6A10R25** GC to adjust the-amplitude of the marker to $-10.00 \text{ dBm} + (1/2 \text{ of Band C total peak-to-peak deviation}) \pm 0.01 \text{ dB}$. Adjust **A6A10R25** GC counterclockwise to increase the signal level, and clockwise to decrease the signal level.

Note

If **A6A10** Miscellaneous Bias/Relay Driver Assembly is HP P/N 85660-60322 (HP **85660A/B** RF Sections with serial number prefix 2747A or above), and **A6A10R25** GC does not have sufficient range, change the value of factory-select component **A6A10R88**. Increase the value of **A6A10R88** to decrease the signal level, and decrease the value of **A6A10R88** to increase the signal level. See Table 3-3 for the acceptable range of values for **A6A10R88**, and Table 3-4 for HP part numbers. See Figure 3-90 for the location of **A6A10R88**.

Band D, 12.5 to 18.6 GHz

115. On the spectrum analyzer, key in **2-22 GHz**, (SHIFT) **PRESEL PEAK** = , (SHIFT) TRACE A **MAX HOLD** ^b. Set the spectrum analyzer controls as follows:

START FREQ	12.5 GHz
STOP FREQ	18.6 GHz
RES BW3 MHz
REFERENCE LEVEL	-7 dBm
LOG SCALE	10 dB/DIV
SWEEP TIME	500 ms

116. On the synthesized sweeper, key in **CW** 15.0 GHz.

Note

The POWER LEVEL of the synthesized sweeper should still be leveled to a calibrated -10.00 dBm at 100 MHz at the spectrum analyzer RF INPUT from step 55.

117. Adjust 22-turn (IF Offset) potentiometer **A6A12R83** D and 17-turn (YTX Bias) potentiometer **A6A10R12** VD for maximum signal amplitude at 15.0 GHz on the spectrum analyzer display. See Figure 3-90 for the locations of **A6A12R83** D and **A6A10R15** VD.

118. On the spectrum analyzer, key in **MARKER** **NORMAL**, **MARKER** **PEAKSEARCH** to position a marker at the peak of

2 1. Frequency Response Adjustments

the displayed 15.0 GHz signal. Adjust 17-turn (Band D Step Gain) potentiometer A6A10R27 GD as necessary to adjust the amplitude of the displayed 15.0 GHz marker to -10.00 dBm f0.10 dB. Adjust A6A10R27 GD counterclockwise to increase the signal level, and clockwise to decrease the signal level. If A6A10R27 GD does not have sufficient range, adjust the amplitude of the displayed 15.0 GHz marker as close as possible to -10.00 dBm. See Figure 3-90 for the location of A6A10R27 GD.

119. On the spectrum analyzer, key in LOG SCALE (ENTER dB/DIV) 2 dB, MARKER (NORMAL).
120. Readjust 22-turn (IF Offset) potentiometer A6A12R83 D as necessary to maximize the amplitude of the 15.0 GHz signal on the spectrum analyzer display.
121. Set the synthesized sweeper controls as follows:

START FREQ	12.5 GHz
STOP FREQ	18.6 GHz
RF	on
LEVELING	XTAL
SWEEP TIME	30 ms
SWEEP	CONT
122. On the spectrum analyzer, key in TRACE A (CLEAR-WRITE), (SWEEP TIME) 2s, MARKER (OFF), (HOLD). As the spectrum analyzer completes each sweep, a series of approximately 22 new responses should be displayed, as shown in Figure 3-98. The peaks of these responses coarsely outline the spectrum analyzer frequency response.
123. Gradually adjust (Band D Lower Segment) A6A11R57 D1 and (Band D Upper Segment) A6A11R75 D2 for maximum flatness of the displayed signal responses. The adjustments are interactive, with A6A11R57 D1 having the most effect on the level of the displayed signals below mid-band (approximately 15.5 GHz), and A6A11R75 D2 having the most effect on the level of the displayed signals above mid-band. Adjust A6A11R57 D1 counterclockwise to increase the level of the displayed signal responses below mid-band. Adjust A6A11R75 D2 clockwise to increase the level of the displayed signal responses above mid-band. See Figure 3-90 for the locations of A6A11R57 D1 and A6A11R75 D2.

Note

If the displayed signals at the high end of the band drop off by more than 2-3 dB, center A6A11R75 D2 and proceed to step 125.

124. On the spectrum analyzer, key in (SWEEP TIME) 5s, LOG SCALE (ENTER dB/DIV) 1 dB, TRACE B [VIEW], (SAVE) 4, (SWEEP TIME) 2s, TRACE B (BLANK), (HOLD).
125. Readjust 17-turn (YTX Diode Bias) potentiometer A6A10R12 VD to maximize the overall level of the displayed signal responses from 12.5 GHz to 18.6 GHz on the spectrum analyzer display. Then, adjust A6A10R12 VD clockwise until signal responses at

2 1. Frequency Response Adjustments

the high end of the band drop in amplitude by approximately 0.75 dB.

126. Readjust 22-turn (IF Offset) potentiometer A6A12R83 D as necessary to maximize the overall level of the displayed signal responses from 12.5 GHz to 18.6 GHz on the spectrum analyzer display. If the displayed signal responses peak at widely different settings of A6A12R83 D, perform the following steps:
 - a. Adjust 22-turn (YTX Linearity) potentiometers A6A10R41 LB2, A6A10R42 LB3, A6A10R70 LB4, A6A610R34 LR2, A6A10R37 LR3, and A6A10R76 LR4 fully counterclockwise if they have not already been so adjusted; do not readjust A6A12R40 LB1 or A6A10R31 LR1.
 - b. Readjust 22-turn (IF Offset) potentiometer A6A12R83 D as necessary to maximize the overall level of the displayed signal responses at the low end of the band.
 - c. On the spectrum analyzer, key in MARKER **NORMAL** and position the marker at the point in the band where the signal responses begin to fall off from their maximum value.
 - d. Adjust 22-turn (YTX Linearity) potentiometer A6A10R41 LB2 clockwise until the displayed signal responses at the high end of the band begin to drop. Continue to adjust A6A10R41 LB2 until the rolloff point aligns with the position of the marker. See Figure 3-90 for the location of A6A10R41 LB2, A6A10R42 LB3, A6A10R34 LR2 and A6A10R37 LR3.
 - e. Readjust 22-turn (YTX Linearity) potentiometer A6A10R34 LR2 clockwise to maximize the displayed signal responses for approximately 3 divisions to the right of the marker.
 - f. On the spectrum analyzer, key in MARKER **NORMAL** and position the marker at the point in the band where the signal responses begin to fall off from their maximum value.
 - g. Readjust 22-turn (YTX Linearity) potentiometer A6A10R42 LB3 clockwise until the displayed signal responses at the high end of the band begin to drop. Continue to adjust A6A10R42 LB3 until the rolloff point aligns with the position of the marker.
 - h. Readjust 22-turn (YTX Linearity) potentiometer A6A10R37 LR3 clockwise to maximize the displayed signal responses at the high end of the band.
 - i. Readjust A6A12R83 D, A6A10R34 LR2, and A6A10R37 LR3 as necessary to maximize the displayed signal responses from 12.5 GHz to 18.6 GHz on the spectrum analyzer display.
127. Gradually readjust (Band D Lower Segment) A6A11R57 D1 and (Band D Upper Segment) A6A11R75 D2 as necessary for maximum flatness of the displayed signal responses.
128. On the spectrum analyzer, key in SWEEP **SINGLE**, **ISWEEP TIME** 150s, TRACE A **BLANK**, TRACE B **MAX HOLD**, **SAVE** 6, TRACE B **CLEAR-WRITE**, **SAVE** 5, **HOLD**.
129. Press SWEEP **SINGLE** on the spectrum analyzer and wait for the sweep to complete (150 seconds) and the SWEEP LED to turn off. As the spectrum analyzer tunes from 12.5 GHz to 18.6 GHz, the spectrum analyzer frequency response should be displayed as TRACE B.

21. Frequency Response Adjustments

130. On the spectrum analyzer, key in **RECALL** 4, (**HOLD**) and repeat steps 126 through 128 as necessary.
131. On the spectrum analyzer, key in **RECALL** 5 and wait for the sweep to complete (150 seconds) and the SWEEP LED to turn Off.
132. On the spectrum analyzer, key in **RECALL** 4, **SHIFT** **GHz** / and use the DATA knob to gradually change the PRESELECTOR DAC setting from 32, maximizing the level of the TRACE A displayed signal responses at the lowest point on the TRACE B waveform. Note the PRESELECTOR DAC setting.
133. On the spectrum analyzer, key in **RECALL** 6, **SHIFT** **GHz** / and enter in the PRESELECTOR DAC setting from step 132. Press SWEEP (**SINGLE**) and wait for the sweep to complete (150 seconds) and the SWEEP LED to turn off.
134. Repeat steps 132 and 133 until the level of the lowest point on the TRACE B waveform does not change. Repeat step 133 with a PRESELECTOR DAC setting of 30 and 34.
135. On the spectrum analyzer, key in TRACE B (VIEW), MARKER **NORMAL** and use the DATA knob to position a marker on the lowest point on the TRACE B waveform. Then, press MARKER **Δ**, MARKER **PEAK SEARCH** to position a second marker on the highest point on the TRACE B waveform. Note the total peak-to-peak deviation of the displayed trace.
Band D total peak-to-peak deviation: _____ dB
136. On the spectrum analyzer, press MARKER **NORMAL** and note the frequency of the highest point on the TRACE B waveform.
Band D highest point: _____ GHz
137. Repeat steps 130 through 136 as necessary until the total peak-to-peak deviation of the TRACE B waveform is less than 4.40 dB. See the TRACE B reference waveform to indicate which portions of the frequency response waveform require relative adjustment.
138. On the spectrum analyzer, key in **RECALL** 4, **HOLD**.
139. On the synthesized sweeper, press **CW** and enter the frequency recorded in step 136, positioning the displayed TRACE A signal response at the highest point on the TRACE B waveform.

Note

The RF Section front-panel AMPTD CAL control should still be set to the approximate center of its adjustment range from step 26.

140. On the spectrum analyzer, key in MARKER **NORMAL**, MARKER **PEAK SEARCH** to position a marker at the peak of the displayed TRACE A signal response. Adjust 17-turn (Band D Step Gain) potentiometer A6A10R27 GD to adjust the amplitude of the marker to -10.00 dBm + (1/2 of Band D total peak-to-peak deviation) f0.01 dB. Adjust A6A10R27 GD counterclockwise to increase the signal level, and clockwise to decrease the signal level.

2 1. Frequency Response Adjustments

Note

If A6A10 Miscellaneous Bias/Relay Driver Assembly is HP P/N 85660-60322 (HP 85660A/B RF Sections with serial number prefix 2747A or above), and A6A10R27 GD does not have sufficient range, change the value of factory-select component A6A10R88. Increase the value of A6A10R89 to decrease the signal level, and decrease the value of A6A10R89 to increase the signal level. See Table 3-3 for the acceptable range of values for A6A10R89, and Table 3-4 for HP part numbers. See Figure 3-90 for the location of A6A10R89.

Band E, 18.6 GHz to 22 GHz

141. On the spectrum analyzer, key in **2-22 GHz**, **SHIFT** **PRESEL PEAK** =, **SHIFT** **TRACE A** **MAX HOLD**^b. Set the spectrum analyzer controls as follows:

START FREQ	18.6 GHz
STOP FREQ	22 GHz
RES BW	3 MHz
REFERENCE LEVEL	-7 dBm
LOG SCALE	10 dB/DIV
SWEEP TIME	500 ms

142. On the synthesized sweeper, key in **CW** 20.0 GHz.

Note

The POWER LEVEL of the synthesized sweeper should still be leveled to a calibrated -10.00 dBm at 100 MHz at the spectrum analyzer RF INPUT from step 55.

143. Adjust 22-turn (IF Offset) potentiometer A6A12R82 E and 17-turn (YTX Bias) potentiometer A6A10R9 VE for maximum signal amplitude at 20.0 GHz on the spectrum analyzer display. See Figure 3-90 for the locations of A6A12R82 E and A6A10R95 VE.

144. On the spectrum analyzer, key in MARKER **NORMAL**, MARKER **PEAK SEARCH** to position a marker at the peak of the displayed 20.0 GHz signal. Adjust Ill-turn (Band E Step Gain) potentiometer A6A10R29 GE as necessary to adjust the amplitude of the displayed 20.0 GHz marker to -10.00 dBm fO.10 dB. Adjust A6A10R29 GE counterclockwise to increase the signal level, and clockwise to decrease the signal level. If A6A10R29 GE does not have sufficient range, adjust the amplitude of the displayed 20.0 GHz marker as close as possible to -10.00 dBm. See Figure 3-90 for the location of A6A10R29 GE.

145. On the spectrum analyzer, key in LOG SCALE **CENTER dB/DIV** 2 dB, MARKER **NORMAL**.

146. Readjust 22-turn (IF Offset) potentiometer A6A12R82 E as necessary to maximize the amplitude of the 20.0 GHz signal on the spectrum analyzer display.

147. Set the synthesized sweeper controls as follows:

START FREQ	18.6 GHz
STOP FREQ	22.0 GHz
RF	on
LEVELING	XTAL

2 1. Frequency Response Adjustments

SWEEP TIME30 ms
SWEEP CONT

148. On the spectrum analyzer, key in TRACE A CLEAR-WRITE, SWEEP TIME 2s, MARKER (OFF), HOLD. As the spectrum analyzer completes each sweep, a series of approximately 23 new responses should be displayed. The peaks of these responses coarsely outline the spectrum analyzer frequency response.
149. Gradually adjust (Band E Lower Segment) A6A11R60 E1 and (Band E Upper Segment) A6A11R78 E2 for maximum flatness of the displayed signal responses. The adjustments are interactive, with A6A11R60 E1 having the most effect on the level of the displayed signals below mid-band (approximately 20.3 GHz), and A6A11R78 E2 having the most effect on the level of the displayed signals above mid-band. Adjust A6A11R60 E1 counterclockwise to increase the level of the displayed signal responses below mid-band. Adjust A6A11R78 E2 clockwise to increase the level of the displayed signal responses above mid-band. See Figure 3-90 for the locations of A6A11R60 E1 and A6A11R78 E2.

Note

If the displayed signals at the high end of the band drop off by more than 3-4 dB, center A6A11R78 E2 and proceed to step 150.

150. On the spectrum analyzer, key in SWEEP TIME 5s, LOG SCALE CENTER dB/DIV 1 dB, TRACE B (VIEW), SAVE 4, SWEEP TIME 2s, TRACE B BLANK, HOLD.
151. Readjust 17-turn (YTX Diode Bias) potentiometer A6A10R95 VE to maximize the overall level of the displayed signal responses from 18.6 GHz to 22.0 GHz on the spectrum analyzer display. Then, adjust A6A10R95 VE clockwise until signal responses at the high end of the band drop in amplitude by approximately 1.5 dB.
152. Readjust 22-turn (IF Offset) potentiometer A6A12R82 E as necessary to maximize the overall level of the displayed signal responses from 18.6 GHz to 22.0 GHz on the spectrum analyzer display. If the displayed signal responses peak at widely different settings of A6A12R82 E, perform the following steps:
 - a. Adjust 22-turn (YTX Linearity) potentiometers A6A10R70 LB4 and A6A10R76 LR4 fully counterclockwise if they have not already been so adjusted; do not readjust A6A12R40 LB1, A6A10R41 LB2, A6A10R42 LB3, A6A10R31 LR1, A6A10R34 LR2, or A6A10R37 LR3.
 - b. Readjust 22-turn (IF Offset) potentiometer A6A12R82 E as necessary to maximize the overall level of the displayed signal responses at the low end of the band.
 - c. On the spectrum analyzer, key in MARKER NORMAL and position the marker at the point in the band where the signal responses begin to fall off from their maximum value.
 - d. Readjust 22-turn (YTX Linearity) potentiometer A6A10R70 LB4 clockwise until the displayed signal responses at the high end of the band begin to drop. Continue to adjust A6A10R70 LB4 until the rolloff point aligns with the position of the

2 1. Frequency Response Adjustments

- marker. See Figure 3-90 for the locations of A6A10R70 LB4 and A6A10R76 LR4.
- e. Readjust 22-turn (YTX Linearity) potentiometer A6A10R76 LR4 clockwise to maximize the displayed signal responses at the high end of the band.
 - f. Readjust A6A12R82 E and A6A10R76 LR4 as necessary to maximize the displayed signal responses from 18.6 GHz to 22.0 GHz on the spectrum analyzer display.
153. Gradually readjust (Band E Lower Segment) A6A11R60 E1 and (Band E Upper Segment) A6A11R78 E2 as necessary for maximum flatness of the displayed signal responses.
 154. On the spectrum analyzer, key in SWEEP **[SINGLE]**, **[SWEEP TIME]** 150s, TRACE A **[BLANK]**, TRACE B **[MAX HOLD]**, **[SAVE]** 6, TRACE B **[CLEAR-WRITE]**, **[SAVE]** 5, **[HOLD]**.
 155. Press SWEEP **[SINGLE]** on the spectrum analyzer and wait for the sweep to complete (150 seconds) and the SWEEP LED to turn off. As the spectrum analyzer tunes from 18.6 GHz to 22.0 GHz, the spectrum analyzer frequency response should be displayed as TRACE B.
 156. On the spectrum analyzer, key in **[RECALL]** 4, **[HOLD]** and repeat steps 152 through 154 as necessary.
 157. On the spectrum analyzer, key in **[RECALL]** 5 and wait for the sweep to complete (150 seconds) and the SWEEP LED to turn Off.
 158. On the spectrum analyzer, key in **[RECALL]** 4, **[SHIFT]** **[GHz]** / and use the DATA knob to gradually change the PRESELECTOR DAC setting from 32, maximizing the level of the TRACE A displayed signal responses at the lowest point on the TRACE B waveform. Note the PRESELECTOR DAC setting.
 159. On the spectrum analyzer, key in **[RECALL]** 6, **[SHIFT]** **[GHz]** / and enter in the PRESELECTOR DAC setting from step 158. Press SWEEP **[SINGLE]** and wait for the sweep to complete (150 seconds) and the SWEEP LED to turn off.
 160. Repeat steps 158 and 159 until the level of the lowest point on the TRACE B waveform does not change. Repeat step 159 with a PRESELECTOR DAC value of 30 and 34.
 161. On the spectrum analyzer, key in TRACE B (VIEW), MARKER **[NORMAL]** and use the DATA knob to position a marker on the lowest point on the TRACE B waveform. Then, press MARKER **[Δ]**, MARKER **[PEAK SEARCH]** to position a second marker on the highest point on the TRACE B waveform. Note the total peak-to-peak deviation of the displayed trace.

Band E total peak-to-peak deviation: _____ dB
 162. On the spectrum analyzer, press MARKER **[NORMAL]** and note the frequency of the highest point on the TRACE B waveform.

Band E highest point: _____ GHz
 163. Repeat steps 156 through 162 if necessary until the total peak-to-peak deviation of the TRACE B waveform is less than

21. Frequency Response Adjustments

4.40 dB from 18.6 GHz to 20.0 GHz, and 6.00 dB from 20.0 GHz to 22.0 GHz. See the TRACE B reference waveform to indicate which portions of the frequency response waveform require relative adjustment.

164. On the spectrum analyzer, key in **RECALL** 4, (HOLD).
165. On the synthesized sweeper, press **CW** and enter the frequency recorded in step 163, positioning the displayed TRACE A signal response at the highest point on the TRACE B waveform.

Note

The RF Section front-panel AMPTD CAL control should still be set to the approximate center of its adjustment range from step 26.

166. On the spectrum analyzer, key in **MARKER** **NORMAL**, **MARKER** **PEAK SEARCH** to position a marker at the peak of the displayed TRACE A signal response. Adjust **17-turn** (Band E Step Gain) potentiometer **A6A10R29** GE to adjust the amplitude of the marker to $-10.00 \text{ dBm} + (1/2 \text{ of Band E total peak-to-peak deviation}) \pm 0.01 \text{ dB}$. Adjust **A6A10R29** GE counterclockwise to increase the signal level, and clockwise to decrease the signal level.

Note

IF **A6A10** Miscellaneous Bias/Relay Driver Assembly is HP P/N 85660-60322 (HP 85660A/B RF Sections with serial number prefix 2747A or above), and **A6A10R29** GE does not have sufficient range, change the value of factory-select component **A6A10R90**. Increase the value of **A6A10R90** to decrease the signal level, and decrease the value of **A6A10R90** to increase the signal level. See Table 3-3 for the acceptable range of values for **A6A10R90**, and Table 3-4 for HP part numbers. See Figure 3-90 for the location of **A6A10R90**.

YTX Delay Compensation, 2.0 GHz – 22 GHz

Note

YTX Delay Compensation adjustments **A6A12R25** D2, **A6A12R24** D3, and factory-select components **A6A12C1**, **A6A12C2**, **A6A12C11**, and **A6A12C23** affect YTX/YTO dynamic tracking in all preselected frequency bands (Bands B, C, D, and E, 2 GHz – 22 GHz) for **SWEEP TIME** settings faster than approximately $1s/\text{frequency band}$.

Note

YTX Delay Compensation adjustment **A6A12R26** D1 is used in HP 85660A RF Sections only, and has no effect in HP 85660B RF Sections (**A6A12C3** is not installed in the HP 85660B). YTX Delay Compensation adjustments **A6A12R25** D2 and **A6A12R24** D3 have very little effect in HP 85660B RF Sections, and are usually set near the counterclockwise end of their adjustment range.

167. On the spectrum analyzer, key in **2-22 GHz**, **SHIFT** **PRESEL PEAK** =, **SHIFT** TRACE A **MAX HOLD** b r u m a n a l y z e r controls as follows:

START FREQ 12.5 GHz

2 1. Frequency Response Adjustments

STOP FREQ 18.6 GHz
 RES BW 3 MHz
 REFERENCE LEVEL -7 dBm
 LOG SCALE 5 dB/DIV
 SWEEP TIME 1 sec

168. On the synthesized sweeper, key in **CW** 13.1 GHz.

Note

The POWER LEVEL of the synthesized sweeper should still be leveled to a calibrated -10.00 dBm at 100 MHz at the spectrum analyzer RF INPUT from step 55.

169. If the A11A3 YTO, A6A8 YTX, or A6A12 YTX Driver Assembly have been repaired or replaced, adjust (YTX Delay Compensation) potentiometers A6A12R25 D2 and A6A12R24 D3 45° clockwise from fully counterclockwise.
170. On the spectrum analyzer, key in MARKER **PEAK SEARCH**, **SHIFT** **GHz** /.
171. On the spectrum analyzer, press **PRESEL PEAK** and wait for the preselector peaking routine to complete. Record the Preselector DAC value in the 1 second SWEEP TIME column of Table 3-15.

Table 3-15.
Preselector Delay Compensation DAC Values

Trial Number	Preselector DAC Value	
	1s SWEEP TIME	AUTO SWEEP TIME
1		
2		
3		
4		
5		
Average Value		

172. Repeat step 171 to record four additional Preselector DAC value entries in the 1s SWEEP TIME column of Table 3-15.
173. On the spectrum analyzer, key in SWEEP TIME **AUTO**, MARKER **PEAK SEARCH**.
174. On the spectrum analyzer, press **PRESEL PEAK** and wait for the preselector peaking routine to complete. Record the Preselector DAC value in the **AUTO** SWEEP TIME column of Table 3-15.
175. Repeat step 174 to record four additional Preselector DAC value entries in the **AUTO** SWEEP TIME column of Table 3-15.
176. Calculate the average Preselector DAC value for the 1 second SWEEP TIME and **AUTO** SWEEP TIME settings, and enter them in Table 3-15. Subtract the average Preselector DAC value for 1 second SWEEP TIME from the value for **AUTO** SWEEP TIME, and record the difference in the following line:

preselector DAC value difference: _____

2 1. Frequency Response Adjustments

177. If the Preselector DAC value difference recorded in step 176 is greater than 0.5, remove the A6A12 YTX Driver Assembly from the RF Section and determine the current values of factory-select components A6A12C1, A6A12C2, A6A12C11, and A6A12C23. Then, refer to Table 3-16 to determine the final capacitor values to install for A6A12C1, A6A12C2, A6A12C11, and A6A12C23. Find the line in the table that corresponds to the current values of the four factory-select capacitors (A6A12C1 and A6A12C2 are in parallel, and A6A12C11 and A6A12C23 are in parallel). Add the difference recorded in step 176 to the line number corresponding to the current values to determine the line number of the final capacitor values to install for A6A12C1, A6A12C2, A6A12C11, and A6A12C23. See Table 3-4 for HP part numbers. See Figure 3-90 for the locations of A6A12C1, A6A12C2, A6A12C11, and A6A12C23.

For example, if the average Preselector DAC value for [AUTO] SWEEP TIME is 35.4 and the average value for [SWEEP TIME] is 32.0, the difference recorded in step 177 is +3.4. Assume that the currently installed value of A6A12C1 is 0.33 μF , the value of A6A12C11 is 0.22 μF , and that A6A12C2, A6A12C3, and A6A12C23 are not installed. These values correspond to line 0 of Table 3-16. The final capacitor values are listed in line 3, determined by adding the difference of +3.4 to line number 0. The value of A6A12C1 is correct already, and A6A12C11 is changed to a 0.1 μF capacitor.

Table 3-16.
A6A12 YTX Driver Assembly Factory-Select
Capacitor Values

Line	Capacitor Values (μF)				
	A6A12C1	A6A12C2	A6A12C11	A6A12C23	A6A12C3
- 8	0.33	0.22	0.22	0.33	open
- 7	0.33	0.22	0.22	0.22	open
- 6	0.33	0.22	0.22	0.22	open
- 5	0.33	open	0.22	0.33	open
- 4	0.33	open	0.22	0.33	open
- 3	0.33	open	0.22	0.22	open
- 2	0.33	open	0.22	0.15	open
- 1	0.33	open	0.22	0.10	open
0	0.33	open	0.22	open	open
+ 1	0.33	open	0.22	open	open
+ 2	0.33	open	0.15	open	open
+ 3	0.33	open	0.10	open	open
+ 4	0.15	open	0.22	open	open
+ 5	0.33	open	open	open	open
+ 6	open	open	0.22	open	open
+ 7	open	open	0.22	open	open
+ 8	open	open	0.15	open	open

21. Frequency Response Adjustments

178. If the factory-select capacitor values listed in Line 0 are installed, the LINE column corresponds to the average Preselector DAC value difference of step 177
179. On the spectrum analyzer, key in **[SHIFT] [PRESEL PEAK]** =.

External Mixing – 18.6 GHz to 325 GHz

180. Connect the low-loss microwave test cable to the synthesized sweeper RF OUTPUT using an APC 3.5 (f) to APC 3.5 (f) adapter. See Figure 3-95. Connect the power meter/power sensor to the opposite end of the test cable using a Type N (f) to APC 3.5 (f) adapter.

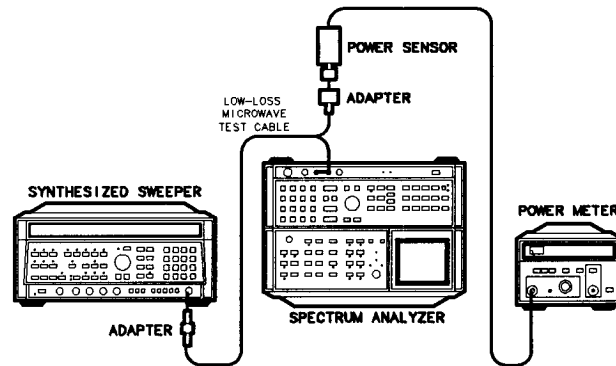

Figure 3-99.
Frequency Response Adjustments Setup (18.6 to 325 GHz)

181. Press **[2-22 GHz]** on the synthesized sweeper. Set the controls of the synthesized sweeper as follows:

CW	321.4 MHz
POWER LEVEL	-20.0 dBm
RF	on
LEVELING	INT
182. On the synthesized sweeper, press **[POWER LEVEL]** and adjust the ENTRY knob for a power meter indication of $-20.00 \text{ dBm} \pm 0.03 \text{ dB}$ at 321.4 MHz.
183. On the synthesized sweeper, key in **[SHIFT] [ATTEN]** -10 dB to decrease the output power by 10.0 dB.
184. Disconnect the jumper cable from between the spectrum analyzer front panel 321.4 MHz IF INPUT and IF OUTPUT connectors.
185. Disconnect the low-loss microwave test cable from the power meter/power sensor, and connect the test cable to the spectrum analyzer front panel 321.4 MHz IF INPUT connector.
186. On the spectrum analyzer, key in **[2-22 GHz]**, **[SHIFT] [↑]**^U, 6 Hz, **[SHIFT] [REFERENCE LEVEL]**^Z 0 dB. Set the spectrum analyzer controls as follows:

RES BW	1 MHz
REFERENCE LEVEL	+3 dBm

2 1. Frequency Response Adjustments

LOG SCALE 1 dB/DIV

187. Press MARKER **(NORMAL)** and adjust (IF Step Gain) potentiometer **A6A10R81** GF for a marker indication of 0.00 dBm fO.O1 dB.

Note

If **A6A10** Miscellaneous Bias/Relay Driver Assembly is HP P/N 85660-60322 (HP 85660A/B RF Sections with serial number prefix 2747A or above), and **A6A10R81** GF does not have sufficient range, change the value of factory-select component **A6A10R91**. Increase the value of **A6A10R91** to decrease the signal level, and decrease the value of **A6A10R91** to increase the signal level. See **Table 3-3** for the acceptable range of values for **A6A10R91**, and **Table 3-4** for HP part numbers. See **Figure 3-90** for the location of **A6A10R91**.

188. Disconnect the low-loss microwave test cable from the spectrum analyzer front panel 321.4 MHz IF INPUT connector. Reconnect the jumper cable between the spectrum analyzer front panel 32 1.4 MHz IF INPUT and IF OUTPUT connectors.
189. On the spectrum analyzer, key in **(SHIFT)** **(↑)** ^U, 6 Hz, **(SHIFT)** **(REFERENCE LEVEL)** ^Z -12 dBm.
190. In the RF Section, disconnect cable 84 (gray/yellow) from **A6A12J1** and cable 82 (gray/red) from **A6A12J2**. Replace the cover to the A6 RF Module, and then reconnect cable 84 (gray/yellow) to **A6A12J1** and cable 82 (gray/red) to **A6A12J2**.
191. Remove the jumper between **A12TP2** and **A12TP3** (LOCK INDICATOR DISABLE) on the A12 Front Panel Interface Assembly in the RF Section.
192. Replace the RF Section bottom cover.

22. Analog-To-Digital Converter Adjustments

Reference A3A8 Analog-to-Digital Converter

Description The Analog-to-Digital Ramp Converter is adjusted at zero and full-scale by injecting a 0 V dc input and + 10 V dc input and adjusting the OFFS and GAIN controls until the ramp output at A3A8TP11 toggles high to low. This sets the horizontal end points for the CRT trace display; when the sweep ramp input is at 0 V dc (the left graticule edge), trace position 1 is set, and when the sweep ramp input is at + 10 V dc (the right graticule edge), trace position 1000 is set.

This procedure requires a + 10 V dc source which is stable and noise-free. A simple supply circuit which can be built with common components is illustrated in Figure 3-108. If these components are unavailable, the alternate procedure provided below (using only the digital voltmeter) can then be used.

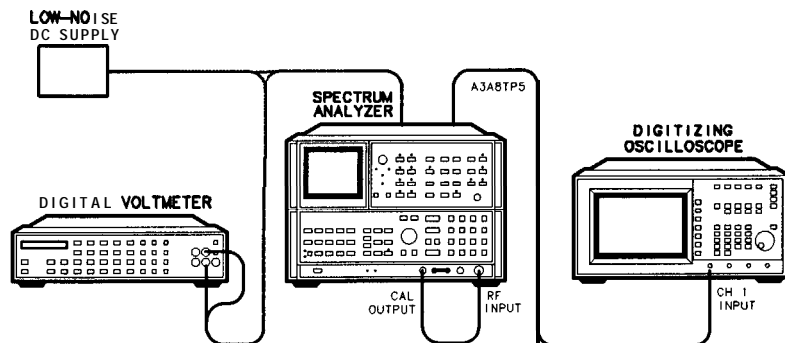

Figure 3-100. Analog-To-Digital Converter Adjustments Setup

Equipment	Oscilloscope	HP 54501A
	Digital Voltmeter	HP 3456A
	Low-Noise DC Supply (Optional)	See Figure 3-108
	10:1 Divider Probe, 10 M Ω /7.5 pF	HP 10432A

- Procedure**
1. Position spectrum analyzer upright as shown in Figure 3-100 and remove IF-Display Section top cover.
 2. Set spectrum analyzer LINE switch to ON and press **2-22 GHz**.
 3. Procedure using Low-Noise DC Supply is illustrated in Figure 3-108.
 - a. Key in **BLANK** TRACE A and SWEEP **SINGLE**.
 - b. Disconnect cable 0 (black) from sweep ramp input A3A8J1.
 - c. Short A3A8TP4 to A3A8TP5 or connect SMB snap-on short to A3A8J1.

22. Analog-To-Digital Converter Adjustments

- d. Connect the oscilloscope channel 1, 10: 1 probe to A3A8TP11 and ground the probe ground to the A3 section's card cage.
- e. Set the oscilloscope settings as follows:

Press **CHAN**

Channel 1 on
probe 10:1
amplitude scale 1 V/div
offset 2 V
coupling dc

Press (TRIG)

EDGE TRIGGER auto, edge
source Channel 1

Press **TIME BASE**

time scale 5 μ s/div

Press Display

connect dots on

Press **SHOW**

- f. Adjust A3A8R6 OFFS for a square wave displayed on the oscilloscope. The square wave should be approximately 4 V_{pp}. See Figure 3-101 for location of adjustment.
- g. Remove short from A3A8TP4 and A3A8TP5 or disconnect the SMB snap-on short from A3A8J1.
- h. Press **0-2.5 GHz**.
- i. Press MARKER **NORMAL**, 1498 (MHz), and **SHIFT SINGLE** ^u.
- j. Connect DVM to A3A8TP5 and ground to A3A8TP4. Set DVM for V dc.
- k. Connect output of the Low-Noise DC Supply to A3A8J1. Adjust the Low-Noise DC Supply for DVM indication of + 10.000 \pm .001V dc.
- l. Adjust A3A8R5 GAIN for a square wave displayed on the oscilloscope. The square wave should be approximately 4 V_{pp}. See Figure 3-101 for location of adjustment.
- m. Disconnect low-noise dc supply from A3A8J1. Reconnect 0 cable to A3A8J 1.

22. Analog-To-Digital Converter Adjustments

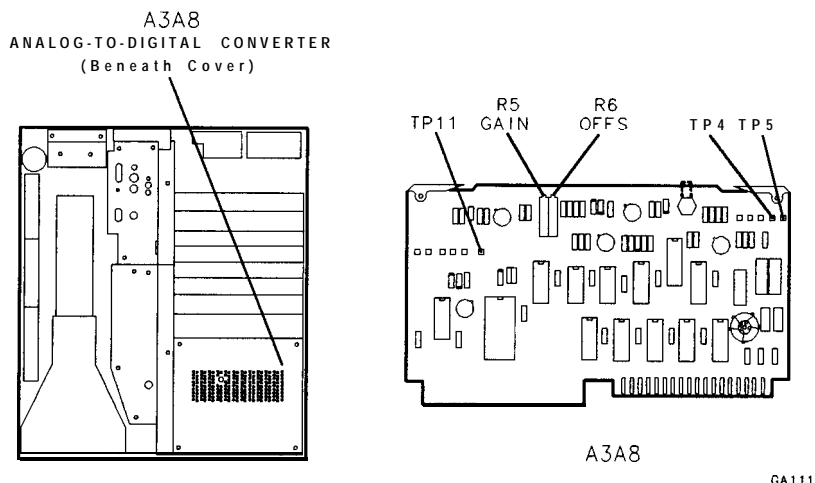

Figure 3-101.
Location of Analog-to-Digital Converter Adjustments

Alternate Procedure 4 . Procedure without using Low-Noise DC Supply:

- a. Press **2-22 GHz**.
- b. Key in TRACE A **BLANK** and SWEEP **SINGLE**.
- c. Disconnect cable 0 (black) from sweep ramp input A3A8J1.
- d. Short A3A8TP4 to A3A8TP5 or connect SMB snap-on short to A3A8J1.
- e. Connect DVM to A3A8TP11 and ground to A3A8TP4. Set DVM for V ac.
- f. Adjust A3A8R6 OFFS until the level at A3A8TP11 is at a maximum ac voltage as indicated by the DVM (approximately 2.0 V ac). See Figure 3-101 for location of adjustment.
- g. Remove short from A3A8TP4 and A3A8TP5. Reconnect cable 0 (black) to A3A8J1.
- h. Press **0-2.5 GHz**.
- i. Connect DVM to A3A8TP5 and ground to A3A8TP4. Set DVM for V dc.
- j. Press SWEEP **SINGLE**. Note DVM reading at end of the sweep. The voltage will begin to drift immediately after the sweep ends. Therefore, the first indication after the sweep ends is the valid indication. It may be helpful to press **SINGLE** several times to ensure a valid indication at the end of the sweep.
- k. If DVM indication is $+ 10.020 \pm 0.005$ V dc at the end of the sweep, no further adjustment is necessary. Otherwise, adjust A3A8R5 GAIN and repeat step until the voltage at the end of the sweep is $+ 10.020 \pm 0.005$ V dc.

23. Track and Hold Adjustments

Reference A3A9 Track and Hold

Description The CAL OUTPUT signal is connected to the RF INPUT. The spectrum analyzer is placed in zero frequency span to produce a dc level output from the IF-Video section and this dc level is regulated by adjusting the reference level. The Offsets and Gains on the Track and Hold assembly are adjusted for proper levels using a DVM.

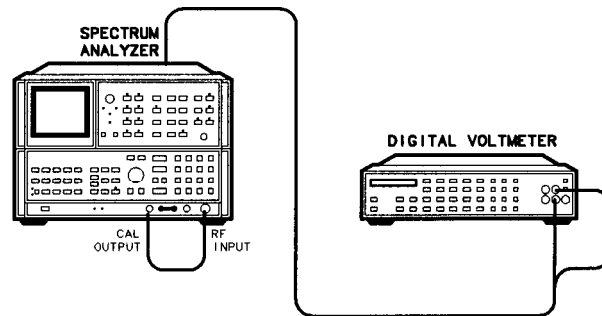

Figure 3-102. Track and Hold Adjustments Setup

Equipment Digital Voltmeter (DVM) HP 3456A

- Procedure**
1. Place spectrum analyzer upright as shown in Figure 3-102 with IF-Display Section top cover and A3 Digital Storage covers removed.
 2. Set spectrum analyzer LINE switch to ON and press **2.22 GHz**.
 3. Connect CAL OUTPUT to RF INPUT.
 4. Connect DVM to A3A9TP3 and ground to A3A9TP1.
 5. Key in **CENTER FREQUENCY** 100 MHz, **FREQUENCY SPAN** 0 Hz.
 6. Disconnect cable 7 (violet) from A4A1J1.
 7. Short A3A9TP1 to A3A9TP3, or use an SMB snap-on short to A3A9J1. DVM indication should be 0.000 f0.001 V dc.
 8. Key in **SINGLE**, TRACE A **CLEAR-WRITE**, MARKER **NORMAL**, MARKER **Δ**, SWEEP **CONT**, **SHIFT** TRACE A **BLANK**^e.
 9. Adjust A3A9R59 (T/H) OFS until MARKER A level indication as indicated by CRT annotation flickers back and forth between .00 and .10 dB. See Figure 3-103 for location of adjustment.

23. Track and Hold Adjustments

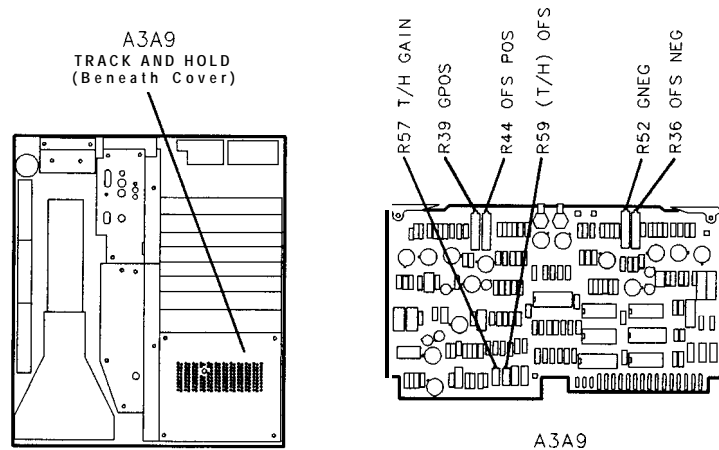

Figure 3-103. Location of Track and Hold Adjustments

10. Key in **SHIFT** TRACE A **MAX HOLD** ^b.
11. Adjust **A3A9R44** OFS POS until MARKER A level indication as indicated by CRT annotation flickers back and forth between .00 and .10 dB.
12. Key in **SHIFT** TRACE A (VIEW) ^d.
13. Adjust **A3A9R36** OFS NEG until MARKER A level indication as indicated by CRT annotation flickers back and forth between .00 and .10 dB.
14. Key in **SHIFT** TRACE A **BLANK** ^e.
15. Remove short from between **A3A9TP1** and **A3A9TP3** or remove the SMB short from **A3A9J1**. Reconnect cable 7 (violet) to **A4A1J1**.
16. Connect the DVM to **A4A1TP3**. Connect DVM's ground to the IF section's casting.
17. Press **REFERENCE LEVEL** and adjust DATA knob and front-panel AMPTD CAL adjust for a DVM indication of +2.000 f0.001 V dc at **A4A1TP3**.
18. Disconnect DVM from instrument.
19. Key in **SINGLE**, TRACE A **CLEAR-WRITE**, MARKER **NORMAL**, MARKER **Δ**, SWEEP **CONT**.
20. Adjust **A3A9R57** T/II GAIN for GAIN for MARKER A level indication as indicated by CRT annotation of 100 f0.1 dB.
21. Key in **SHIFT** TRACE A **MAX HOLD** ^b.
22. Adjust **A3A9R39** GPOS for MARKER A level indication as indicated by CRT annotation of 100 f0.1 dB.
23. Key in **SHIFT** TRACE A **VIEW** ^d.
24. Adjust **A3A9R52** GNEG for MARKER A level indication as indicated by CRT annotation of 100 ±0.1 dB.

23. Track and Hold Adjustments

25. Repeat steps 4 through 24 until no further adjustments are required.

24. Digital Storage Display Adjustments

Reference A3A 1 Trigger
A3A2 Intensity Control
A3A3 Line Generator

Description First, preliminary CRT graticule adjustments are performed to position the graticule on the CRT. These preliminary adjustments assume that repair has been performed on the associated circuitry. If no repair has been performed on the assemblies listed under REFERENCE, the preliminary adjustments are not necessary.

Next, the Sample and Hold Balance adjustments are performed. The horizontal and vertical Offset and Gain adjustments are performed, then the final CRT graticule adjustments are performed.

Last, the CRT annotation adjustments are performed to place the CRT annotation in proper location with respect to the CRT graticule.

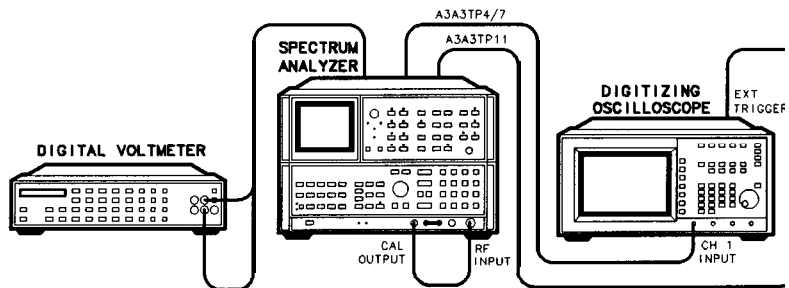

Figure 3-104. Digital Storage Display Adjustments Setup

Equipment

Digital Voltmeter (DVM)	HP 3456A
Digitizing Oscilloscope	HP 54501A
10: 1 Divider Probe, 10 MΩ/7.5 pF (2 required)	HP 10A32A

- Procedure**
1. Place spectrum analyzer upright as shown in Figure 3-104 with IF-Display Section top cover and A3 Digital Storage cover removed.
 2. Set spectrum analyzer LINE switch to ON and press **2-22 GHz**

24. Digital Storage Display Adjustments

Preliminary Graticule Adjustments

3. Press TRACE A **BLANK**.
4. Adjust A3A3R4 X GAIN and A3A3R5 Y GAIN to place graticule information completely on CRT. See Figure 3-105 for location of adjustment.
5. Adjust A3A2R12 LL THRESH fully clockwise. See Figure 3-105 for location of adjustment.

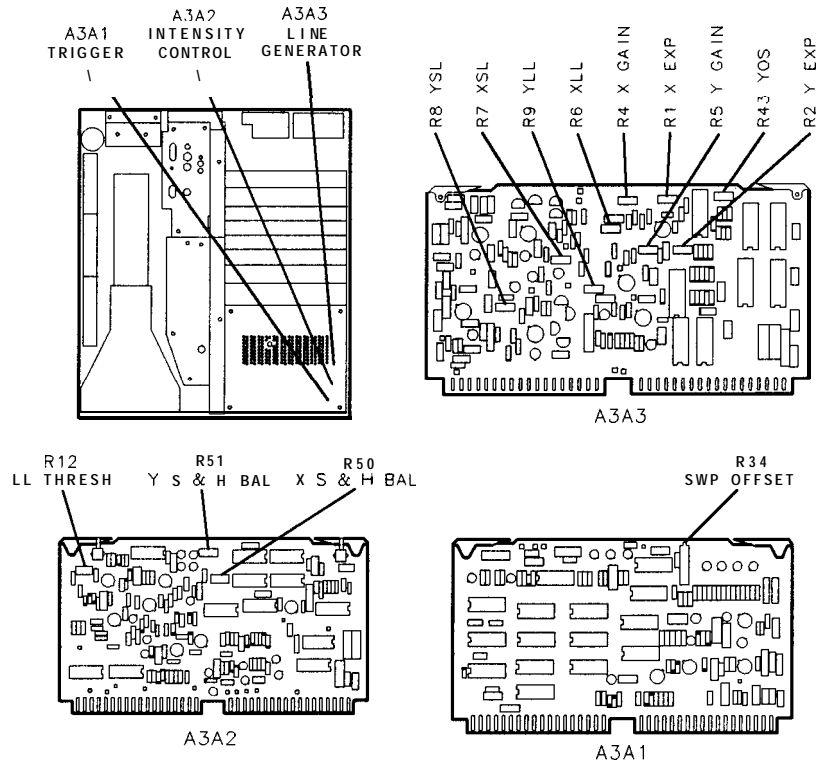

Figure 3-105.
Location of Digital Storage Display Adjustments

6. Adjust A3A3R6 XLL so that horizontal graticule lines just meet the vertical graticule lines at the left and right sides of the graticule. See Figure 3-105 for location of adjustment.
7. Adjust A3A3R9 YLL so that vertical graticule lines just meet the horizontal graticule lines at the top and bottom of the graticule. See Figure 3-105 for location of adjustment.
8. Repeat steps 6 and 7 until horizontal and vertical lines are adjusted so that they meet the edges of the graticule but do not overshoot.
9. Adjust A3A2R12 LL THRESH fully counterclockwise.
10. Adjust A3A3R7 XSL so that horizontal graticule lines just meet the vertical graticule lines at the left and right sides of the graticule.

24. Digital Storage Display Adjustments

11. Adjust A3A3R8 YSL so that the vertical graticule lines just meet the horizontal graticule lines at the top and bottom of the graticule.
12. Repeat steps 10 and 11 until horizontal and vertical graticule lines are adjusted so that they meet at the edges of the graticule but do not overshoot.

Sample and Hold Balance Adjustments

13. Set spectrum analyzer LINE switch to STANDBY.
14. Place A3A3 Line Generator on extender boards.
15. Set spectrum analyzer LINE switch to ON. Press **2-22 GHz**.
16. Key in (SHIFT) **0**^z (RECORDER LOWER LEFT) **0 Hz**. Press (SHIFT) **0**^l (RECORDER UPPER RIGHT) **1028 Hz**.
17. Set the oscilloscope controls as follows:

Press **CHAN**

Channel 1 on
 probe 10:1
 amplitude scale 50 mV/div
 offset 0 V
 coupling dc
 Channel 4 off
 probe 10:1
 amplitude scale 2 V/div
 offset 0 V
 coupling dc

Press (TRIG)

source Channel 4
 level 300 mV, edge

Press **TIME BASE**

time scale 500 ns/div
 delay -400 ns

Press **DISPLAY**

connect dots on

Press **SHOW**

18. Adjust A3A2R50 X S&H BAL for minimum dc offset between the level of the signal inside the two pulses to the signal level outside the two pulses. Figure 3-106 shows a properly adjusted waveform. Figure 3-107 shows the waveform before adjustment. Refer to Figure 3-105 for location of adjustment.

24. Digital Storage Display Adjustments

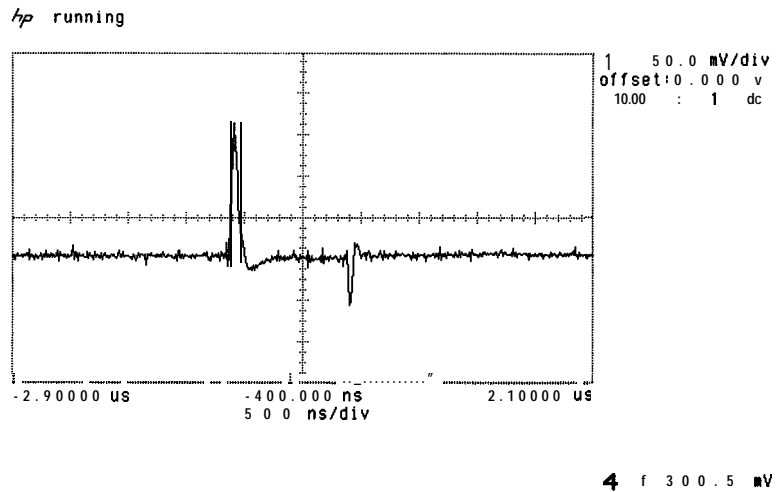

Figure 3-106. Sample and Hold Balance Adjustment Waveforms

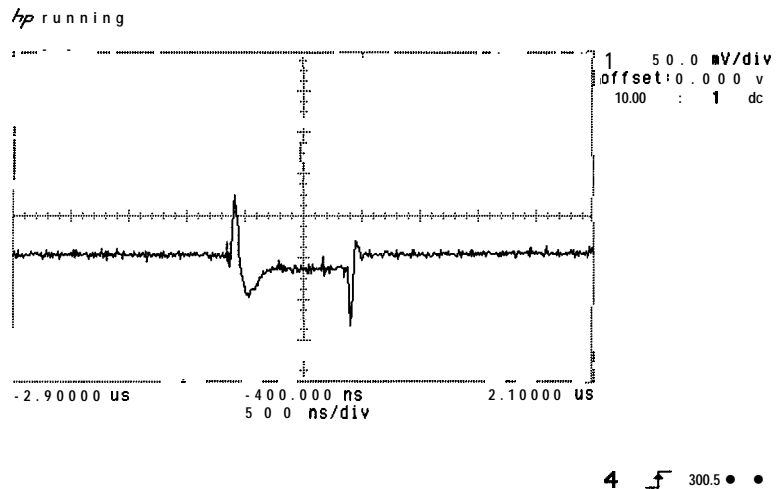

Figure 3-107. Waveform Before Adjustment

19. Connect the oscilloscope Channel 1 probe to A3A3TP7.
20. Adjust A3A2R51 Y S&H BAL for minimum dc offset between the level of the signal inside the two pulses to the signal level outside the two pulses.
21. Set spectrum analyzer LINE switch to STANDBY.
22. Reinstall A3A3 Line Generator in spectrum analyzer without extender boards.
23. Set spectrum analyzer LINE switch to ON.

24. Digital Storage Display Adjustments

X and Y Offset and Gain Adjustments

24. Press **(2-22 GHz)**.
25. Key in **(FREQUENCY SPAN]** 0 Hz, **[SWEEP TIME]** 100 μ s.
26. Disconnect cable 9 (white) from **A3A9J2** and connect to **A3A2J2** LG/FS test connector on **A3A2** Intensity Control; the other end of the cable remains connect connected to **A3A2J1**.
27. Select TRIGGER **(VIDEO)** and adjust front-panel LEVEL control for a stable display on instrument CRT.
28. Adjust **A3A1R34** SWP OFFSET so that the signal trace begins at the left edge graticule line. Refer to Figure 3-105 for location of adjustment.
29. Adjust **A3A3R4** X GAIN for twenty cycles displayed on the CRT graticule. This may be made easier by adjusting **A3A1R34** SWP OFFSET so that the first peak is centered on the left edge graticule line, then adjusting **A3A3R4** X GAIN for two cycles per division with the twenty-first cycle being centered on the right edge graticule line. **A3A1R34** SWP OFFSET must then be readjusted so that the trace begins at the left edge graticule line. See Figure 3-105. for location of adjustment.
30. Remove the cable 9 (white) from **A3A2J2** LG/FS test connector and reconnect to **A3A9J2**.
31. Remove cable 7 (violet) from **A4A1J1**. Short **A3A9TP1** to **A3A9TP3** or connect an SMB snap-on short to **A3A9J1**.
32. Connect DVM to **A3A9TP3** and DVM ground to **A3A9TP1**.
33. Press LIN pushbutton.
34. DVM indication should be 0.000 f0.002 V dc.
35. Adjust **A3A3R43** YOS to align the bottom graticule line with the fast sweep signal trace.
36. Remove the short between **A3A9TP1** and **A3A9TP3** (or the SMB snap-on short) and reconnect cable 7 (violet) to **A4A1J1**.
37. Key in **(CENTER FREQUENCY)** 100 MHz. Connect CAL OUTPUT to RF INPUT. Press LOG **(ENTER dB/DIV)** 10 dB.
38. Connect the DVM to **A4A1TP3** and the DVM ground to the IF casting.
39. Press **(REFERENCE LEVEL)** and adjust DATA knob and the frontpanel AMPTD CAL adjust for DVM indication of +2.000 f0.002 V dc.
40. Adjust **A3A3R5** Y GAIN to align the top graticule line with the fast sweep signal trace.

24. Digital Storage Display Adjustments

Final Graticule Adjustments

41. Press **2 - 22 GHz**, TRACE A **BLANK**.
42. Set A3A2R12 LL THRESH fully clockwise.
43. Adjust A3A3R6 XLL and A3A3R9 YLL to align horizontal and vertical lines so that each line meets the edge line (right, left, top, or bottom) but does not overshoot.
44. Adjust A3A2R12 LL THRESH fully counterclockwise.
45. Adjust A3A3R7 XSL and A3A348 YSL to align horizontal and vertical graticule lines so that each line meets the edge line (right, left, top, or bottom) but does not overshoot.
46. Adjust A3A2R12 LL THRESH clockwise until all graticule lines switch over to long lines. This is indicated by a noticeable increase in graticule line intensity. (All graticule lines should increase in intensity.)

X and Y Expand Adjustments

47. Press **2 - 22 GHz**.
48. Key in MARKER **NORMAL**.
49. Adjust A3A3R1 X EXP to center the letter "F" in "REF" (CRT annotation in upper left corner of display) over the left edge graticule line.
50. Adjust A3A3R2 Y EXP to align the remainder of the CRT annotation so that the upper annotation (MARKER data) is above the top graticule line and the lower annotation (START and STOP data) is below the bottom graticule line. Adjust for equal spacing above and below the graticule pattern.

Low-Noise DC Supply

The Low-Noise DC Supply shown in Figure 3-108 can be constructed using the parts listed in Table 3-17.

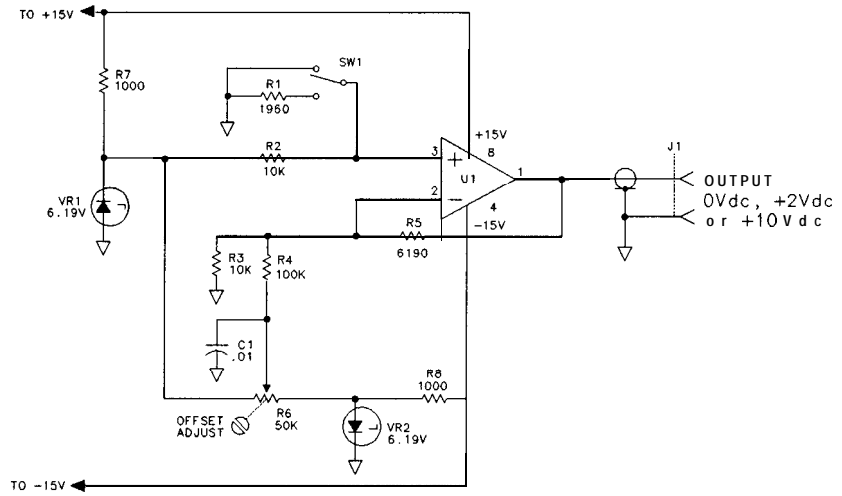

Figure 3-108. Low-Noise DC Supply

Table 3-17. Parts for Low-Noise DC Supply

Reference/Designation	HP Part Number	CD	Description
C1	0160-2055	9	CAPACITOR FXD .01 μ f
J1	1250-0083	1	CONNECTOR BNC
R1	0698-0083	8	RESISTOR FXD 1.96K 1% .125W
R2	0757-0442	9	RESISTOR FXD 10K 1% .125W
R3	0757-0442	9	RESISTOR FXD 10K 1% .125W
R4	0757-0465	6	RESISTOR FXD 100K 1% .125W
R5	0757-0290	5	RESISTOR FXD 6.19 K 1% .125W
R6	2100-2733	6	RESISTOR VARIABLE 50K 20%
R7	0757-0280	3	RESISTOR FXD 1K 1% .125W
R8	0757-0280	3	RESISTOR FXD 1K 1% .125W
S1	3101-1792	8	SWITCH TOGGLE, 3-POSITION
U1	1826-0092	3	IC DUAL OP-AMP
VR1	1902-0049	2	DIODE BREAKDOWN 6.19V
VR2	1902-0049	2	RESISTOR FXD 1.96K 1% .125W

Crystal Filter Bypass Network Configuration

The Crystal Filter Bypass Network Configuration shown in Figure 3-109 can be constructed using the parts listed in Table 3-18 and Table 3-19. Table 3-18 list the parts required for the construction of 21.4 MHz IF crystal-filter bypass networks used with the A4A4 and A4A8 assemblies. Two 21.4 MHz bypass networks are required. Table 3-19 list the parts required for the construction of 3 MHz IF crystal-filter bypass networks used with the A4A7 assembly. Four 3 MHz bypass networks are required.

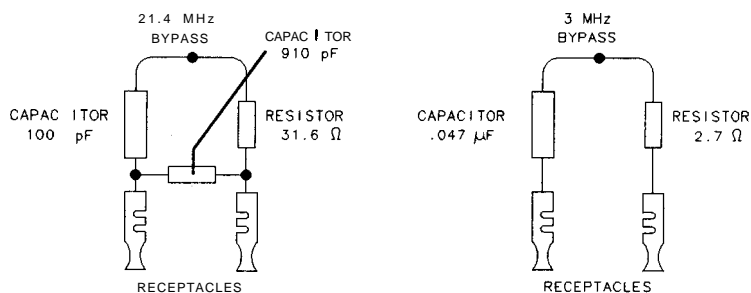

ga12b

Figure 3-109. Crystal Filter Bypass Network Configurations

Table 3-18.
Crystal Filter Bypass Network Configuration for A4A4 and A4A8 (21.4 MHz)

Part	Value	Qty.	HP Part Number
Resistor	31.69	2	0698-7200
Capacitor	100 pF	2	0160-4801
Capacitor	910 pF	2	0160-6146
Receptacle		4	1251-3720

Table 3-19.
Crystal Filter Bypass Network Configuration for A4A7 (3MHz)

Part	Value	Qty.	HP Part Number
Resistor	2.79	4	0683-0275
Capacitor	0.047 μ F	4	0170-0040
Receptacle		8	1251-3720

Option 462

Introduction

This chapter contains modified performance tests and adjustment procedures for Option 462 instruments. When working on Option 462 instruments, substitute the procedures in this chapter for the standard versions contained in chapters two and three. For earlier Option 462 instruments (HP 85662A serial prefixes below 3341A) in which impulse bandwidths are specified, use the tests and adjustment under “Impulse Bandwidths”. The procedures included in this chapter are listed below:

6 dB Bandwidths:

Performance Tests

Test 3, 6 dB Resolution Bandwidth Accuracy Test 4-2

Test 4, 6 dB Resolution Bandwidth Selectivity Test 4-10

Adjustment Procedure

Adjustment 9, 6 dB Bandwidth Adjustments 4-23

Impulse Bandwidths:

Performance Tests

Test 3, Impulse and Resolution Bandwidth Accuracy Test . . . 4-4

Test 4, Impulse and Resolution Selectivity Test 4-13

Test 5, Impulse and Resolution Bandwidth Switching

Uncertainty Test 4-16

Adjustment Procedure

Adjustment 9, Impulse Bandwidth Adjustments.. . . . 4-26

3. 6 dB Resolution Bandwidth Accuracy Test

Related Adjustment 6 dB Bandwidth Adjustments

Specification ±20%, 3 MHz bandwidth
 ± 10%, 30 Hz to 1 MHz bandwidths
 + 50%, -0%, 10 Hz bandwidth

30 kHz and 100 kHz bandwidth accuracy figures only applicable ≤90% Relative Humidity, ≤40° C .

Description The 6 dB bandwidth for each resolution bandwidth setting is measured with the MARKER function to determine bandwidth accuracy. The CAL OUTPUT is used for a stable signal source.

Equipment None required

- Procedure**
1. Press **2 - 22 GHz**.
 2. Connect CAL OUTPUT to RF INPUT.
 3. Key in spectrum analyzer settings as follows:

[CENTER FREQUENCY]	100 MHz
[FREQUENCY SPAN]	5 MHz
[RES BW]	3 MHz
[REFERENCE LEVEL]	-10 dBm
 4. Press SCALE LIN pushbutton. Press **[SHIFT]**, **[AUTO]**^A (resolution bandwidth) for units in dBm.
 5. Adjust **[REFERENCE LEVEL]** to position peak of signal trace at (or just below) reference level (top) graticule line. Press SWEEP **[SINGLE]**.
 6. Press MARKER **[NORMAL]** and place marker at peak of signal trace with DATA knob. Press MARKER [a] and position movable marker 6 dB down from the stationary marker on the positive-going edge of the signal trace (the MARKER A amplitude readout should be -6.00 dB f0.05 dB). It may be necessary to press SWEEP **[CONT]** and adjust **[CENTER FREQUENCY]** to center trace on screen.
 7. Press MARKER [a] and position movable marker 6 dB down from the signal peak on the negative-going edge of the trace (the MARKER A amplitude readout should be .00 dB f0.05 dB). The 6 dB bandwidth is given by the MARKER A frequency readout. (See Figure 4-1.) Record this value in Table 4-1.

3. 6 dB Resolution Bandwidth Accuracy Test

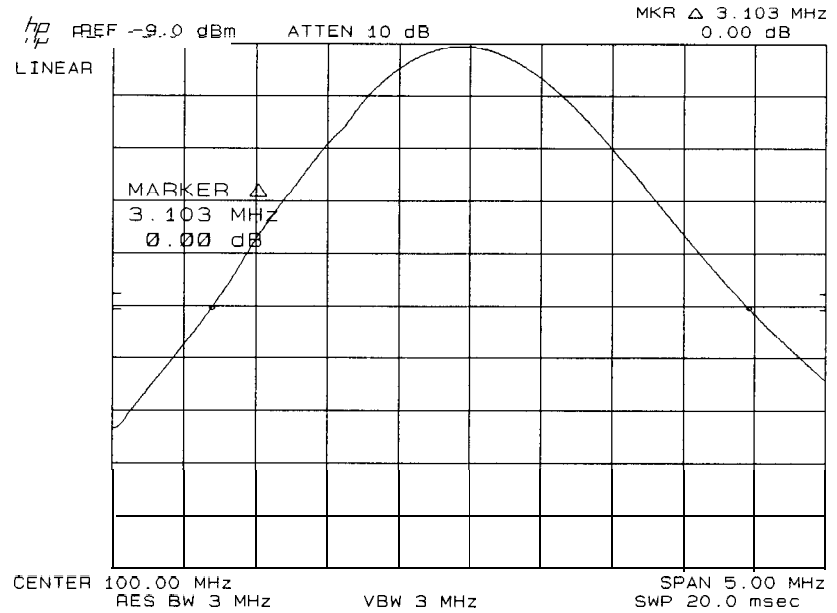

Figure 4-1. Resolution Bandwidth Measurement

- Vary spectrum analyzer settings according to Table 4-1. Press SWEEP **(SINGLE)** and measure the 6 dB bandwidth for each resolution bandwidth setting by the procedure of steps 6 and 7 and record the value in Table 4- 1. The measured bandwidth should fall between the limits shown in the table.

Table 4-1. 6 dB Resolution Bandwidth Accuracy

RES BW	FREQUENCY SPAN	MARKER Δ Readout of 6 dB Bandwidth		
		Min	Actual	Max
3 MHz	5 MHz	2.400 MHz		3.600 MHz
1 MHz	2 MHz	900 kHz		1.100 MHz
300 kHz	500 kHz	270.0 kHz		330.0 kHz
100 kHz	200 kHz	90.0 kHz		110.0 kHz
30 kHz	50 kHz	27.00 kHz		33.00 kHz
10 kHz	20 kHz	9.00 kHz		11.00 kHz
3 kHz	5 kHz	2.700 kHz		3.300 kHz
1 kHz	2 kHz	900 Hz		1.100 kHz
300 Hz	500 Hz	270 Hz		330 Hz
100 Hz	200 Hz	90 Hz		110 Hz
30 Hz	100 Hz	27.0 Hz		33.0 Hz
10 Hz	100 Hz	10.0 Hz		15.0 Hz

3. Impulse and Resolution Bandwidth Accuracy Test

Related Adjustment Impulse Bandwidth Adjustments

Specification $\pm 20\%$, 3 MHz bandwidth
 $\pm 10\%$, 1 MHz to 1 kHz bandwidths
 $-0, +50\%$, 300 Hz to 10 Hz (6 dB bandwidths)

Description A frequency synthesizer and pulse/function generator are used to input pulses to the spectrum analyzer. The amplitude of the pulses is measured, and the impulse bandwidths are calculated for each impulse bandwidth from 3 MHz to 1 kHz. The 6 dB resolution bandwidths are then measured using the spectrum analyzer **MARKER** function. The CAL OUTPUT signal is used as a stable signal source to measure the 6 dB resolution bandwidths.

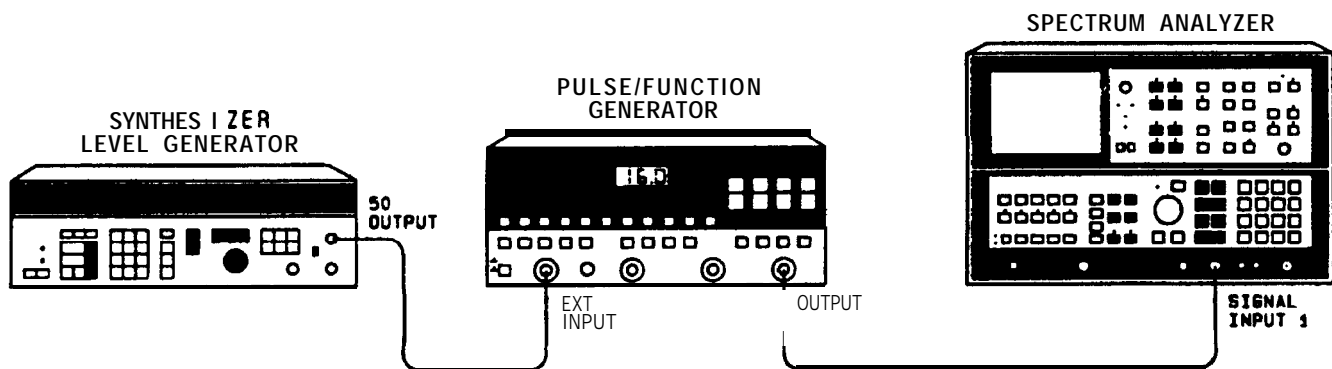

Figure 4-2. Impulse Bandwidth Test Setup

Equipment	Frequency Synthesizer	HP 3335A
	Pulse/Function Generator	HP 8116A

3. Impulse and Resolution Bandwidth Accuracy Test

Procedure

1. Set the frequency synthesizer for a 15 MHz, + 13 dBm output. Connect the output of the frequency synthesizer to the EXT INPUT of the pulse/function generator.
2. Set the pulse/function generator controls as follows:

MODE	TRIG
EXT INPUT	positive-going
EXT INPUT LEVEL	midrange
OUTPUT	pulse
LOL	ov
HIL	0.4V
WIDTH (WID)	10 ns
DISABLE	off

Note

The spectrum analyzer REFERENCE LEVEL setting should remain at 0 dBm throughout steps 4 through 38 to prevent possible IF gain compression of the pulse signal.

3. On the spectrum analyzer, press **2-22 GHz** and set the controls as follows:

CENTER FREQUENCY	15 MHz
FREQUENCY SPAN	12 MHz
ATTEN	20 dB
RES BW	3 MHz (i)
VIDEO BW	3 MHz
REFERENCE LEVEL	.0dBm

4. On the spectrum analyzer, press **SHIFT**, **ATTEN**, **AUTO**^D, **SWEEP SINGLE**, **MARKER** PEAK SEARCH. Note the MARKER amplitude for the 3 MHz filter in the HIGH FREQUENCY REPETITION RATE column in Table 4-2.
5. Set the frequency synthesizer **FREQUENCY** to 300 kHz.
6. On the spectrum analyzer, press FREQUENCY SPAN 0 Hz, SWEEP TIME 0.5 seconds, **SWEEP SINGLE**.
7. Press **MARKER** PEAK SEARCH. Note the MARKER amplitude for the 3 MHz filter in the LOW FREQUENCY REPETITION RATE column in Table 4-2.
8. Calculate the Impulse Bandwidth of the 3 MHz Alter using the formula shown below and record the results for the 3 MHz filter in Table 4-2.

$$BW(i) = \text{High frequency rep rate (15 MHz)} \times (\text{Low frequency reading (step 7)/Hi frequency reading(step 4)})$$

9. Set the frequency synthesizer FREQUENCY to 10 MHz.
10. On the spectrum analyzer, key in CENTER FREQUENCY 10 MHz, **RES BW** 1 MHz (i), FREQUENCY SPAN 4 MHz, **SWEEP TIME** **AUTO**, **SWEEP SINGLE**, **MARKER** PEAK SEARCH. Record MARKER amplitude in Table 4-2
11. Set the frequency synthesizer **FREQUENCY** to 100 kHz.
12. On the spectrum analyzer, key in FREQUENCY SPAN 0 Hz, SWEEP TIME 0.5 seconds, **SWEEP SINGLE**.

3. Impulse and Resolution Bandwidth Accuracy Test

13. Press MARKER [PEAK SEARCH]. Record the MARKER amplitude in Table 4-2.
14. Calculate the impulse bandwidth of the 1 MHz filter using the formula in step 8. Record the result in Table 4-2.
15. Set the frequency synthesizer [FREQUENCY] to 3 MHz. Set the pulse/function generator WID to 33.3 ns.
16. On the spectrum analyzer, key in: [RES BW] 300 kHz (i), [CENTER FREQUENCY] 3 MHz, [FREQUENCY SPAN] 1.2 MHz, SWEEP TIME [AUTO], SWEEP [SINGLE], MARKER [PEAK SEARCH]. Record MARKER amplitude in Table 4-2.
17. Set the frequency synthesizer [FREQUENCY] to 30 kHz. On the spectrum analyzer key in [FREQUENCY SPAN] 0 Hz, [SWEEP TIME] 0.5 seconds, SWEEP [SINGLE], MARKER [PEAK SEARCH]. Record MARKER amplitude in Table 4-2.
18. Calculate the Impulse BW of the 300 kHz filter using the formula in step 8. Record in Table 4-2.
19. Set the frequency synthesizer [FREQUENCY] to 1 MHz. Set the pulse/function generator WID to 100 ns.
20. On the spectrum analyzer key in: [RES BW] 100 kHz (i), [VIDEO BW] 1 MHz, [CENTER FREQUENCY] 1 MHz, [FREQUENCY SPAN] 400 kHz, SWEEP TIME [AUTO], SWEEP [SINGLE], MARKER [PEAK SEARCH]. Record MARKER amplitude in Table 4-2.
21. Set the frequency synthesizer [FREQUENCY] to 10 kHz. On the spectrum analyzer, key in: [FREQUENCY SPAN] 0 Hz, [SWEEP TIME] 0.5 seconds, SWEEP [SINGLE], MARKER [PEAK SEARCH]. Record MARKER amplitude in Table 4-2.
22. Calculate the Impulse BW of the 100 kHz filter using the formula in step 8. Record in Table 4-2.
23. Set the frequency synthesizer [FREQUENCY] to 300 kHz. Set the pulse/function generator WID to 333 ns.
24. On the spectrum analyzer, key in: [RES BW] 30 kHz (i), [VIDEO BW] 300 kHz, [CENTER FREQUENCY] 300 kHz, [FREQUENCY SPAN] 120 kHz, SWEEP TIME [AUTO], SWEEP [SINGLE], MARKER [PEAK SEARCH]. Record MARKER amplitude in Table 4-2.
25. Set the frequency synthesizer [FREQUENCY] to 3 kHz. On the spectrum analyzer, key in: [FREQUENCY SPAN] 0 Hz, [SWEEP TIME] 0.5 seconds, SWEEP [SINGLE], MARKER [PEAK SEARCH]. Record MARKER amplitude in Table 4-2.
26. Calculate the Impulse BW of the 30 kHz filter using the formula in step 8. Record in Table 4-2.
27. Set the frequency synthesizer [FREQUENCY] to 100 kHz. Set the pulse/function generator WID to 1 μ s.
28. On the spectrum analyzer key in [RES BW] kHz (i), [VIDEO BW] 100 kHz, [CENTER FREQUENCY] 100 Hz, [FREQUENCY SPAN] 40 kHz, SWEEP TIME [AUTO], SWEEP [SINGLE], MARKER [PEAK SEARCH]. Record MARKER amplitude in Table 4-2.

3. Impulse and Resolution Bandwidth Accuracy Test

29. Set the frequency synthesizer **(FREQUENCY)** to 1 kHz. On the spectrum analyzer key in: **(FREQUENCY SPAN)** 0 Hz, **(SWEEP TIME)** 0.5 seconds, **(SWEEP SINGLE)**, **MARKER (PEAK SEARCH)**. Record **MARKER** amplitude in **Table 4-2**.
30. Calculate the Impulse BW of the 10 kHz filter using the formula in step 8. Record in **Table 4-2**.
31. Set the frequency synthesizer **(FREQUENCY)** to 30 kHz. Set the pulse/function generator **WID** to 3.33 μ s.
32. On the spectrum analyzer key in: **(RES BW)** 3 kHz (i), **(VIDEO BW)** 30 kHz, **(CENTER FREQUENCY)** 30 kHz, **(FREQUENCY SPAN)** 12 kHz, **SWEEP TIME (AUTO)**, **SWEEP (SINGLE)**, **MARKER (PEAK SEARCH)**. Record **MARKER** amplitude in **Table 4-2**.
33. Set the frequency synthesizer **(FREQUENCY)** to 300 Hz. On the spectrum analyzer key in: **(FREQUENCY SPAN)** 0 Hz, **(SWEEP TIME)** 0.5 seconds, **SWEEP (SINGLE)**, **MARKER (PEAK SEARCH)**. Record **MARKER** amplitude in **Table 4-2**.
34. Calculate the Impulse BW of the 3 kHz filter using the formula in step 8. Record in **Table 4-2**.
35. Set the frequency synthesizer **(FREQUENCY)** to 10 kHz. Set the pulse/function generator **WID** to 10 μ s.
36. On the spectrum analyzer key in **(RES BW)** 1 kHz (i), **(VIDEO BW)** 10 kHz, **(CENTER FREQUENCY)** 10 kHz, **(FREQUENCY SPAN)** 4 kHz **SWEEP TIME (AUTO)**, **SWEEP (SINGLE)**, **MARKER (PEAK SEARCH)**. Record **MARKER** amplitude in **Table 4-2**.
37. Set the frequency synthesizer **(FREQUENCY)** to 200 Hz. On the spectrum analyzer key in: **(FREQUENCY SPAN)** 0 Hz, **(SWEEP TIME)** 0.5 seconds, **SWEEP (SINGLE)**, **MARKER (PEAK SEARCH)**. Record **MARKER** amplitude in **Table 4-2**.
38. Calculate the Impulse BW of the 1 kHz filter using the formula in step 8. Record in **Table 4-2**.
39. On the spectrum analyzer, press **(2-22 GHz)**.
40. Connect the spectrum analyzer **CAL OUTPUT** to **RF INPUT**.
41. On the spectrum analyzer, key in the following settings:

(CENTER FREQUENCY)	100 MHz
(FREQUENCY SPAN)5 MHz
(RES BW)	3 MHz (i)
(REFERENCE LEVEL)	-10 dBm
42. On the spectrum analyzer, press **SCALE (LIN)**. Press **(SHIFT) RES BW (AUTO) ^**, for units in dBm.
43. On the spectrum analyzer, press the **(REFERENCE LEVEL)** and use the **DATA** knob to position the signal peak near the reference level (top graticule line). Press **SWEEP (SINGLE)**.
44. On the spectrum analyzer, press **MARKER (NORMAL)**, and place the marker at the signal peak with the **DATA** knob. Press **MARKER [a]** and position the movable marker 6 dB down from the stationary marker on the positive going edge of the signal trace (the **MARKER [Δ]** amplitude readout should be -6.00 dB f0.05

3. Impulse and Resolution Bandwidth Accuracy Test

dB). To center the trace on screen, it may be necessary to press SWEEP **(CONT)** and adjust (CENTER FREQUENCY).

45. Press MARKER **(Δ)** and position movable marker 6 dB down from the signal peak on the negative going edge of the trace (the MARKER **(Δ)** amplitude readout should be 0.00 dB ±0.05dB). The 6 dB bandwidth is given by the MARKER **(Δ)** frequency readout. (See Figure 4-3.) Record in Table 4-2.

Note

6 dB resolution bandwidth measurements are used in Performance Test 4, Impulse **and** Resolution Bandwidth Selectivity Test.

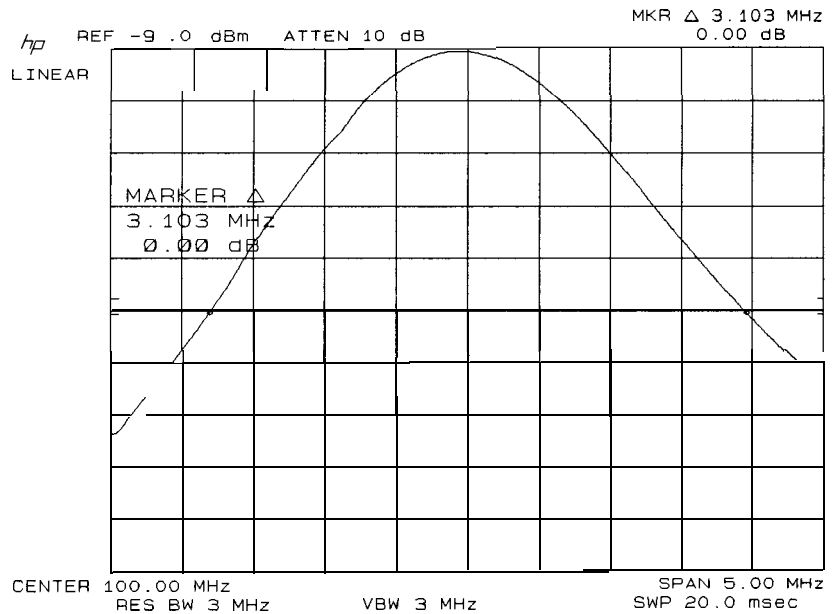

Figure 4-3. 6 dB Resolution Bandwidth Measurement

46. Select the spectrum analyzer (RES BW) and (FREQUENCY SPAN) settings according to Table 4-3. Press SWEEP **(SINGLE)** and measure the 6 dB bandwidth for each resolution bandwidth setting using the procedure of steps 43 through 45 and record the value in Table 4-3. The measured bandwidths for 300 Hz, 100 Hz, 30 Hz, and 10 Hz should fall between the limits shown in the table.

3. Impulse and Resolution Bandwidth Accuracy Test

Table 4-2. Impulse Bandwidth Accuracy

Res BW	VIDEO BW	Marker Readouts for:		Calculated Impulse Bandwidth		
		High Frequency Repetition Rate	Low Frequency Repetition Rate	Minimum	Actual	Maximum
3 MHz (i)	3 MHz	_____	_____	2.40 MHz	_____	3.60 MHz
1 MHz (i)	3 MHz	_____	_____	900 kHz	_____	1.1 MHz
300 kHz (i)	3 MHz	_____	_____	270 kHz	_____	330 kHz
100 kHz (i)	1 MHz	_____	_____	90 kHz	_____	110 kHz
30 kHz (i)	300 kHz	_____	_____	27 kHz	_____	33 kHz
10 kHz (i)	100 kHz	_____	_____	9 kHz	_____	11 kHz
3 kHz (i)	30 kHz	_____	_____	2.7 kHz	_____	3.3 kHz
1 kHz (i)	10 kHz	_____	_____	900 Hz	_____	1.1 kHz

Table 4-3. 6 dB Resolution Bandwidth Accuracy

Res BW	IFrequency Span	MARKER Δ Readout of 6 dB Bandwidth		
		Minimum	Actual	Maximum
3 MHz (i)	5 MHz		_____	
1 MHz (i)	2 MHz		_____	
300 kHz (i)	500 kHz		_____	
100 kHz (i)	200 kHz		_____	
30 kHz (i)	50 kHz		_____	
10 kHz (i)	20 kHz		_____	
3 kHz (i)	5 kHz		_____	
1 kHz (i)	2 kHz		_____	
300 Hz (i)	500 Hz	300 Hz	_____	450 Hz
100 Hz (i)	200 Hz	100 Hz	_____	150 Hz
30 Hz (i)	100 Hz	30 Hz	_____	45 Hz
10 Hz (i)	100 Hz	10 Hz	_____	15 Hz

4. 6 dB Resolution Bandwidth Selectivity Test

Related Adjustments

3 MHz Bandwidth Filter Adjustments
 21.4 MHz Bandwidth Filter Adjustments
 Step Gain and 18.4 MHz Local Oscillator Adjustments

Specification

60 dB/6 dB bandwidth ratio:
 <11:1, 3 MHz to 100 kHz bandwidths
 <8: 1, 30 kHz to 30 Hz bandwidths
 60 dB points on 10 Hz bandwidths are separated by <100 Hz

Description

Bandwidth selectivity is found by measuring the 60 dB bandwidth and dividing this value by the 6 dB bandwidth for each resolution bandwidth setting from 30 Hz to 3 MHz. The 60 dB points for the 10 Hz bandwidth setting are also measured. The CAL OUTPUT provides a stable signal for the measurements.

Equipment

None required

Note

Performance Test 3, 6 dB Resolution Bandwidth Accuracy Test, must be performed before starting this test.

Procedure

1. Press **2 - 22 GHz**.
2. Connect CAL OUTPUT to RF INPUT.
3. Key in analyzer control settings as follows:

CENTER FREQUENCY	100 MHz
FREQUENCY SPAN	20 MHz
RES BW	3 MHz
VIDEO BW	100 Hz
SWEEP SINGLE		

4. Press MARKER **NORMAL** and position marker at peak of signal trace. Press MARKER **Δ** and position movable marker 60 dB down from the stationary marker on the positive-going edge of the signal trace (the MARKER A amplitude readout should be -60.00 dB f1.00 dB). It may be necessary to press SWEEP **CONT** and adjust **CENTER FREQUENCY** so that both 60 dB points are displayed. (See Figure 4-4.)
5. Press MARKER **Δ** and position movable marker 60 dB down from the signal peak on the negative-going edge of the signal trace (the MARKER A amplitude readout should be .00 dB f0.50 dB).
6. Read the 60 dB bandwidth for the 3 MHz resolution bandwidth setting from the MARKER A frequency readout (Figure 4-4) and record the value in Table 4-4.

4. 6 dB Resolution Bandwidth Selectivity Test

7. Vary spectrum analyzer settings according to Table 4-4. Press SWEEP **SINGLE** and measure the 60 dB bandwidth for each resolution bandwidth setting by the procedure of steps 4 through 6. Record the value in Table 4-4.
8. Record the 6 dB bandwidths from Table 4-1 in Table 4-4.
9. Calculate the bandwidth selectivity for each setting by dividing the 60 dB bandwidth by the 6 dB bandwidth. The bandwidth ratios should be less than the maximum values shown in Table 4-4.
10. The 60 dB bandwidth for the 10 Hz resolution bandwidth setting should be less than 100 Hz.

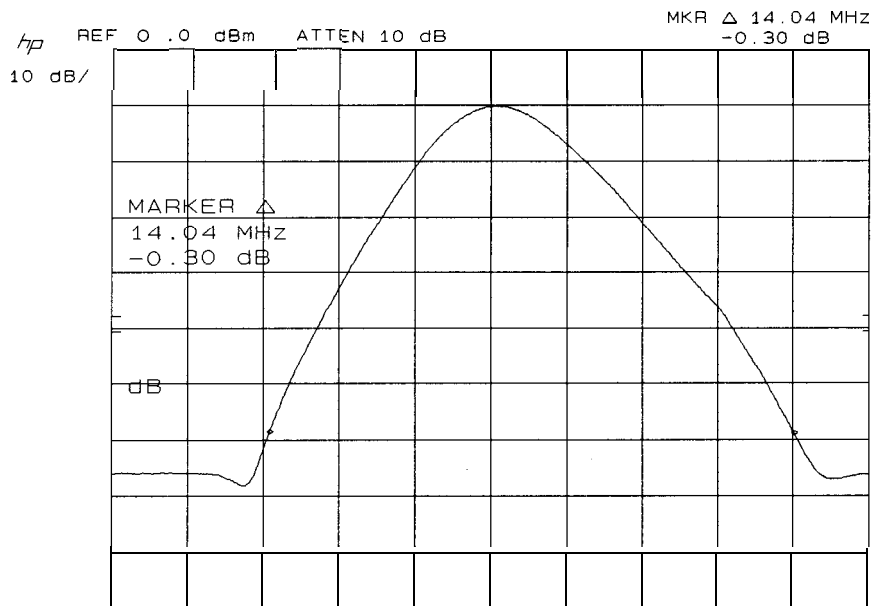

Figure 4-4. 60 dB Bandwidth Measurement

4. 6 dB Resolution Bandwidth Selectivity Test

Table 4-4. 6 dB Resolution Bandwidth Selectivity

Spectrum Analyzer			Measured 60 dB Bandwidth	Measured 6 dB Bandwidth	Bandwidth Selectivity (60 dB BW ÷ 6 dB BW)	Maximum Selectivity Ratio
RES BW	FREQUENCY SPAN	[V I D E O]				
3 MHz	20 MHz	100 Hz			_____	11:1
1 MHz	15 MHz	300 Hz			_____	11:1
300 kHz	5 MHz	AUTO			_____	11:1
100 kHz	2 MHz	AUTO			_____	11:1
30 kHz	500 kHz	AUTO			_____	8:1
10 kHz	200 kHz	AUTO			_____	8:1
3 kHz	50 kHz	AUTO			_____	8:1
1 kHz	10 kHz	AUTO			_____	8:1
300 Hz	5 kHz	AUTO			_____	8:1
100 Hz	2 kHz	AUTO			_____	8:1
30 Hz	500 Hz	AUTO			_____	8:1
10 Hz	100 HZ	AUTO		60 dB points separated by <100 Hz		

4. Impulse and Resolution Bandwidth Selectivity Test

Related Adjustment 3 MHz Bandwidth Filter Adjustments
2 1.4 Bandwidth Filter Adjustments
Step Gain and 18.4 MHz Local Oscillator Adjustments

Specification 60 dB/6 dB bandwidth ratio:
<11:1, 3 MHz to 100 kHz
<8:1, 30 kHz to 30 Hz
60 dB points on 10 Hz bandwidth are separated by <100 Hz

Description Bandwidth selectivity is found by measuring the 60 dB bandwidth and dividing this value by the 6 dB bandwidth for each resolution bandwidth setting from 30 Hz to 3 MHz. The 60 dB points for the 10 Hz bandwidth setting are also measured. The CAL OUTPUT provides a stable signal for the measurements.

Note Resolution Bandwidth Accuracy Test must be performed before this test.

Equipment None required

Procedure 1. On the spectrum analyzer press **2-22 GHz** and connect the CAL OUTPUT to RF INPUT.

2. Key in spectrum analyzer control settings as following:

CENTER FREQUENCY	100 MHz
FREQUENCY SPAN	20 MHz
RES BW	3 MHz
VIDEO BW	100 Hz
SWEEP	SINGLE

3. On the spectrum analyzer, press **MARKER NORMAL** and position the marker at the peak of the signal trace using the DATA knob. Press **MARKER In]** and position the movable marker 60 dB down from the stationary marker on the positive going edge of the signal trace (the **MARKER Δ** amplitude readout should be -60.00 dB fl.00 dB). It may be necessary to press **SWEEP CONT** and to adjust **CENTER FREQUENCY SO** that both 60 dB points are displayed (see Figure 4-5).

4. Impulse and Resolution Bandwidth Selectivity Test

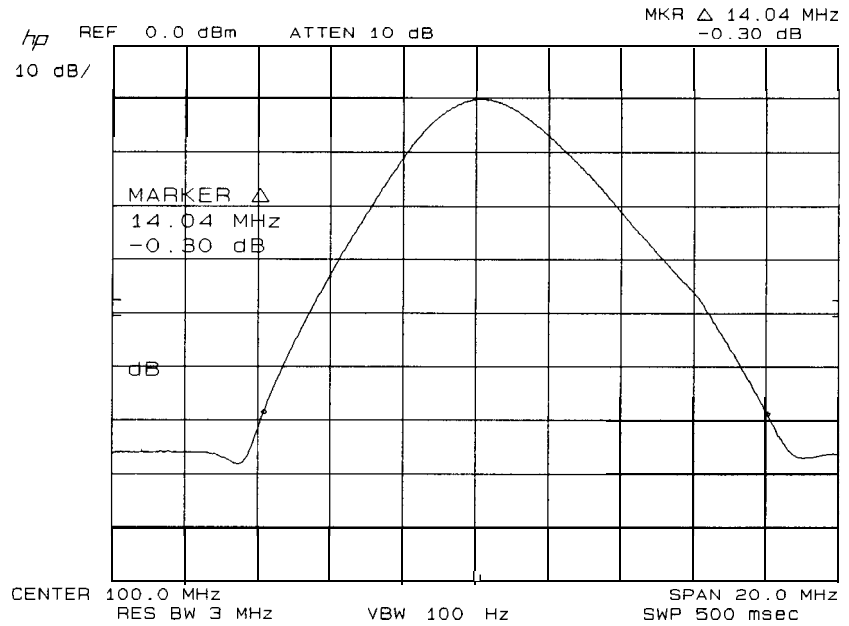

Figure 4-5. 60 dB Bandwidth Measurement

4. Press MARKER [A] and position the positive movable marker 60 dB down from the signal peak on the negative-going edge of the signal trace (the MARKER [A] amplitude readout should be 0.00 dB f0.50 dB).
5. Read the 60 dB bandwidth for the 3 MHz resolution bandwidth setting from the MARKER [A] frequency readout (see Figure 4-5) and record the value in Table 4-5.
6. Select the spectrum analyzer RES BW, FREQUENCY SPAN, and VIDEO BW according to Table 4-5. Measure the 60 dB bandwidth for each resolution bandwidth setting by the procedure of steps 3 through 5 and record the value in Table 4-5.
7. Record the 6 dB bandwidths for each resolution bandwidth setting from Table 4-1 in Table 4-5.
8. Calculate the bandwidth selectivity for each setting by dividing the 60 dB bandwidth by the 6 dB bandwidth. The bandwidth ratios should be less than the maximum values shown in Table 4-5.
9. The 60 dB bandwidth for the 10 Hz resolution bandwidth setting should be less than 100 Hz.

4. Impulse and Resolution Bandwidth Selectivity Test

Table 4-5. Impulse and Resolution Bandwidth Selectivity

Spectrum Analyzer			Measured 60 dB Bandwidth	Measured 6 dB Bandwidth	Bandwidth Selectivity (60 dB BW ÷ 6 dB BW)	Maximum Selectivity Ratio
Res BW	Frequency Span	Video BW				
3 MHz (i)	20 MHz	100 Hz				11:1
1 MHz (i)	15 MHz	300 Hz				11:1
300 kHz (i)	5 MHz	AUTO				11:1
100 kHz (i)	2 MHz	AUTO				11:1
30 kHz (i)	500 kHz	AUTO				8:1
10 kHz (i)	200 kHz	AUTO				8:1
3 kHz (i)	50 kHz	AUTO				8:1
1 kHz (i)	10 kHz	AUTO				8:1
300 Hz (i)	5 kHz	AUTO				8:1
100 Hz (i)	2 kHz	AUTO				8:1
30 Hz (i)	500 Hz	AUTO				8:1
10 Hz (i)	100 Hz	AUTO		50 dB points separated by <100 Hz		

5. Impulse and Resolution Bandwidth Switching Uncertainty Test

Related Adjustment

3 MHz Bandwidth Filter Adjustments
 21.4 MHz Bandwidth Filter Adjustments
 Down/Up Converter Adjustments

Specification

f2.0 dB, 10 Hz bandwidth
 ±0.8 dB, 30 Hz bandwidth
 f0.5 dB, 100 Hz to 1 MHz bandwidth
 f1.0 dB, 3 MHz bandwidth
 30 kHz and 100 kHz bandwidth switching uncertainty figures only applicable ≤90% Relative Humidity.

Description

The CAL OUTPUT signal is applied to the input of the spectrum analyzer. The deviation in peak amplitude of the signal trace is then measured as each resolution bandwidth filter is switched in.

Equipment

None required

Procedure

1. Press **2-22 GHz**.
2. Connect CAL OUTPUT to RF INPUT.
3. Key in the following control settings:

CENTER FREQUENCY	100 MHz
FREQUENCY SPAN5 MHz
REFERENCE LEVEL-8 dBm
RES BW	1 MHz

4. Press LOG **ENTER dB/DIV**, and key in 1 dB. Press MARKER **PEAK SEARCH** **Δ**.
5. Key in settings according to Table 4-6. Press MARKER **PEAK SEARCH** at each setting, then read the amplitude deviation from the MARKER La] readout at the upper right of the display (see Figure 4-6). The allowable deviation for each resolution bandwidth setting is shown in the table.

5. Impulse and Resolution Bandwidth Switching Uncertainty Test

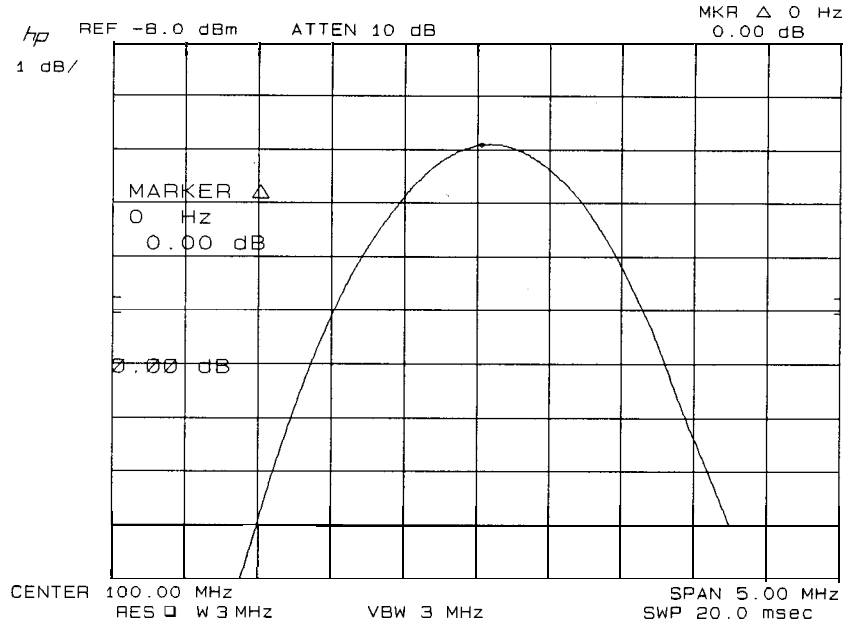

Figure 4-6. Bandwidth Switching Uncertainty Measurement

Table 4-6. Bandwidth Switching Uncertainty

Res BW	Frequency Span	Deviation (MKR A Readout, dB)	Allowable Deviation (dB)
1 MHz (i)	5 MHz	0 (ref.)	0 (ref.)
3 MHz (i)	5 MHz	_____	± 1.0
100 kHz (i)	5 MHz	_____	± 0.5
100 kHz (i)	500 kHz	_____	± 0.5
30 kHz (i)	500 kHz	_____	± 0.5
10 kHz (i)	50 kHz	_____	± 0.5
3 kHz (i)	50 kHz	_____	± 0.5
1 kHz (i)	10 kHz	_____	± 0.5
300 Hz (i)	1 kHz	_____	± 0.5
100 Hz (i)	1 kHz	_____	± 0.5
30 Hz (i)	200 Hz	_____	± 0.8
10 Hz (i)	100 Hz	_____	± 2.0

**Test 3. 6 dB
Resolution
Bandwidth
Accuracy Test (p/o
Table 2-24,
Performance Test
Record)**

Step 8. 6 dB Resolution Bandwidth Accuracy

RES BW	FREQUENCY SPAN	MARKER Δ Readout of 3 dB Bandwidth		
		Min	Actual	Max
3 MHz	5 MHz	2.400 MHz		3.600 MHz
1 MHz	2 MHz	900 kHz		1.100 MHz
300 kHz	500 kHz	270.0 kHz		330.0 kHz
100 kHz	200 kHz	90.0 kHz		110.0 kHz
30 kHz	50 kHz	27.00 kHz		33.00 kHz
10 kHz	20 kHz	9.00 kHz		11.00 kHz
3 kHz	5 kHz	2.700 kHz		3.300 kHz
1 kHz	2 kHz	900 Hz		1.100 kHz
300 Hz	500 Hz	270 Hz		330 Hz
100 Hz	200 Hz	90 Hz		110 Hz
30 Hz	100 Hz	27.0 Hz		33.0 Hz
10 Hz	100 Hz	10.0 Hz		15.0 Hz

Test 3. Impulse and Resolution Bandwidth Accuracy Test (p/o Table 2-24, Performance Test Record)

**Test 3. Impulse
and Resolution
Bandwidth
Accuracy Test (p/o
Table 2-24,
Performance Test
Record)**

Steps 1 through 38. Impulse Bandwidth Accuracy

Res BW	VIDEO BW	Marker Readouts for:		Calculated Impulse Bandwidth		
		High Frequency Repetition Rate	Low Frequency Repetition Rate	Minimum	Actual	Maximum
3 MHz (i)	3 MHz	_____	_____	2.40 MHz	_____	3.60 MHz
1 MHz (i)	3 MHz	_____	_____	900 kHz	_____	1.1 MHz
300 kHz (i)	3 MHz	_____	_____	270 kHz	_____	330 kHz
100 kHz (i)	1 MHz	_____	_____	90 kHz	_____	110 kHz
30 kHz (i)	300 kHz	_____	_____	27 kHz	_____	33 kHz
10 kHz (i)	100 kHz	_____	_____	9 kHz	_____	11 kHz
3 kHz (i)	30 kHz	_____	_____	2.7 kHz	_____	3.3 kHz
1 kHz (i)	10 kHz	_____	_____	900 Hz	_____	1.1 kHz

Test 3. Impulse and Resolution Bandwidth Accuracy Test (p/o Table 2-24, Performance Test Record)

Steps 39 through 46. 6 dB Resolution Bandwidth Accuracy

Res BW	Frequency Span	MARKER Δ Readout of 6 dB Bandwidth		
		Minimum	Actual	Maximum
3 MHz (i)	5 MHz		_____	
1 MHz (i)	2 MHz		_____	
100 kHz (i)	500 kHz		_____	
100 kHz (i)	200 kHz		_____	
30 kHz (i)	50 kHz		_____	
10 kHz (i)	20 kHz		_____	
3 kHz (i)	5 kHz		_____	
1 kHz (i)	2 kHz		_____	
300 Hz (i)	500 Hz	300 Hz	_____	450 Hz
100 Hz (i)	200 Hz	100 Hz	_____	150 Hz
30 Hz (i)	100 Hz	30 Hz	_____	45 Hz
10 Hz (i)	100 Hz	10 Hz	_____	15 Hz

Test 4. 6 dB Resolution Bandwidth Selectivity (p/o Table 2-24, Performance Test Record)

**Test 4. 6 dB
Resolution
Bandwidth
Selectivity (p/o
Table 2-24,
Performance Test
Record)**

Step 9. 6 dB Resolution Bandwidth Selectivity

Spectrum Analyzer			Measured 60 dB Bandwidth	Measured 6 dB Bandwidth	Bandwidth Selectivity (60 dB BW ÷ 6 dB BW)	Maximum Selectivity Ratio
RES BW	(FREQUENCY SPAN)	[VIDEO]				
3 MHz	20 MHz	100 Hz				11:1
1 MHz	15 MHz	300 Hz				11:1
300 kHz	5 MHz	AUTO				11:1
100 kHz	2 MHz	AUTO				11:1
30 kHz	500 kHz	AUTO				8:1
10 kHz	200 kHz	AUTO				8:1
3 kHz	50 kHz	AUTO				8:1
1 kHz	10 kHz	AUTO				8:1
300 Hz	5 kHz	AUTO				8:1
100 Hz	2 kHz	AUTO				8:1
30 Hz	500 Hz	AUTO				8:1
10 Hz	100 HZ	AUTO		60 dB point	separated by <100 Hz	

**Test 4. Impulse
and Resolution
Bandwidth
Selectivity (p/o
Table 2-24,
Performance Test
Record)**

**Steps 5 through 9. Impulse and Resolution Bandwidth
Selectivity**

Spec	Spectrum Analyzer		Measured 60 dB Bandwidth	Measured 6 dB Bandwidth	Bandwidth Selectivity (60 dB BW ÷ 6 dB BW)	Maximum Selectivity Ratio
	Res BW	Frequency Span				
	3 MHz (i)	20 MHz	100 Hz			11:1
	1 MHz (i)	15 MHz	300 Hz			11:1
	300 kHz (i)	5 MHz	AUTO			11:1
	100 kHz (i)	2 MHz	AUTO			11:1
	30 kHz (i)	500 kHz	AUTO			8:1
	10 kHz (i)	200 kHz	AUTO			8:1
	3 kHz (i)	50 kHz	AUTO			8:1
	1 kHz (i)	10 kHz	AUTO			8:1
	300 Hz (i)	5 kHz	AUTO			8:1
	100 Hz (i)	2 kHz	AUTO			8:1
	30 Hz (i)	500 Hz	AUTO			8:1
	10 Hz (i)	100 Hz	AUTO		60 dB points separated by <100 Hz	

Test 5. Impulse and Resolution Bandwidth Switching Uncertainty (p/o Table 2-24, Performance Test Record)

**Test 5. Impulse
and Resolution
Bandwidth
Switching
Uncertainty (p/o
Table 2-24,
Performance Test
Record)**

**Step 5. Impulse and Resolution Bandwidth
Switching Uncertainty**

Res BW	Frequency Span	Deviation (MKR A Readout, dB)	Allowable Deviation (dB)
1 MHz (i)	5 MHz	0 (ref.)	0 (ref.)
3 MHz (i)	5 MHz	_____	± 1.0
300 kHz (i)	5 MHz	_____	± 0.5
100 kHz (i)	500 kHz	_____	± 0.5
30 kHz (i)	500 kHz	_____	± 0.5
10 kHz (i)	50 kHz	_____	± 0.5
3 kHz (i)	50 kHz	_____	± 0.5
1 kHz (i)	10 kHz	_____	± 0.5
300 Hz (i)	1 kHz	_____	± 0.5
100 Hz (i)	1 kHz	_____	± 0.5
30 Hz (i)	200 Hz	_____	± 0.8
10 Hz (i)	100 Hz	_____	± 2.0

9. 6 dB Resolution Bandwidth Adjustments

Reference IF-Display Section
A4A9 IF Control

Related Performance Test 6 dB Resolution Bandwidth Accuracy Test

Description The CAL OUTPUT signal is connected to the RF INPUT. Each of the adjustable resolution bandwidths is selected and adjusted for the proper bandwidth.

Equipment No test equipment is required for this adjustment.

- Procedure**
1. Position the instrument upright and remove the top cover.
 2. Set the LINE switch to On and press **(2-22 GHz)**.
 3. Connect CAL OUTPUT to RF INPUT.
 4. Key in **(CENTER FREQUENCY)** 100 MHz, **(FREQUENCY SPAN)** 5 MHz **(RES BW)** 3 MHz, and **(LIN)**.
 5. Press **(REFERENCE LEVEL)** and adjust the DATA knob to place the signal peak near the top CRT graticule. The signal should be centered about the center line on the graticule.
 6. Press **(PEAK SEARCH)**, **(MKR → CF)**, and **(MARKER Δ)**.
 7. Using the DATA knob, adjust the marker down one side of the display signal to the 6 dB point; CRT MKR A annotation indicates .500 x
 8. Adjust A4A9R60 3 MHz for MKR [al indication of 1.5 MHz while maintaining the marker at .500 X using the DATA knob. Refer to Figure 4-7 for the adjustment location.
 9. Press **(MARKER Δ)**. Adjust the marker to the 6 dB point on the opposite side of the signal (CRT MKR A annotation indicates 1.00 X. There are now two markers; one on each side of the signal at the 6 dB point.
 10. CRT MKR A annotation now indicates the 6 dB bandwidth of the 3 MHz bandwidth filter. The bandwidth should be 3.00 MHz f0.60 MHz
 11. Key in **(RES BW)** 1 MHz, **(FREQUENCY SPAN)** 2 MHz, **(PEAK SEARCH)**, and **(MKR → CF)**. If necessary, readjust by pressing **(REFERENCE LEVEL)** and using the DATA knob to place the signal peak near the top of the graticule.
 12. Press **(MARKER OFF)** then **(MARKER Δ)**.

9. 6 dB Resolution Bandwidth Adjustments

13. Using the DATA knob, adjust the marker down one side of the display signal to the 6 dB point; CRT MKR A annotation indicates .500 x.

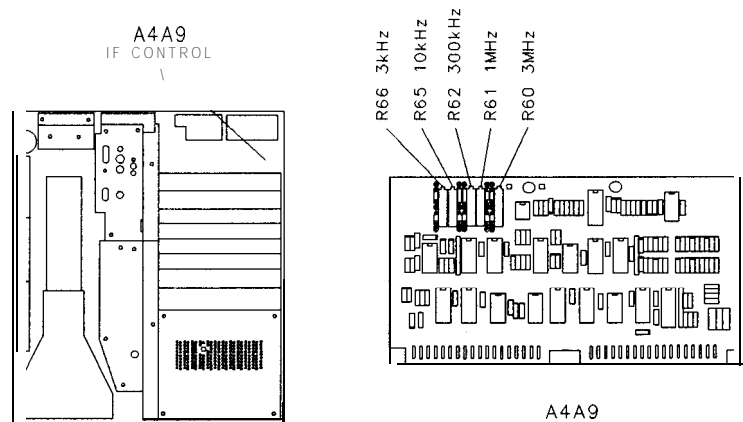

Figure 4-7. Location of Bandwidth Adjustments

14. Adjust A4A9R61 1 MHz for MKR A indication of 500 kHz while maintaining the marker at 0.500 X using the DATA knob. Refer to Figure 4-7 for the adjustment location.
15. Press MARKER [a]. Adjust marker to the opposite side of the signal (CRT MKR A annotation indicate 1.00 X). There are now two markers; one on each of the signal at the 6 dB point.
16. The CRT MKR A annotation now indicates the 6 dB bandwidth of the 1 MHz bandwidth filter. The 6 dB bandwidth should be 1.00 MHz \pm 0.10 MHz.
17. Key in [RES BW] 300 kHz, [FREQUENCY SPAN] 500 kHz, [PEAK SEARCH], and [MKR \rightarrow CF]. If necessary, readjust by pressing [REFERENCE LEVEL] and using the DATA knob to place the signal peak at the top of the graticule.
18. Press MARKER [OFF] then MARKER [Δ].
19. Using the DATA knob, adjust the marker down one the displayed signal to the 6 dB point; CRT MKR A annotation indicates .500 X.
20. Adjust A4A9R62 300 kHz for MKR A indication of 150 kHz while maintaining marker at .500 X using the data knob. Refer to Figure 4-7 for location of adjustment.
21. Press MARKER [Δ]. Adjust the marker to the 6 dB point on the opposite side of the signal (CRT MKR A annotation indicates 1.00 X).
22. The CRT MKR A annotation now indicates the bandwidth of the 300 kHz bandwidth filter. The bandwidth should be 300.00 \pm 30.00 kHz.
23. Key in [RES BW] 10 kHz, [FREQUENCY SPAN] 20 kHz, [PEAK SEARCH], and [MKR \rightarrow CF]. If necessary, readjust by pressing [REFERENCE LEVEL] and using the DATA knob to place the signal peak near the top of the graticule.

9. 6 dB Resolution Bandwidth Adjustments

24. Press MARKER **OFF**, then MARKER **Δ**.
25. Using the DATA knob, adjust the marker down one side of the displayed signal to the 6 dB point; CRT MKR annotation indicates .500 x.
26. Adjust A4A9R65 10 kHz for MKR A indication of 5.00 kHz while maintaining the marker at .500 X using the DATA knob. Refer to Figure 4-7 for the adjustment location.
27. Press MARKER **Δ**. Adjust the marker to the 6 dB point on the opposite side of the signal (CRT MKR A annotation indicates 1.00 X).
28. The CRT MKR A annotation now indicates the 6 dB bandwidth of the 10 kHz bandwidth filter. The bandwidth should be 10.0 fl.O kHz
29. Key in **RES BW** 3 kHz, **FREQUENCY SPAN** 5 kHz, **PEAK_SEARCH**, and **MKR → CF**. If necessary, readjust by pressing **REFERENCE LEVEL** and using the DATA knob to place the signal peak near the top of the graticule.
30. Press MARKER **OFF** and MARKER **Δ**.
31. Using the DATA knob, adjust the marker down one side of the displayed signal to the 6 dB point; CRT MKR A annotation indicates .500 X.
32. Adjust A4A9R66 3 kHz for MKR A indication of 1.5 kHz while maintaining the marker at .500 X using the DATA knob. Refer to Figure 4-7 for the adjustment location.
33. Press MARKER [a]. Adjust the marker to the 6 dB point on the opposite side of the signal (CRT MKR A annotation indicates 1.00 X).
34. The CRT MKR [a] annotation now indicates the 6 dB bandwidth of the 3 kHz bandwidth filter. The bandwidth should be 3.00 ±0.30 kHz

9. Impulse Bandwidth Adjustments

Reference IF-Display Section
A4A9 IF Control

Related Performance Test Impulse Bandwidth Accuracy Test

Description The CAL OUTPUT signal is connected to the RF INPUT. Each of the adjustable resolution bandwidths is selected and adjusted for the proper impulse bandwidth.

Equipment No test equipment is required for this adjustment.

- Procedure**
1. Position the instrument upright and remove the top cover.
 2. Set the LINE switch to On and press **2-22 GHz**.
 3. Connect CAL OUTPUT to RF INPUT.
 4. Key in **CENTER FREQUENCY** 100 MHz, **FREQUENCY SPAN** 5 MHz, **RES BW** 3 MHz, and **LIN**.
 5. Press **REFERENCE LEVEL** and adjust the DATA knob to place the signal peak near the top CRT graticule. The signal should be centered about the center line on the graticule.
 6. Press **PEAK SEARCH**, **MKR** → **CF**, and **MARKER** **Δ**.
 7. Using the DATA knob, adjust the marker down one side of the display signal to the 7.3 dB point; CRT MKR A annotation indicates 0.430 X
 8. Adjust **A4A9R60** 3 MHz for MKR 1a] indication of 1.5 MHz while maintaining the marker at 0.430 X using the DATA knob. Refer to Figure 4-8 for the adjustment location.
 9. Press **MARKER** **Δ**. Adjust the marker to the 7.3 dB point on the opposite side of the signal (CRT MKR A annotation indicates 1.00 X. There are now two markers; one on each side of the signal at the 7.3 dB point.
 10. CRT MKR A annotation now indicates the impulse bandwidth of the 3 MHz bandwidth. Impulse bandwidth should be 3.00 MHz ±0.60MHz
 11. Key in **RES BW** 1 MHz, **FREQUENCY SPAN** 2 MHz, **PEAK SEARCH**, and **MKR** → **CF**. If necessary, readjust by pressing **REFERENCE LEVEL** and using the DATA knob to place the signal peak near the top of the graticule.
 12. Press **MARKER** **OFF** then **MARKER** **Δ**.

9. Impulse Bandwidth Adjustments

13. Using the DATA knob, adjust the marker down one side of the display signal to the 7.3 dB point; CRT MKR A annotation indicates 0.430 X.

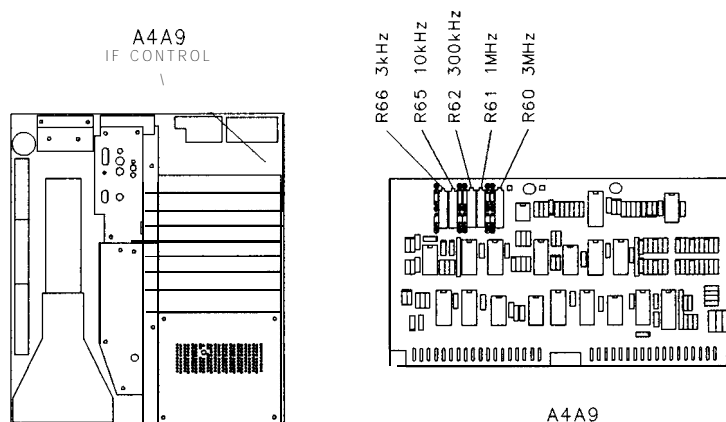

Figure 4-8. Location of Bandwidth Adjustments

14. Adjust A4A9R61 1 MHz for MKR A indication of 500 kHz while maintaining the marker at 0.430 X using the DATA knob. Refer to Figure 4-8 for the adjustment location.
15. Press MARKER Δ . Adjust marker to the opposite side of the signal (CRT MKR A annotation indicate 1.00 X). There are now two markers; one on each of the signal at the 7.3 dB point.
16. The CRT MKR A annotation now indicates the impulse bandwidth of the 1 MHz bandwidth. The impulse bandwidth should be 1.00 MHz \pm 0.10 MHz.
17. Key in **RES BW** 300 kHz, **FREQUENCY SPAN** 500 kHz, **PEAK SEARCH**, and **MKR \rightarrow CF**. If necessary, readjust by pressing **[REFERENCE LEVEL]** and using the DATA knob to place the signal peak at the top of the graticule.
18. Press MARKER **OFF** then MARKER Δ .
19. Using the DATA knob, adjust the marker down one the displayed signal to the 7.3 dB point; CRT MKR A annotation indicates 0.430 X.
20. Adjust A4A9R62 300 kHz for MKR A indication of 150 kHz while maintaining marker at 0.430 X using the data knob. Refer to Figure 4-8 for location of adjustment.
21. Press MARKER Δ . Adjust the marker to the 7.3 dB point on the opposite side of the signal (CRT MKR A annotation indicates 1.00 X).
22. The CRT MKR A annotation now indicates the impulse bandwidth of the 300 kHz bandwidth. The impulse bandwidth should be 300.00 \pm 30.00 kHz.
23. Key in **RES BW** 10 kHz, **FREQUENCY SPAN** 20 kHz, **PEAK SEARCH**, and **MKR \rightarrow CF**. If necessary, readjust by pressing

9. Impulse Bandwidth Adjustments

- REFERENCE LEVEL** and using the DATA knob to place the signal peak near the top of the graticule.
24. Press MARKER **OFF**, then MARKER **Δ**.
 25. Using the DATA knob, adjust the marker down one side of the displayed signal to the 7.3 dB point; CRT MKR annotation indicates 0.430 X.
 26. Adjust **A4A9R65** 10 kHz for MKR A indication of 5.00 kHz while maintaining the marker at 0.430 X using the DATA knob. Refer to Figure 4-8 for the adjustment location.
 27. Press MARKER [a]. Adjust the marker to the 7.3 dB point on the opposite side of the signal (CRT MKR A annotation indicates 1.00 X).
 28. The CRT MKR A annotation now indicates the impulse bandwidth of the 10 kHz bandwidth. The impulse bandwidth should be 10.0 fl.0 kHz
 29. Key in **RES BW** 3 kHz, **FREQUENCY SPAN** 5 kHz, **PEAK SEARCH**, and **MKR → CF**. If necessary, readjust by pressing **REFERENCE LEVEL** and using the DATA knob to place the signal peak near the top of the graticule.
 30. Press MARKER **OFF** and MARKER **Δ**.
 31. Using the DATA knob, adjust the marker down one side of the displayed signal to the 7.3 dB point; CRT MKR A annotation indicates 0.430 X.
 32. Adjust **A4A9R66** 3 kHz for MKR A indication of 1.5 kHz while maintaining the marker at 0.430 X using the DATA knob. Refer to Figure 4-8 for the adjustment location.
 33. Press MARKER [a]. Adjust the marker to the 7.3 dB point on the opposite side of the signal (CRT MKR A annotation indicates 1.00 X).
 34. The CRT MKR [a] annotation now indicates the impulse bandwidth of the 3 kHz bandwidth. The impulse bandwidth should be 3.00 ±0.30 kHz

Option 857

Introduction

This chapter contains the modified amplitude fidelity performance test for Option 857 instruments. This chapter also contains the modified amplitude fidelity portion of the Test Record for Option 857 instruments.

8. Option 857 Amplitude Fidelity Performance Test

Related Adjustment Log Amplifier Adjustments

Specification Log:

Incremental

± 0.1 dB/dB over 0 to 80 dB display

Cumulative

3 MHz to 30 Hz Resolution Bandwidth:

$\leq \pm 0.6$ dB max over 0 to 70 dB display (20 to 30°C)

$\leq \pm 1.5$ dB over 0 to 90 dB display

10 Hz Resolution Bandwidth:

$\leq \pm 0.8$ dB over 0 to 70 dB display (20 to 30°C)

$\leq \pm 2.1$ dB over 0 to 90 dB display

Linear: $\pm 3\%$ of Reference Level for top 9 1/2 divisions of display

Description

Amplitude fidelity in log and linear modes is tested by decreasing the signal level to the spectrum analyzer in 10 dB steps with a calibrated signal source and measuring the displayed amplitude change with the analyzer's MARKER A function.

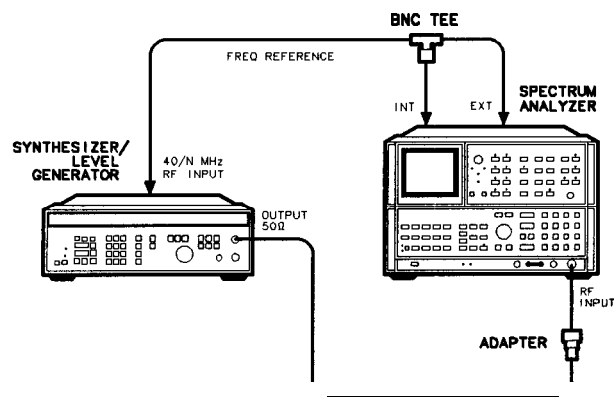

ga14b

Figure 5-1. Option 857 Amplitude Fidelity Test Setup

8. Option 857 Amplitude Fidelity Performance Test

Equipment	Frequency Synthesizer HP 3335A
	Adapter, Type N (m) to BNC (f) 1250-0780
	BNC Tee 1250-0781

Procedure Log Fidelity

1. On the spectrum analyzer, connect the CAL OUTPUT to the RF INPUT. Press **RECALL** 9 and adjust the FREQ ZERO pot for maximum amplitude.
2. Press **2 - 22 GHz** on the analyzer. Key in analyzer settings as follows:

CENTER FREQUENCY	20 MHz
FREQUENCY SPAN	100 Hz
REFERENCE LEVEL	+ 10 dBm
3. Set the frequency synthesizer for an output frequency of 20.000 MHz and an output power level of + 10 dBm. Set the amplitude increment for 10 dB steps.
4. Connect equipment as shown in Figure 5-1.
5. Press MARKER **PEAK SEARCH**, **MKR → CF**, **MKR → REF LVL** to center the signal on the display.
6. Press SWEEP **SINGLE** on the spectrum analyzer and wait for the sweep to be completed.
7. Press MARKER **PEAK SEARCH**, MARKER **Δ**. Step the frequency synthesizer output amplitude down 10 dB.
8. On the spectrum analyzer, press SWEEP **SINGLE** and wait until the sweep is completed. Press MARKER **PEAK SEARCH**, and record the marker A amplitude (a negative value) in column 2 of Table 5-1.
9. Repeat steps 8 and 9, decreasing the output of the frequency synthesizer in 10 dB steps from -10 dBm to -80 dBm.
10. Subtract the value in column 1 from the value in column 2 for each setting to find the fidelity error.
11. Subtract the greatest negative fidelity error from the greatest positive fidelity error for calibrated amplitude steps from -10 dB to -70 dB. The results should be $\leq \pm 0.8$ dB.
 _____ dB
12. Subtract the greatest negative fidelity error from the greatest positive fidelity error for calibrated amplitude steps from -10 dB to -90 dB. The results should be $\leq \pm 2.1$ dB.
 _____ dB
13. Set the frequency synthesizer amplitude to + 10 dBm.

8. Option 857 Amplitude Fidelity Performance Test

14. Key in the following analyzer settings:

FREQUENCY SPAN 100 kHz
RES. BW 10 kHz
 SWEEP **CONT**

15. Press **MARKER** (**PEAK SEARCH**), (**MRK → CF**), (**MRK → REFLVL**) to center the signal on the display.

16. Key in the following analyzer settings:

FREQUENCY SPAN 0 Hz
VIDEO BW 1 Hz

17. Press **MARKER A**. Step the frequency synthesizer output amplitude from + 10 dBm to -80 dBm in 10 dB steps, noting the **MARKER A** amplitude (a negative value) at each step and recording it in column 2 of **Table 5-2**. Allow several sweeps after each step for the video filtered trace to reach its final amplitude.

18. Subtract the value in column 1 from the value in column 2 for each setting to find the fidelity error.

19. Subtract the greatest negative fidelity error from the greatest positive fidelity error for calibrated amplitude steps from -10 dB to -70 dB. The result should be ≤ 0.6 dB

_____ dB

20. Subtract the greatest negative fidelity error from the greatest positive fidelity error for calibrated amplitude steps from -10 dB to -90 dB. The result should be ≤ 1.5 dB

_____ dB

Table 5-1.
Log Amplitude Fidelity (10 Hz RBW; Option 857)

Frequency Synthesizer Amplitude (dBm)	1 Calibrated Amplitude Step	2 MARKER A Amplitude (dB)	Fidelity Error (Column 2 - Column 1) (dB)
+10	0 (ref)	0 (ref)	0 (ref)
0	-10	_____	_____
-10	-20	_____	_____
-20	-30	_____	_____
-30	-40	_____	_____
-40	-50	_____	_____
-50	-60	_____	_____
-60	-70	_____	_____
-70	-80	_____	_____
-80	-90	_____	_____

8. Option 857 Amplitude Fidelity Performance Test

Table 5-2.
Log Amplitude Fidelity (10 kHz RBW; Option 857)

Frequency Synthesizer Amplitude (dBm)	1 Calibrated Amplitude Step	2 MARKER A Amplitude (dB)	Fidelity Error (Column 2 - Column 1) (dB)
+10	0 (ref)	0 (ref)	0 (ref)
0	-10	_____	_____
-10	-20	_____	_____
-20	-30	_____	_____
-30	-40	_____	_____
-40	-50	_____	_____
-50	-60	_____	_____
-60	-70	_____	_____
-70	-80	_____	_____
-80	-90	_____	_____

Linear Fidelity

21. Key in analyzer settings as follows:

..... 300 Hz
 20 kHz
 10 kHz

22. Set the frequency synthesizer for an output power level of + 10 dBm.

23. Press SCALE LIN pushbutton. Press MARKER , to center the signal on the display.

24. Set to 0 Hz and to 1 Hz. Press (SHIFT), ^A (resolution bandwidth), MARKER .

25. Decrease frequency synthesizer output amplitude by 10 dB steps, noting the MARKER A amplitude and recording it in column 2 of Table 5-3.

Table 5-3. Linear Amplitude Fidelity

Frequency Synthesizer Amplitude (dBm)	MARKER A Amplitude (dB)	Allowable Range (±3% of Reference Level) (dB)	
		Min	Max
0	_____	-10.87	-9.21
-10	_____	-23.10	-17.72

Performance Test Record

Hewlett-Packard Company	Tested by _____
Model HP 8566B	Report No. _____
Serial No. _____	Date _____
IF-Display Section _____	
RF Section _____	

**Test 8. Option 857
Amplitude Fidelity**

Step 9. Log Amplitude Fidelity (10 Hz RBW)

Frequency Synthesizer Amplitude (dBm)	1 Calibrated Amplitude Step	2 MARKER A Amplitude (dB)	Fidelity Error (Column 2 - Column 1) (dB)	Cumulative Error 0 to 70 dB (dB)	Cumulative Error 0 to 90 dB (dB)
+ 10	0 (ref)	0 (ref)	0 (ref)		
0	-10	_____	_____	_____	_____
-10	-20	_____	_____		
-20	-30	_____	_____		
-30	-40	_____	_____		
-40	-50	_____	_____		
-50	-60	_____	_____		
-60	-70	_____	_____		
-70	-80	_____	_____		
-80	-90	_____	_____	≤±0.8 dB	≤±2.1 dB

Step 18. Log Amplitude Fidelity (10 kHz RBW)

Frequency Synthesizer Amplitude (dBm)	1 Calibrated Amplitude Step	2 MARKER A Amplitude (dB)	Fidelity Error (Column 2 - Column 1) (dB)	Cumulative Error 0 to 70 dB (dB)	Cumulative Error 0 to 90 dB (dB)
+ 10	0 (ref)	0 (ref)	0 (ref)		
0	-10	_____	_____	_____	_____
-10	-20	_____	_____		
-20	-30	_____	_____		
-30	-40	_____	_____		
-40	-50	_____	_____		
-50	-60	_____	_____		
-60	-70	_____	_____		
-70	-80	_____	_____		
-80	-90	_____	_____	≤±0.6 dB	≤±1.5 dB

Test 8. Option 857 Amplitude Fidelity

Step 26. Linear Amplitude Fidelity

Frequency Synthesizer Amplitude (dBm)	MARKER A Amplitude (dB)	Allowable Range (±3% of Reference Level) (dB)	
		Min	Max
0		-10.87	-9.21
-10		-23.10	-17.72

Major Assembly and Component Locations

IF-Display Section Figure Index	Assembly	See Figure
	A1A1	6-6
	A1A2	6-4, 6-5
	A1A3	6-4; 6-5
	A1A4	6-4
	A1A5	6-4
	A1A6	6-4, 6-5
	A1A7	6-4, 6-5
	A1A8	6-4, 6-5
	A1A9	6-4, 6-5
	A1A10	6-7
	A1A10C1	6-4, 6-5
	A1A10C2	6-4, 6-5
	A1A10C3	6-4, 6-5
	A1A10C4	6-4, 6-5
	A1A11	6-4
	A1T1	6-4, 6-5 6-7
	A1V1	6-4, 6-5 6-6, 6-7
	A3A1	6-4, 6-5
	A3A2	6-4, 6-5
	A3A4	6-4, 6-5
	A3A5	6-4, 6-5
	A3A6	6-4, 6-5
	A3A7	6-4, 6-5
	A3A8	6-4, 6-5
	A3A9	6-4, 6-5
	A3A10	6-7
	A4A1	6-4, 6-5
	A4A2	6-4, 6-5
	A4A3	6-4, 6-5
	A4A4	6-4, 6-5
	A4A5	6-4, 6-5
	A4A6	6-4, 6-5
	A4A7	6-4, 6-5
	A4A8	6-4, 6-5
	A4A9	6-4, 6-5
	A4A10	6-7
	FL1	6-4, 6-5
	W1	6-6
	w2	6-6
	w3	6-6
	W6	6-4
	W7	6-4
	W8	6-6, 6-7
	W9	6-6
	W21	6-4, 6-5

W23	6-7
W24	6-7
W25	6-7
W26	6-7
W27	6-7
W28	6-7
W29	6-7
W32	6-7

RF Section Figure Index

Assembly	See Figure
A5A1	6-2
A5A2	6-2
A5SW1	6-2
A6	6-3
A6A6	6-1
A6A13	6-1
A6J1	6-2
A6J2	6-2
A6J3	6-2
A6J4	6-2
A6J5	6-2
A6R1	6-2
A7	6-3
A8	6-3
A11	6-3
A12	6-3
A15	6-3
A16	6-3
A17	6-3
A18	6-3
A19	6-3
A20	6-3
A21	6-3
A22	6-3
A23	6-1
A23C1	6-1, 6-3
A23C2	6-1, 6-3
A23C3	6-1, 6-3
A23C4	6-1, 6-3
A23Q1	6-1
A23Q2	6-1
A23Q3	6-1
A23Q4	6-1
A23W5	6-1, 6-2
A23W6	6-1
A23W7	6-1, 6-2
A23U1	6-1
A24	6-1
T1	6-3
W15	6-1

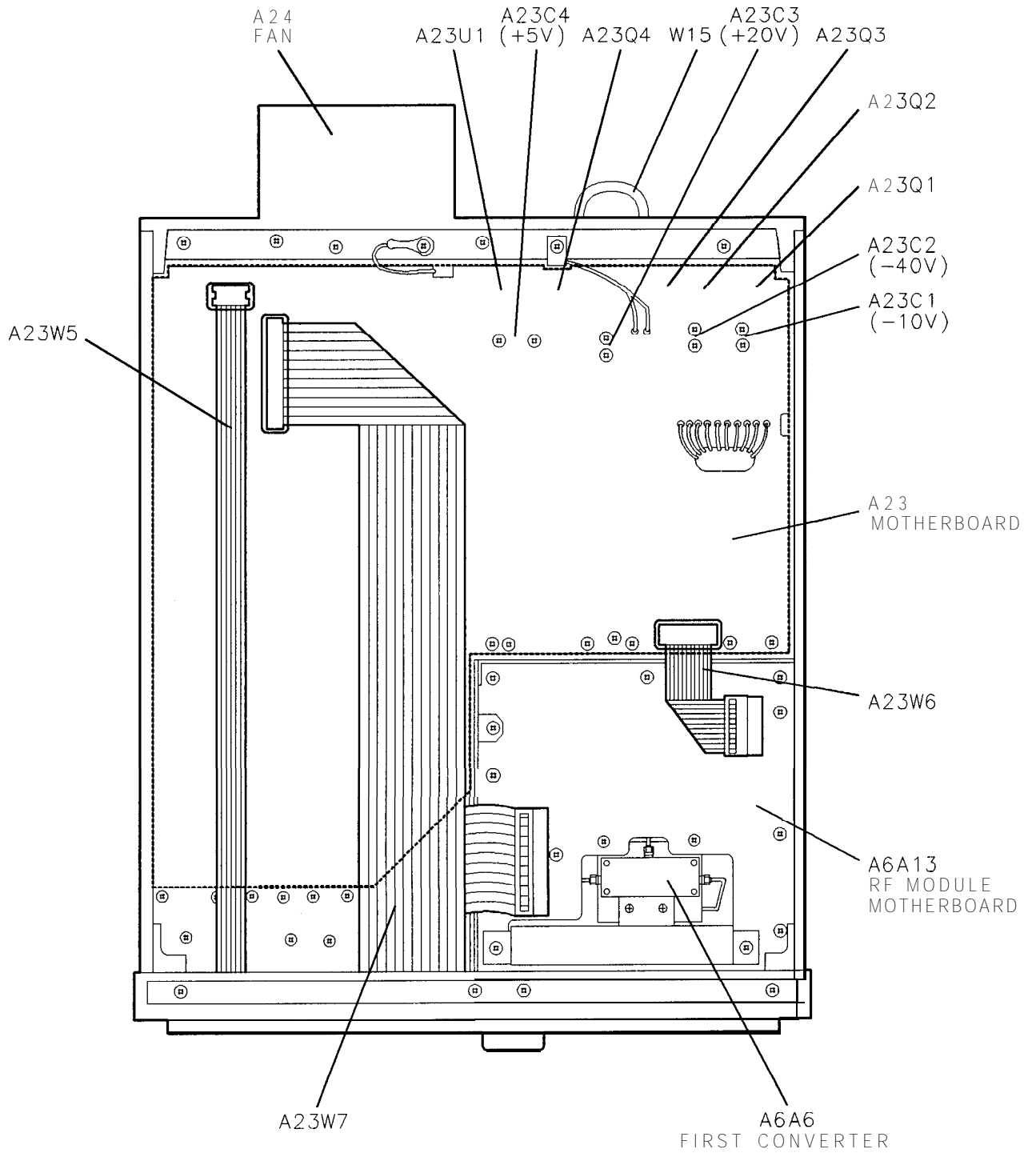

Figure 6-1. RF Section, Top View

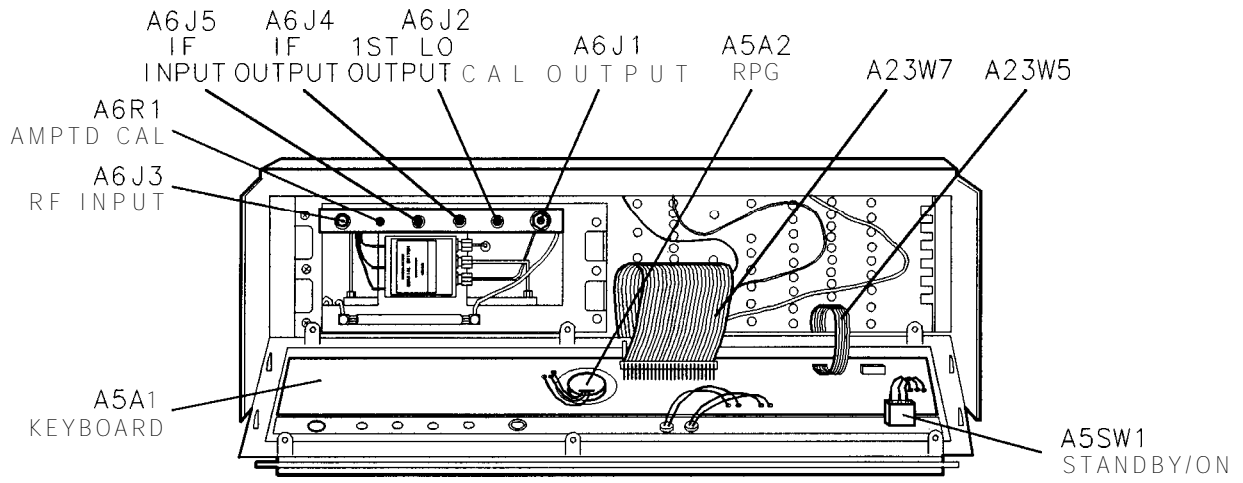

Figure 6-2. RF Section, Front View

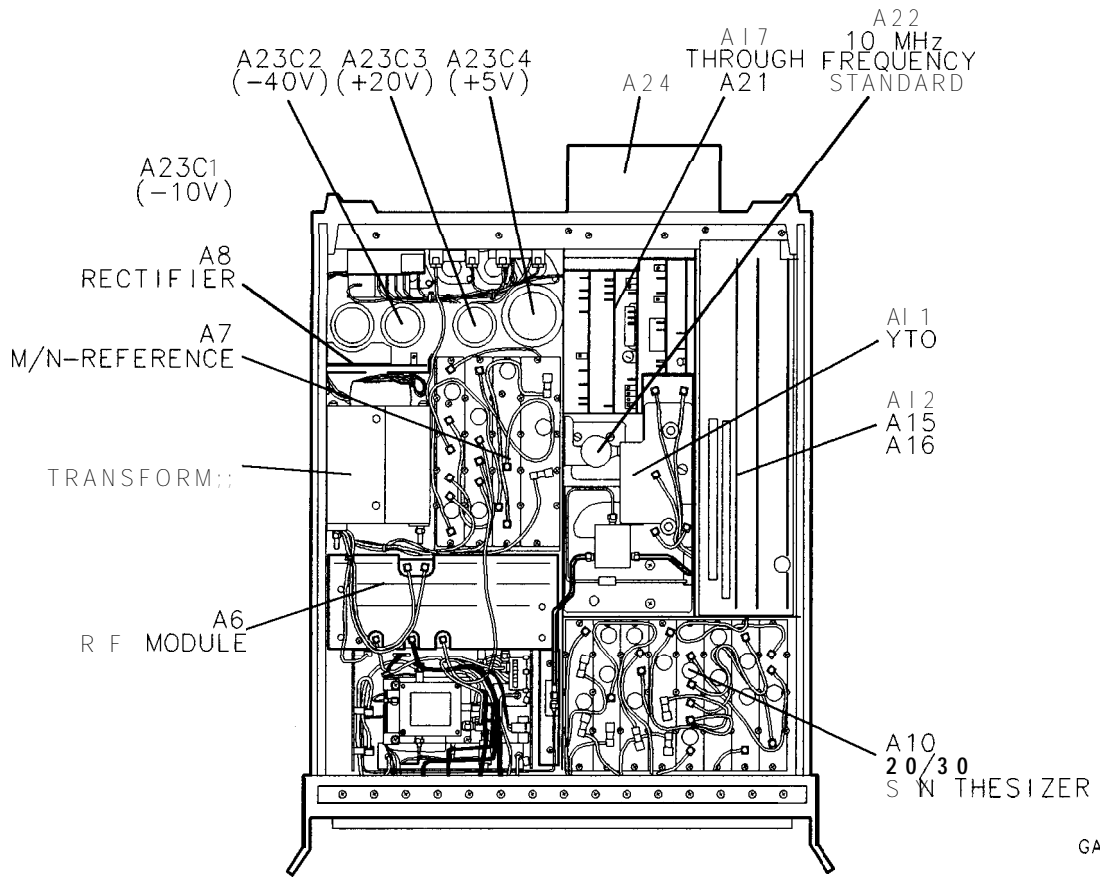

Figure 6-3. RF Section, Bottom View

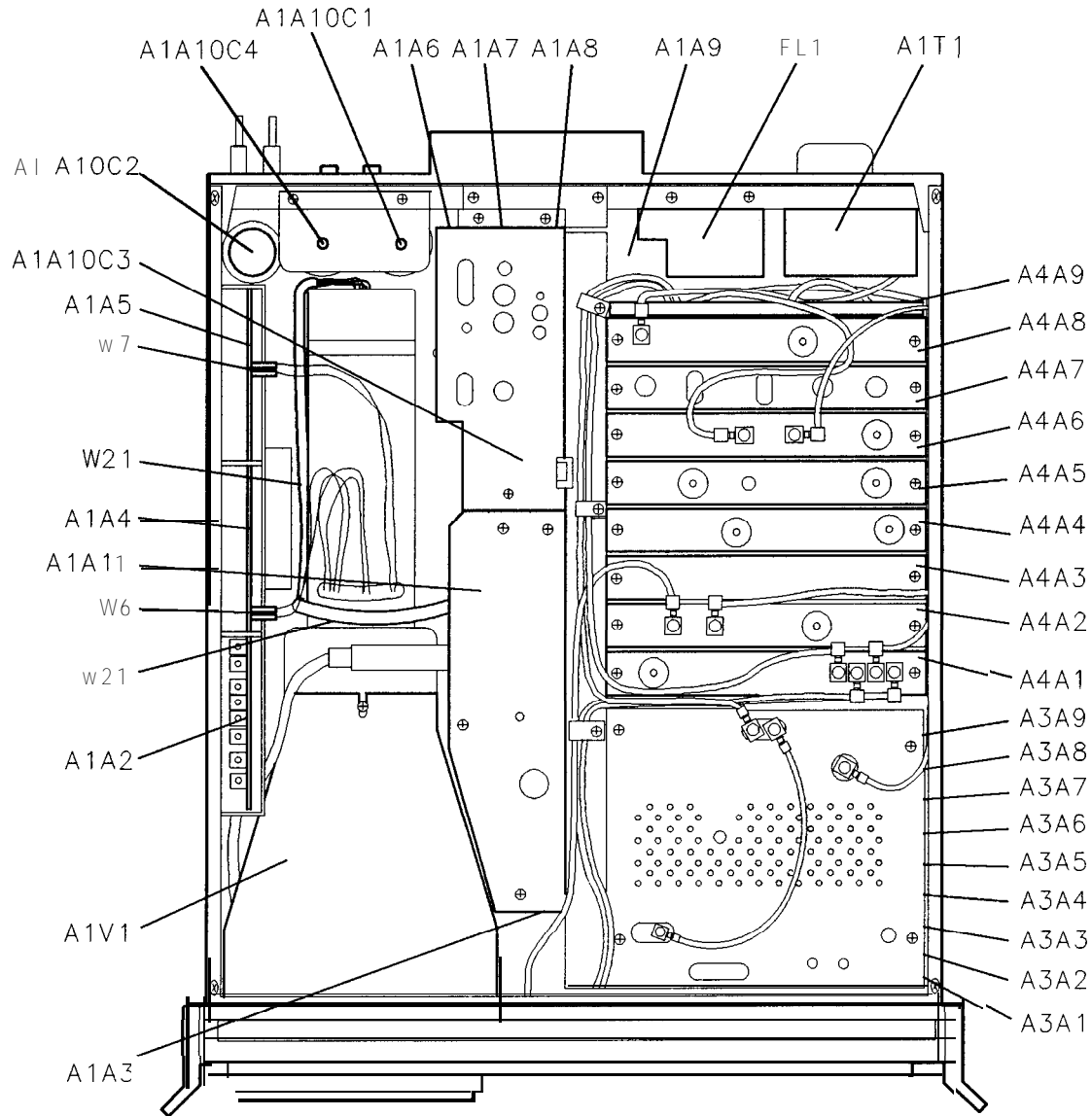

Figure 6-4. IF Section, Top View (SN 3001A and Below)

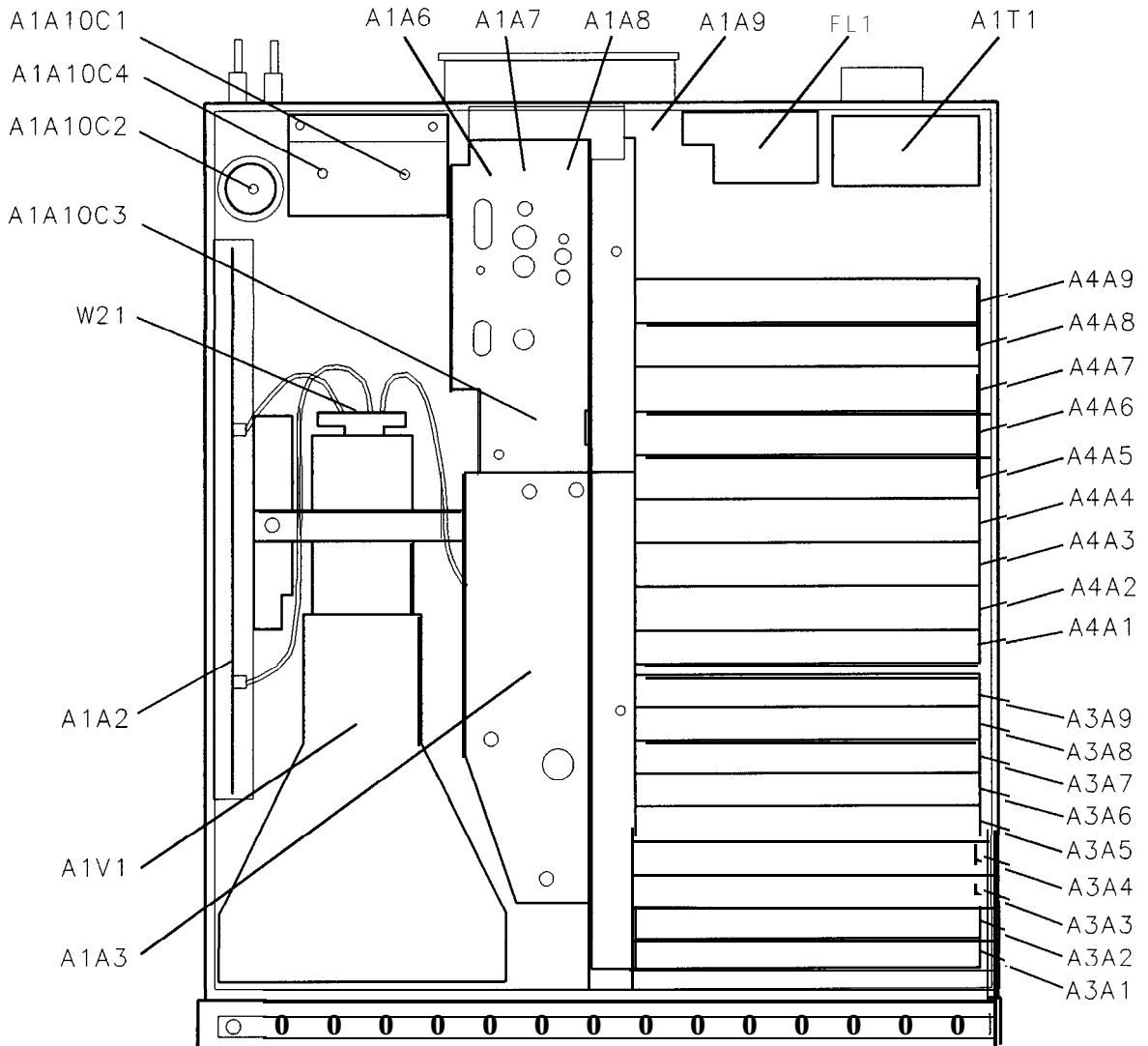

Figure 6-5. IF Section, Top View (SN 3004A and Above)

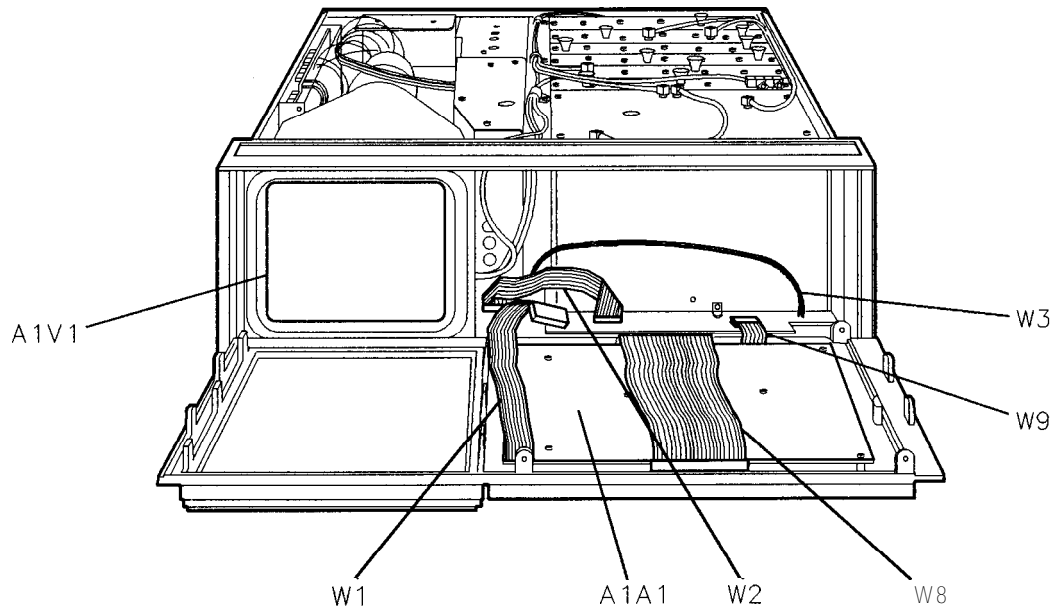

Figure 6-6. IF Section, Front View

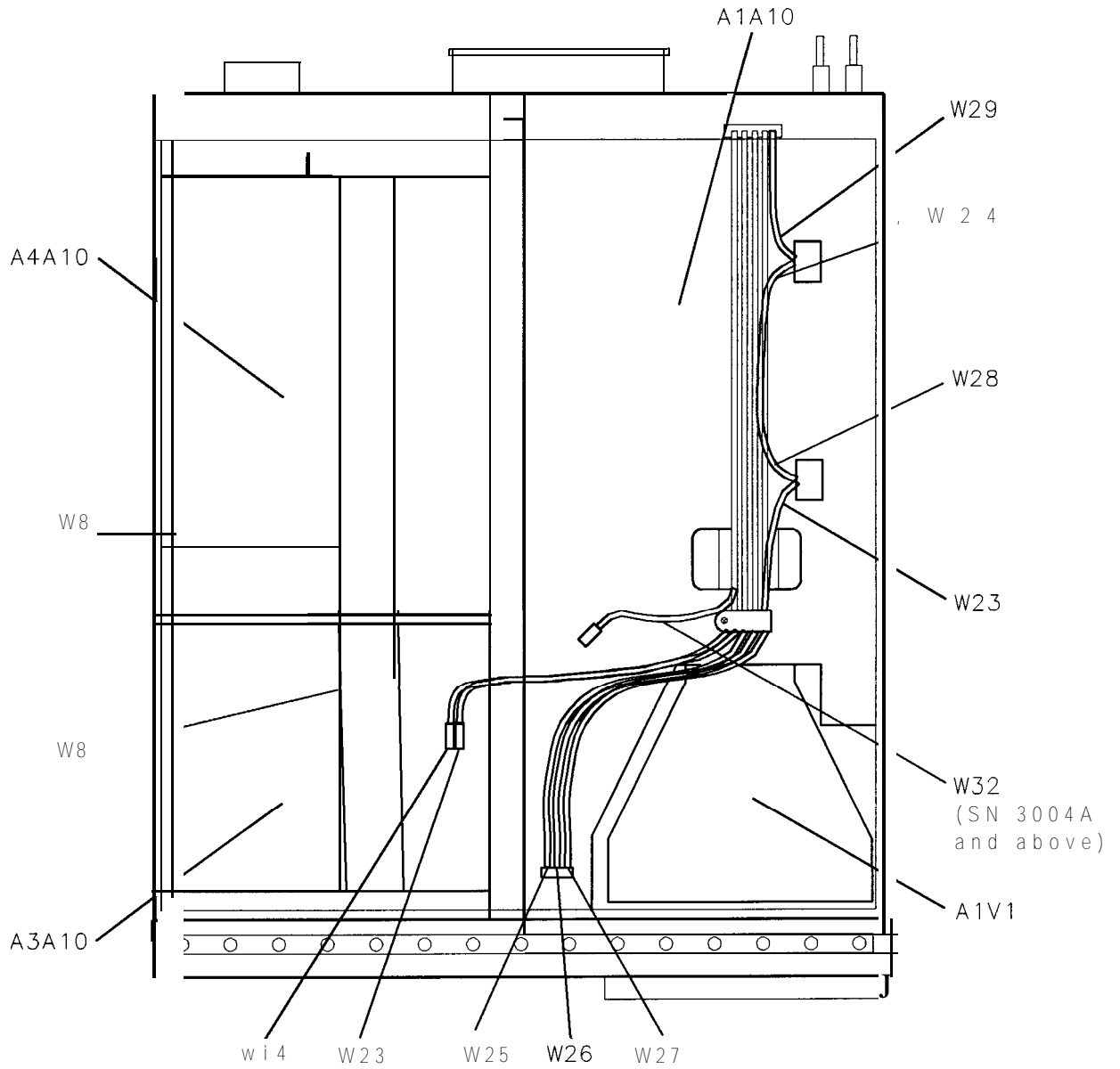

Figure 6-7. IF Section, Bottom View